



Pulsonix Design System Users Guide

Copyright Notice

Copyright © WestDev Ltd. 2001-2023

Pulsonix is a Trademark of WestDev Ltd. All rights reserved. E&OE

Copyright in the whole and every part of this software and manual belongs to WestDev Ltd. and may not be used, sold, transferred, copied or reproduced in whole or in part in any manner or in any media to any person, without the prior written consent of WestDev Ltd. If you use this manual you do so at your own risk and on the understanding that neither WestDev Ltd. nor associated companies shall be liable for any loss or damage of any kind.

WestDev Ltd. does not warrant that the software package will function properly in every hardware software environment.

Although WestDev Ltd. has tested the software and reviewed the documentation, WestDev Ltd. makes no warranty or representation, either express or implied, with respect to this software or documentation, their quality, performance, merchantability, or fitness for a particular purpose. This software and documentation are licensed 'as is', and you the licensee, by making use thereof, are assuming the entire risk as to their quality and performance.

In no event will WestDev Ltd. be liable for direct, indirect, special, incidental, or consequential damage arising out of the use or inability to use the software or documentation, even if advised of the possibility of such damages.

WestDev Ltd. reserves the right to alter, modify, correct and upgrade our software programs and publications without notice and without incurring liability.

Microsoft, Windows, Windows NT and Intellimouse are either registered trademarks or trademarks of Microsoft Corporation.

All other trademarks are acknowledged to their respective owners.

Pulsonix, a division of WestDev Ltd.

Printed in the UK.

Issue date: 23/06/23 Issue 1

Pulsonix
20 Miller Court
Severn Drive
Tewkesbury
Glos, GL20 8DN
United Kingdom

Technical +44 (0)1684 296 570

Sales +44 (0)1684 296 551

Email sales@pulsonix.com

Web www.pulsonix.com

Contents

CONTENTS	5
CHAPTER 1. GETTING STARTED	13
Welcome	13
About this Manual.....	13
The contents of this manual.....	13
Where to find additional information	13
System Requirements	13
Hardware required.....	13
Program security	14
Installation.....	14
For new users (normal installation).....	14
Moving the Installation	15
Updating Pulsonix from the web.....	15
Updating Pulsonix Using Hot Fixes	15
Floating Network Licensing.....	15
Uninstalling Pulsonix	16
Contacting Technical Support Resources	16
CHAPTER 2. USING PULSONIX.....	17
Introduction to Pulsonix	17
Starting Pulsonix	17
The Status Bar	18
The On-line Help System	20
Customising Pulsonix.....	20
Overview.....	20
Light and Dark UI.....	20
Toolbars	21
Commands and Shortcuts.....	23
Dockable Windows and Browsers.....	24
Overview.....	24
Component Bin	25
Part Browser.....	27
World-view	29
Design Browser.....	29
DRC and ERC Error Browsers.....	30
Layers.....	31
Find.....	33
The Item Filter in Browser Windows	35
Selection Mask Window	36
Inspector Bar (Dynamic Properties)	37
Other Browser Bars Available	40
Attribute Editor	41
Mouse Operation	43
Viewing the Design.....	43
Design Item Selection	44
Context menus.....	49
The Design Settings Dialog.....	50
The Options Dialog	50

The Properties Dialog.....	51
CHAPTER 3. GENERAL UTILITIES	55
Undo/Redo	55
Interactive Operations	55
Moving Items	55
Mirror	57
Rotating Items	58
Lock and Unlock	61
Cut, Copy, Paste and Duplicate	62
Grouping Items.....	64
Deleting Items	65
Inserting Text	67
Mitring and Filleting Corners	72
CHAPTER 4. SETTING UP THE DESIGN	75
Overview	75
Using Folders and Files	75
Folders.....	75
Files.....	78
Security Copies and Backups	79
Units	82
Grids.....	82
Changing the Design Area Size.....	86
Changing the Design Origin	86
Changing the Design Origin.....	86
Working in Absolute and Relative Modes.....	87
Changing the Relative Coordinate origin	87
Technology Files	88
Creating and saving Technology files	89
Styles.....	90
Introduction to Net Items	91
Net Styles.....	92
Rules	93
What is a rule?.....	93
Creating and applying Rules	94
Wildcard Wizard	95
Colours.....	97
Load Technology.....	98
Profile Files	100
Design Defaults	101
Working With Attributes.....	102
The Pulsonix Vault.....	111
Key Concepts of the Vault	112
What can be stored in the Vault?.....	112
What is an 'item'?	112
Other Vault item properties.....	113
Cross References.....	113
Managing and updating Vault items.....	113
Vault Admin Tools.....	114
Adding Vault Items to a Design	114
CHAPTER 5. SCHEMATIC CAPTURE EDITOR	115
Getting Started.....	115
Starting a New Drawing with Default Files.....	115
Design Options for Schematic Design.....	116

Setting up your Technology	118
Schematic Technology dialog	119
Rules	120
Changing the Colours of the Schematic	120
Using a Drawing Profile (Page Border).....	121
Using the Component Bin	122
Adding Components.....	123
Using Decoupling Capacitors.....	127
Adding Connectors.....	128
Reloading Parts	130
Adding Connections to the Design.....	131
Add Connection Modes.....	141
Naming and Renaming Nets.....	143
Local and Global Nets.....	143
Defining Track & Vias styles in SCM and Translated to PCB.....	144
Electrical Rules Checking (ERC).....	146
ERC Modes of operation.....	146
Defining the Rules.....	148
Pin Type Rules.....	148
The ERC Error Browser.....	150
Documentation Symbols	151
Overview.....	151
Using 'general' Doc Symbols	152
Block Ports.....	153
Block Symbols.....	154
Block Port and Blocks.....	154
Branch Points	154
Bus References.....	155
Documentation Symbols	155
Mounting Holes.....	155
Net Labels	156
Page Link	156
Signal References.....	158
Power and Ground Symbols.....	159
Cross Sheet References	160
Star Points	161
Testpoints.....	161
Using Busses	161
Hierarchy.....	168
What is hierarchy and why use it?.....	168
Overview of Hierarchy.....	168
Connecting Through Hierarchy.....	170
Setting up your design for hierarchy	171
Creating a new block to add to your design	173
Blocks, Pin Types and ERC	176
Using an existing Hierarchical Block in the Design.....	177
Creating a Hierarchical Block from an existing Schematic Design.....	178
Cutting an existing Schematic Circuit to a block	179
Adding More Pages to the Design.....	184
Combining Schematic Pages from other Designs.....	185
Building up the Design using Copy and Paste.....	185
Resolving Net Names when using Paste.....	185
Using Testpoints.....	187
Adding Shapes.....	188

Use of Attributes in Schematic Capture	189
Translating the Schematic to PCB	189
Exporting Netlists	191
Exporting Spice Netlists	192
Reverse Engineer	193
Printing and Plotting the Schematic Design	194
Using the Print Option	194
Using the CAM/Plot option	195
Printing to Active PDF	201
CHAPTER 6. PCB DESIGN EDITOR	205
Getting Started with the Design	205
Starting a New PCB Layout with Default Files	205
Design Setup for PCB Layout	206
Setting up a PCB Technology	208
PCB Technology dialog	208
Styles	208
User Defined Pad Shapes	211
Hatch Styles	214
Style Naming Rules Pages in the Technology Dialog	215
Spacing Rules	217
Special Design Level Rules	218
Match Pair Level Rules	218
Import Spacings Rules using CSV Format Files	219
DFM/DFT Rules	220
CAM Plot	222
Layers	222
Layer Classes	224
Materials	225
Layer Spans	226
Displaying Layer Stacks	227
Changing the Colours in the PCB	228
Translating from Schematics	229
Importing a Netlist	229
Creating a Board Outline	230
Insert Mounting Holes	232
Using Profile Files	233
Setting the Design Origin	235
Inserting Components	235
Reloading Parts	238
Using the Component Bin	240
Moving Components to/from the Bin	241
Placing Components around the Board Outline	244
On-line Design Rules Checking (DRC)	245
Placing Components interactively	248
Adding Connections	255
Managing PCB Nets	257
Optimising Nets	260
Manual Gate and Pin Swapping	260
Manually Routing the Design	263
Track Breakouts (Fanouts)	281
Using the AutoDim option	283
Unrouting Tracks	284
Using Shapes and Cutouts	284
Shapes	284

Areas	295
Merging Shapes.....	297
Cutouts	297
Board Cutouts	298
Inserting Copper.....	299
Pouring Copper and Templates	302
Using Teardrops	309
Adding Dimensions.....	311
Adding Dimensions.....	313
Text Callouts	317
Attached Callouts.....	318
Measure Tool.....	319
Using PCB Attributes.....	321
Design Rules Checking	322
Locating Errors	325
Synchronising The Designs	326
Full ECO Back to the Schematic.....	327
Cross Probing Designs	329
Printing the Design.....	331
Assembly Variants	332
Components in Variants	334
Fitted Component Variants	337
Part Variants.....	338
Component Variant Attributes	339
Variant Attributes.....	339
Using the Database with Part Variants.....	341
Other considerations for Variants.....	342
Using 'Instances' for Variants.....	344
Variants Spreadsheet Editor	345
Micro-vias and Layer/Component Span Technology	346
Micro-via Layer 'Facing' Switch.....	346
Layer Spans.....	347
Composite Micro-via Layer Spans.....	348
Defining a Composite Via Span in Net Styles.....	348
Using Composite Layer Spans	349
Stacked and Tapered Micro-vias	349
Outputs for drilling Micro-vias	351
Advanced Technology Features	351
Autorouting	351
Interactive High Speed Design.....	351
CHAPTER 7. OUTPUTS FOR PCB MANUFACTURING	353
Overview of manufacturing outputs.....	353
The CAM Plot option.....	354
Using the CAM/Plot option.....	354
Outputting a plot overview.....	354
Outputting a Windows Print to File and PDF.....	354
Auto Generate Plots	354
The CAM/Plot dialog	355
Step & Repeat	358
Plotting Variants.....	359
Plot Groups	360
Using the Plot Wizard	360
Drill Sizes.....	366
Manufacturing Outputs.....	368

Creating the plot types.....	368
Types of manufacturing plots.....	370
Adding the board outline to plots.....	370
Composite Power planes.....	379
Creating Split power planes.....	381
Breaking Silkscreen.....	383
Creating an output for NC Drilling machines.....	384
Outputting Drill drawings.....	385
Combining plots.....	390
Plot Transformations and Positioning in Plot Preview.....	391
Check Plots.....	393
Using Fiducial Marks.....	393
Outputting other formats using the CAM Plot dialog.....	394
Additional Manufacturing Exports using the Output menu.....	394
Outputting to Mechanical CAD Systems.....	396
Outputting for Documentation.....	396
Outputting to ZIP Format.....	397
CHAPTER 8. OUTPUTTING REPORTS, PART AND NET LISTS	399
Standard Reports.....	399
Report Maker.....	400
Advanced Format Scripts.....	407
CHAPTER 9. IMPORTING DESIGNS AND LIBRARIES.....	413
Overview.....	413
Importing Alien Designs.....	413
Importing Netlists into Pulsonix PCB.....	414
Importing Other Formats.....	416
Importing Gerber files.....	416
Importing DXF files.....	416
Importing IDF Files.....	417
Importing STEP Files.....	417
How to import DXF/IDF/Gerber files.....	418
How to import using the Intelligent Gerber option.....	418
CHAPTER 10. LIBRARY MANAGEMENT TOOLS	419
Understanding Pulsonix Libraries.....	419
Libraries Overview.....	422
Overview of the Supplied Libraries.....	423
Additional Library Content.....	424
The Library Manager.....	425
Overview.....	425
Library folders.....	425
Using the Library Manager.....	427
Library Selection.....	428
Merging Libraries.....	430
Creating Schematic Symbols.....	430
Using the Symbol Editor.....	431
Library Creation Wizards.....	439
Creating PCB Footprints.....	439
Using the Footprint Editor.....	440
Breakouts in the Footprint.....	449
Creating Parts.....	451
Part entity correlation.....	452
Using Part Technology Files.....	453
Creating Basic Parts.....	453

Associated Parts	468
Creating Unusual Parts.....	470
Documentation Symbols	471
Pulsonix Database Connection (PDC).....	471
Pulsonix Vault.....	471
INDEX	472

Chapter 1. Getting Started

Welcome

Welcome to the Pulsonix electronic design system. The system is built on an integrated design environment providing all the tools required to capture a schematic and simulate it using the Spice simulator interfaces, through to the design and layout of the printed circuit board (PCB) which is aided with a powerful shape-based auto router.

Pulsonix appeals to all users, from the casual to the full time user because of its simplicity and straightforward approach. Pulsonix is structured in such a way that its menu structure and options naturally leads you through the design sequence, that in turn means you don't 'jump' about within the product hunting for functionality.

About this Manual

The contents of this manual

Like all aspects of Pulsonix, the Users Guide has been written to be as usable as possible with the least amount of effort. It has been produced in a manner that will get you started in the quickest time possible by describing functionality based on the logical steps of a practical design cycle. Even if your design cycle doesn't follow the exact path in this manual you can get your questions answered by turning to the relevant sections. The manual does not take you through every detail but will guide you through the essentials to produce a design. The on-line help provides further information in context about each option. It is directed at users who understand the fundamentals of designing PCBs; it is not intended as a course in designing PCBs.

Where to find additional information

Additional information and help located in the accompanying HTML on-line help system. Once the Pulsonix product has been installed and is running, you can call help at any time by locating the Help index from the Help menu and selecting one of the options available.

System Requirements

Hardware required

To run Pulsonix your PC hardware will need to conform to the following requirements:

- A Pentium class processor (i7 minimum or better recommended)
- Microsoft Windows 10 or 11 recommended *
- At least 8Gb of RAM minimum
- Graphics to support DirectX 10
- 1.4Gb of hard disk space for the all files supplied, including libraries and run time files
- 3 button mouse with wheel is recommended although any mouse will work

** It is highly recommended that the most up-to-date Windows operating systems are always used. Please check our web site for the Pulsonix operating system support policy.*

Program security

The Pulsonix design system is protected by a security key or network address, plus an accompanying license code. The key is attached to the USB port for a node-locked system; you may also use a Network Address to replace the security key. If using this protection, a key would not have been supplied. For ‘floating’ network license systems the license resides on a server system, this will also be paired with a MAC address or USB key.

If updating or upgrading your program from an earlier version you may require a new license. You will be supplied a new license if needed and you will be informed of the procedure to use it.

Installation

For new users (normal installation)

To install any of the Pulsonix products, as a standard precaution we recommend that you first close all other applications, saving your work if necessary.

This procedure is used for any ‘client’ installation, that is, an installation which is not using a network license scheme and for which the dongle resides on the same machine. For floating network licensing refer to the *Network Licensing Installation Guide*.

USB Key Driver

You must NOT connect the USB key (dongle) before installation is attempted. Once Pulsonix has been installed you will need to connect it. The Setup program will install a special **HASP USB Key driver** to use. Once Pulsonix is installed and the USB key attached, Windows will automatically detect the key and will use the new supplied driver. You cannot use the standard Windows Plug & Play driver.

Licensing

Normally, the license file will be supplied to you by email with the name *license.lic* or *key_number.lic* This license file includes any products and cost options purchased. Create a suitable folder and save it into this on your hard drive. During installation you will be asked to browse to it. You can use this location if changing from a **Trial** system to the licensed product once purchased. You can also use the **License Manager** to browse to the location of the license file if switching between the trial system and an evaluation license.

MAC Address License

A license may also be supplied to you that is locked to your computer’s MAC address. This is an alternative to using a USB key security mechanism. The procedure for installation will be exactly the same as with the USB key detailed above.

Installation from a download

If you have been provided with a download link to install Pulsonix from the Pulsonix web site, click on the link provided. This download a packed executable file which will run once **setup** has been double clicked.

The **Pulsonix Setup Wizard** will guide you through installation of the software. Follow the steps displayed on-screen and press the <Next> or <Back> buttons to move through each stage. If you need to, you can abandon the installation at any time by clicking on the **Cancel** button and then **Exit**.

All the Installation Notes and User’s Guides are available from the Pulsonix.com web site.

Moving the Installation

If you wish to move Pulsonix from one machine to another, you cannot simply copy the installation, you must use the program executable file to re-install it. The Setup program must be used in order to install the required registry entries. You can move your Pulsonix settings from one machine to another Saving and Loading Configuration files. This is described in mor edetail in the online help.

Updating Pulsonix from the web

Pulsonix can be automatically updated through our web site with the latest fixes that become available from our development centre. This facility is available for all users with a current maintenance contract and a login account.

To check and access the latest patches from the web site, from within Pulsonix, go to the **Help** menu and select **Check For Updates...** When selected, a dialog is displayed, this allows you to set up when you want to check for updates and where to check. It also allows you to force a check now. This will automatically direct you to the Pulsonix Updates page from where you can login and download the latest patch available.

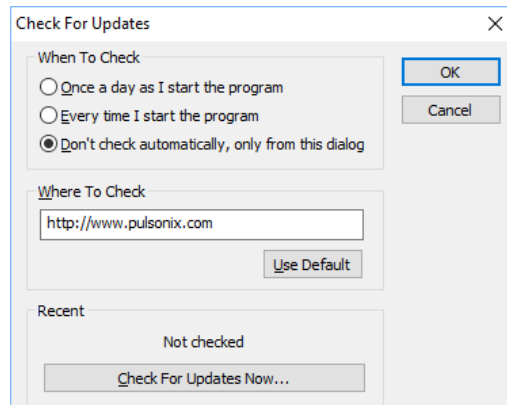

If a patch isn't available, the dialog will report that none are available at this time. Before installing a new patch, ensure that Pulsonix isn't running, if it is, it must be closed.

You can also save the executable file to your local disk if you wish to install it at a later time or on another machine or over a local intranet network onto several machines.

Updating Pulsonix Using Hot Fixes

Occasionally, there is the need to fix critial issues before a service patch is released. A hot fix is issued to accommodate this in the form of a self-extracting executable that you would have been sent a link for in an email from our service centre. This will fix your issue until the next patch is released.

Floating Network Licensing

Floating network licensing is the ability to run any number of licenses from one central server without the need for a dongle on each machine to run the product. This type of licensing effectively floats on the network until booked out by Pulsonix and used. Pulsonix supports this as a cost option to the regular product.

For installation instructions, an installation guide is supplied on the download page of our web site. Please refer to the **Network License Installation** notes for further information.

Uninstalling Pulsonix

To uninstall the product from your hard drive you should use the **Remove** option from the main **Installation** program. For product updates or upgrades you do not need to uninstall existing product first regardless of its version.

Contacting Technical Support Resources

Access to our support engineers is available via the internet, e-mail and telephone (Monday to Friday 10:00am to 5:00pm in the UK). Outside this location please contact your local support centre.

Email: support@pulsonix.com

Phone: +44 (0)1684 296 570

Support is limited to: Installation assistance and questions regarding Pulsonix usage, design, manufacturing and library design, all answered in context of how to use the features. Consultancy is also available, for more information about this service, please contact our international sales office. After your free support has expired, extended support options can be purchased from our sales office.

Whenever our technical desk is contacted, you will need to have your contact details (phone and email address) available, plus the product version number. It helps us and speeds up the process if any problems can be reproduced on our demo designs supplied.

Please note that we can only support the current major version, especially when attempting to reproduce problems.

Chapter 2. Using Pulsonix

Introduction to Pulsonix

Starting Pulsonix

The start location of the program can be set using the **Folders** option on the **Setup** menu. Please refer to the **Setting up The Design** Chapter, **Using Folders and Files**.

The Pulsonix Desktop

When you run Pulsonix, the main application window appears. Pulsonix operates a multiple document interface (MDI), so you can open any number and combination of different Pulsonix designs types, as well as libraries and additional tools.

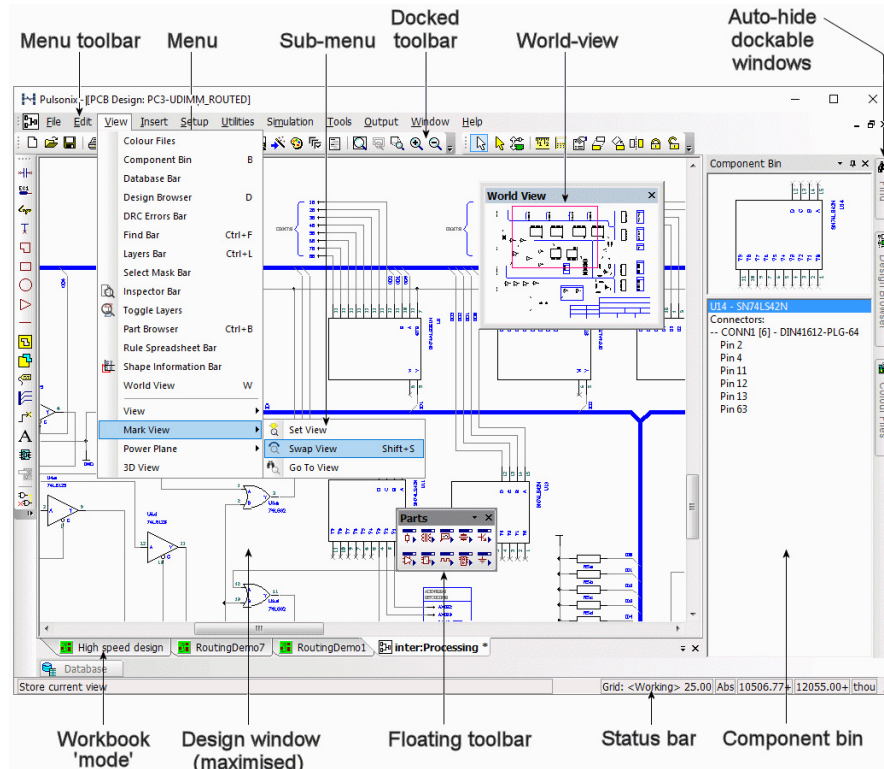

Pulsonix Menu Options

The Menu bar contains options relevant to each application open within Pulsonix. The menus are set out logically to be used as you move through the design cycle starting from the left and moving right. This methodology is only applicable if you are following this basic principle. The basic principle still applies regardless of where you start in your design cycle. The menus are logical and intuitive to understand. The menu bar is similar to a toolbar in that it can be 'docked' in place or left 'floating' on the screen as you wish.

Using Multiple Screens

Pulsonix can be used with more than one screen to provide you with Schematics on one and PCB on the other, for example. By default, Pulsonix is setup to use just the one screen but can be easily switched to use two.

► To enable multiple screen usage

1. If you wish to use more than one screen, from the **Tools** menu, select **Options**.
2. From the **Multi-Screen** tab, select either the **Enable Multi-Screen Support** check box.

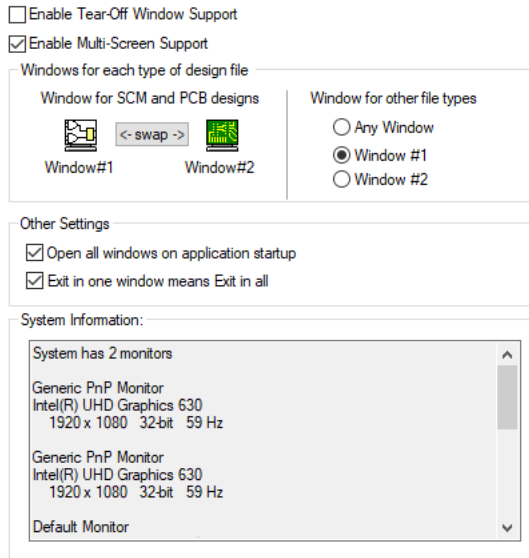

The Status Bar

The status bar appears across the bottom of the Pulsonix framework. The bar contains two sets of information; the **Prompt / Message** box displays useful information about the current activity and also provides basic instruction to its use. If an option doesn't behave as expected this area should be checked first to see what the system is expecting you to do, a prompt message is displayed in this area.



The Prompt/Message box is a single instruction box, the box to the right of this contains display **Property** information about any design items selected. The information in these boxes is not exhaustive but does contain commonly required information about the item selected. For more detailed information about any selected item, right click and click the **Properties** command from the context menu.

The status bar displays **Co-ordinate** information about the position of the cursor within the design as an X and Y co-ordinate value. These co-ordinates are shown as either **absolute [Abs]** or **relative [Rel]** depending on the mode selected. The current design Units are also shown on the status bar.

When viewing the X,Y co-ordinates on the status bar you will notice that they sometimes display a + or - sign after the each of the co-ordinate numbers. This indicates that the value shown cannot be represented using the current units precision.

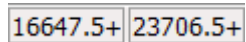

16647.5+ 23706.5+

The minus sign (-) (when displayed) indicates that the number is slightly less than the last digit shown, whereas the plus sign (+) indicates that the number is slightly more than the number shown. With the precision set in the Units dialog and the available space in the co-ordinate boxes this notation allows you to see instantly whether the number is precise or not.

If using **Relative** co-ordinates, the status bar shows the co-ordinates relative to the relative origin. This will only return back to co-ordinates relative to the design origin if the system is swapped back to an **Absolute** co-ordinate system. Use the **Design Properties** dialog located on the **Edit** menu to switch modes and change the relative origin.

The furthest box to the right displays the current design **Units**.

Active Status Bar

The Status bar is also active. This means that by double-clicking on a pane within it, relevant information can be modified. For example, clicking on the **Abs** word will toggle between **Absolute** and **Relative** modes. Other modes, such as **Grid**: will display the **Grids** dialog where a change can be made. The active Status bar includes:

- Layer, Layer Span, Net, Style (text style, pad style, line style) also editable by clicking on Width, Size, Line Width, Side, Delta X, Delta Y, Angle and Radius (for arc)
- Units (double-click on coords when not editing/moving item), Toggle Units (mm < > thou toggle)
- Typed coordinatess (double-click on coords)
- Absolute/Relative coords (toggle)
- Current Grid
- Variants

The On-line Help System

Pulsonix provides an on-line help system with detailed information about every item within the product. You will also find help on general ‘topics’ as well as feature items.

At any time, you can press the **F1** key to access help in context of the current action, or run help from the **Help** menu and selecting **Help**.

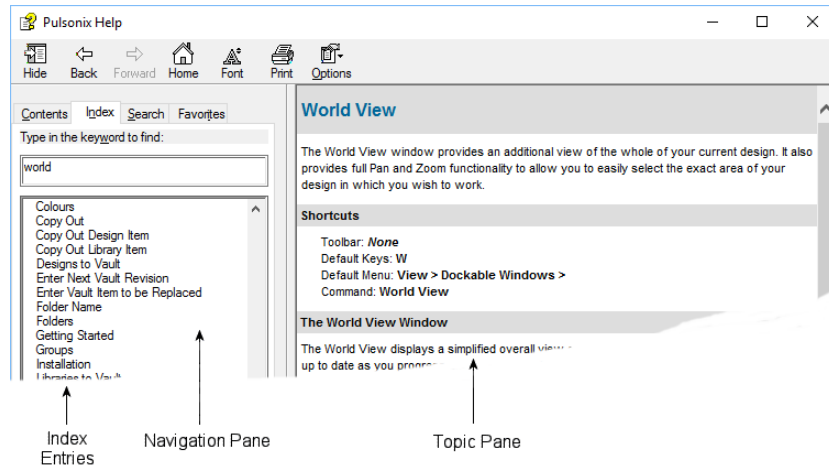

The help window is split into two main sections. The left hand navigation window displays the **Contents** list, the help **Index**, a word **Search** facility and a **Favourites** selection for retaining pages 'marked' by you. The right hand Help window provides you with the context help pages. These pages are located from one of the options on the left hand window or by using the **F1** key to obtain context help on each dialog. To view any of the topics that appear in the Index or Contents sections, double-click the mouse while over the item required. Alternatively, select the item and click the Display button.

When using the **Search** facility you can search for word strings by encapsulating the string in double quotes, e.g. "Free Angle"

Customising Pulsonix

Overview

Pulsonix provides you with the ability to customise the user interface with your own Toolbars containing option buttons that allow instant access to tools within the program. You also have a complete command set of all the options within Pulsonix which can be assigned to a shortcut key from the keyboard. Other aspects of Pulsonix can also be customised such as the application look and how the menus are revealed when you select them.

Light and Dark UI

Pulsonix can be run in Dark mode. By default, Pulsonix is installed as a new installation using the 'light' mode. If you wish to change this, use the **Tools** menu and **Customise** option, then **Application Look** tab and select the '**Dark**' radio button.

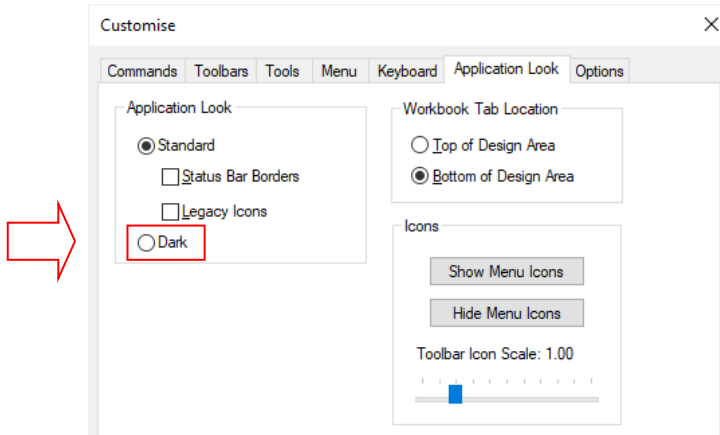

By selecting the **Dark** mode radio box and then pressing **Apply Changes** or the **Close** button, Pulsonix will then switch to using the dark interface for the application and all dialogs.

Toolbars

Toolbars in Pulsonix can be set to be both 'docked' and 'floating'. They can also be customised to contain your own choice of options and can be named for instant recognition for particular tasks, for example named **Edit Connection**, for use in Schematics that might contain connection editing and naming options.

Below is an example of a **docked** toolbar. The toolbar is docked below the Menu bar in the horizontal position. This is the default position but can be moved as required.

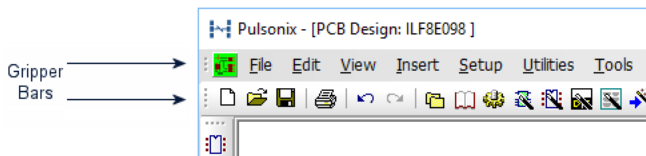

In **docked** mode, a toolbar is fixed along any of the four borders of the main window framework in either a horizontal or vertical position and will have a **Gripper** bar across the top or down the left. You cannot modify the size of a toolbar when it is docked.

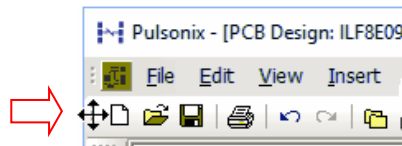

The toolbar can be moved by selecting the window border and 'dragging' it away from its current location. By dragging it, it becomes detached from the framework. When the toolbar is then moved over another area of the framework to which it can be attached, it changes shape to indicate it can be docked there. You can also make it floating by Double-clicking on the window Gripper bar or in the toolbar area itself, but avoiding the buttons that will select an option.

The toolbars can also be **floating**. This means the toolbar can be moved into free space on the design and outside the framework. This toolbar can now be reshaped to make it fatter or thinner by dragging the outer edge in or out. The toolbar can be shaped to be one tool wide or long by as many tools as are loaded on the toolbar in the opposite direction. By selecting the outer framework edges of the toolbar

a small arrow 'handle' will appear to indicate that the toolbar can now be reshaped. Drag the handle until you have the shape you require.

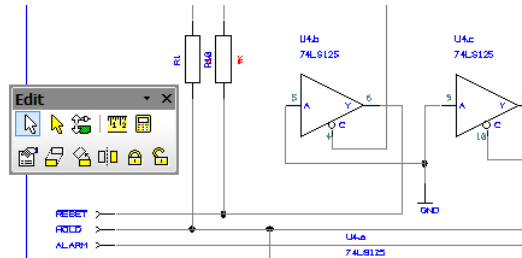

You can restore the toolbar to its last docked position by double-clicking on the name caption on the toolbar.

To move a floating toolbar, select and drag any part of the toolbar framework. The toolbar will move dynamically with the mouse movement. Release the mouse button to release the toolbar.

How to customise toolbars

Toolbars can be customised to contain the buttons (and underlying options) of your choice. Pulsonix provides a default set of toolbars that cover different design types and some design tasks, such as editing etc.

You can create toolbars for any task that appears on the menu or context menus.

To edit or create your own toolbars you must use the **Customise** option on the **Tools** menu. Once in this dialog you can move tools on existing toolbars or add/create your own. Other than in this dialog, you cannot add or remove tools from toolbars but buttons can be moved by pressing the **Alt key** and dragging the button from one toolbar to another or off the toolbar to remove it altogether.

► To create a new toolbar

1. On the **Tools** menu, click on **Customise**. Click on **Toolbars**. The Customise option is also available by clicking the right mouse button on the Pulsonix framework.

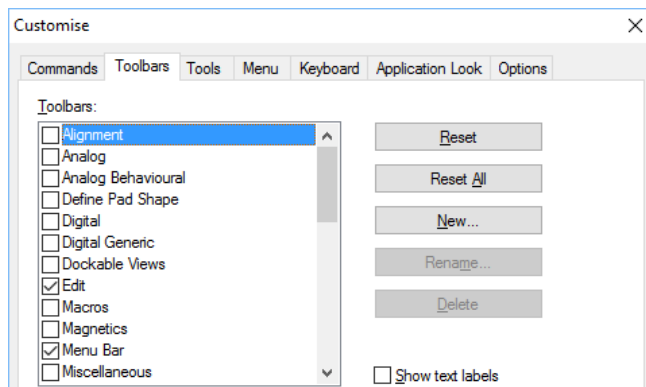

The process for adding a new toolbar and adding tools to it would be:

2. Click on the **New** button.
3. Type in the name that you wish to use for the toolbar (this is the caption name that appears as the toolbar title), and click **OK**.

This name now appears in the list of available toolbars and is, by default, already selected at the top of the toolbar list. You will also be able to see the toolbar in the design window. You will now need to add the required commands to the toolbar.

4. Click on the **Commands** tab.

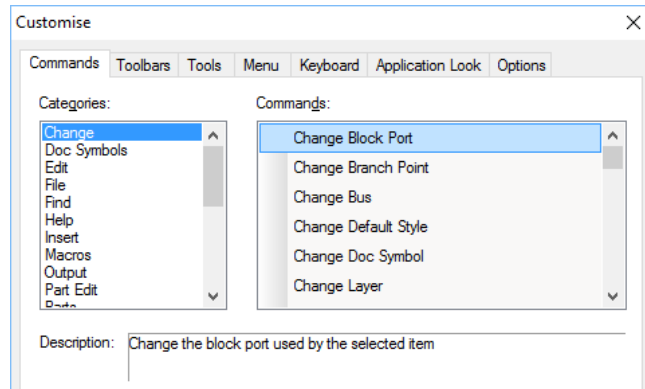

The **Categories** are arranged in the same order as the menus themselves. By clicking on each of the names in the **Categories** list you will see the buttons for the options found on those menus displayed in the **Commands** section next to it. You can also view all of the available commands by clicking on **All Commands** in the **Categories** list.

5. Click on a command from the **Commands** list.

You will see a brief description of the function of that button in the **Description:** box. These buttons can now be dragged onto a toolbar. Once the toolbar is populated with the tools you require, click the **OK** button to close the **Customise** dialog.

► To remove a button from a toolbar

1. On the **Tools** menu, click on **Customise**.
2. With the toolbar on which the tool to remove resides visible, select the tool button and drag it off the toolbar and into 'free' space. That is, space that is not part of this or any other toolbar.
3. Once complete, click on the **OK** button to make the changes permanent.

In addition to using the **Customise** option from the **Tools** menu, you can also use a more convenient method through a right mouse shortcut.

The context menu is available when the cursor is hovered over any of the toolbars, menu bar or status bar.

Commands and Shortcuts

As well as the toolbars, Pulsonix has the ability for you to programme your keyboard for commonly used options or commands. This means that once programmed, you can press a key or key combination to enter a function or option. For experienced users, this makes the program's operation far more efficient.

When Pulsonix is first installed, you will find a set of shortcuts already defined for you. These are only a default set and can be modified to your own preference through the **Shortcuts** dialog. Almost all of the keys on a standard keyboard can be utilised giving you extensive coverage of shortcuts.

► **To create a shortcut**

1. On the **Tools** menu, click on **Shortcuts**.

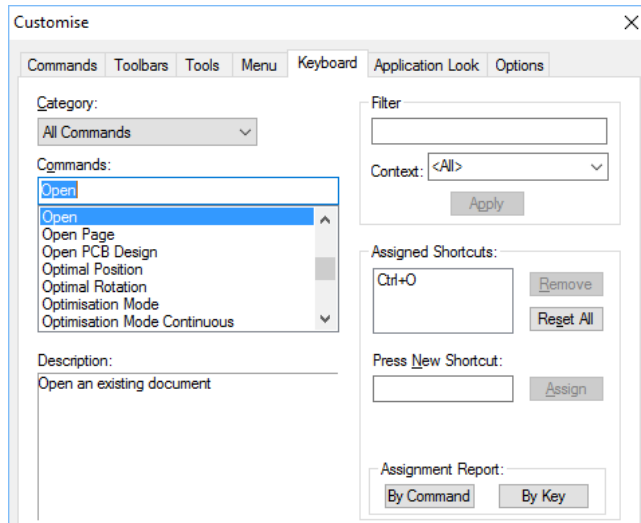

Each of the currently **Assigned Shortcuts** is displayed when the command of the same name is selected. It is possible to assign more than one shortcut to a command if required.

2. Select the option you wish to change and click the mouse in the **Press New Shortcut** window and then click the key(s) you wish to assign to it.
3. Click the **Assign** button and that key combination will be assigned to the function chosen.
4. If the key has already been used, a message will be displayed informing you that it is already assigned allowing you to overwrite it or Cancel.
5. Before any shortcut keys are assigned ready for use you must exit the Shortcuts dialog by pressing **OK**. Simply, assigning the shortcut is not enough.

A full report of all the assigned keys can be obtained from this dialog or can be run from the **Reports** option on the **Output** menu. Use the **Shortcut Keys Report** to generate the report.

Selecting a **Category** from the list of categories at the top left of the dialog causes the command list to show the commands in that category. The **<All Commands>** category shows all available commands. The **Description** box displays a brief description of what the currently selected command does. These are categorised using in-built categories and cannot be changed.

The **Find Key** and **Filter** options allow you to locate other shortcut keys.

Dockable Windows and Browsers

Overview

As part of the design suite, you have a number of dockable windows and Browsers that can be used to view specific design information. These windows are available through the **View** menu, through **Shortcut keys** and through the popup toolbar/window menu. Each individual window can be specified to **Allow Docking** (enabled through the context menu for each window or browser). This means that if not allowed, regardless of where the window is placed, it will not 'attach' itself to the

framework. If you require it to be docked, the **Allow Docking** option must be checked (with the 'tick' showing as in the example below).

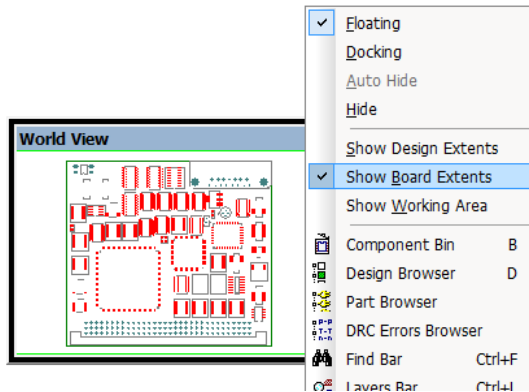

Component Bin

The Component Bin is provided to store and view unplaced components in the PCB design editor, and unused gates in the Schematic design editor.

When used in Schematics it contains unused symbol Gates not yet placed. For example, if a 4xNAND gate is loaded into the design but only one gate placed, the other three gates are placed into the Component Bin ready for subsequent use.

If used in the PCB design editor, the **Component Bin** is used to hold unplaced components. The Component Bin can be used as an integrated part of the auto place functionality. The components are automatically taken from the Component Bin and placed on the design, this can be a two way process for removal of components from the design.

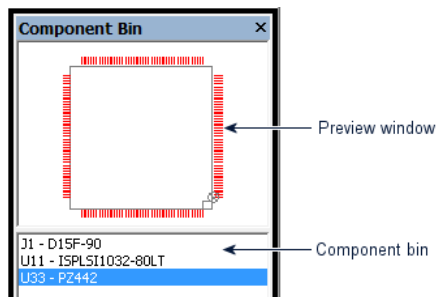

The Component Bin is a dockable toolbar. It can be left 'floating' or 'docked' on one of the sides in the design area. To move it, simply click and drag an edge of the Bin to the desired location. The Component Bin will move while being dragged, as soon as you release the mouse button it will remain in its present location until moved further.

The Component Bin contains two sets of information.

The **Component Bin Preview** window shows the Component currently selected in the bin, along with its terminal/pad numbers and names. This updates automatically as each Component within the Bin is selected.

The **Component Bin** window lists the components currently in the bin. This shows the Component reference name, the Component name and Component type and is sorted alphabetically on the Component reference name. For a schematic design and for a multi-gate Component, the gate name

and symbol name are listed for each gate of the Component. The components (or gates) are selected by clicking in this list.

Using the Component bin

Components can be placed in the Bin directly from Insert Component, from Translate to PCB or by dragging them manually into the Bin from the design. You can also select components in the design and send them to the Bin using functionality from the context menu. Any PCB Components within the Component Bin retain all connectivity but loose track information if previously routed in the design. You are warned that track information is lost before the move to the Bin can be made.

Any Schematics gates moved to the Component Bin become completely unconnected (unused).

Components within the Bin can be moved from it in a number of ways:

You can select and drag a Component from the Preview window or from the Component list. This is the most basic mode but aids fast manual placement by making the design 'clutter' free during the placement phase.

If you select **Place Around Board** and components are in the Component bin, they will be placed on the design around the board outline.

Auto place (if authorised) can move components to and from the Component Bin automatically.

Further selections in the Component bin

By right clicking in the **Component Bin** you are presented with a number of choices:

Add to Bin will open the Insert Component dialog from where you can draw components and add them directly to the Bin without exiting this option or mode.

Delete from Bin will allow you to delete individual components from the bin. This is only available in PCB if the **PCB Safe Mode** is not active in the **Options** dialog (available from the **Settings** menu). If active, you will not be able to add (Insert) or remove (Delete) items from the bin.

Empty Bin will remove any whole unused components from the bin. If any gates or Connector pins are already in use in the design they will not be removed.

Place Around Board From Bin will place selected components from the bin to around the board outline, provided one exists.

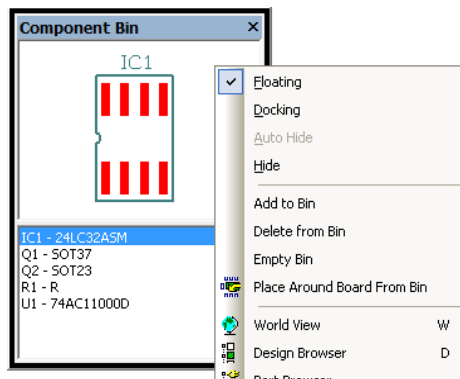

The other browsers are also available for selection on the context menu.

The Component Bin is discussed in more detail as it is used throughout this manual.

Part Browser

The Part Browser provides a convenient way to add commonly used Parts to your design.

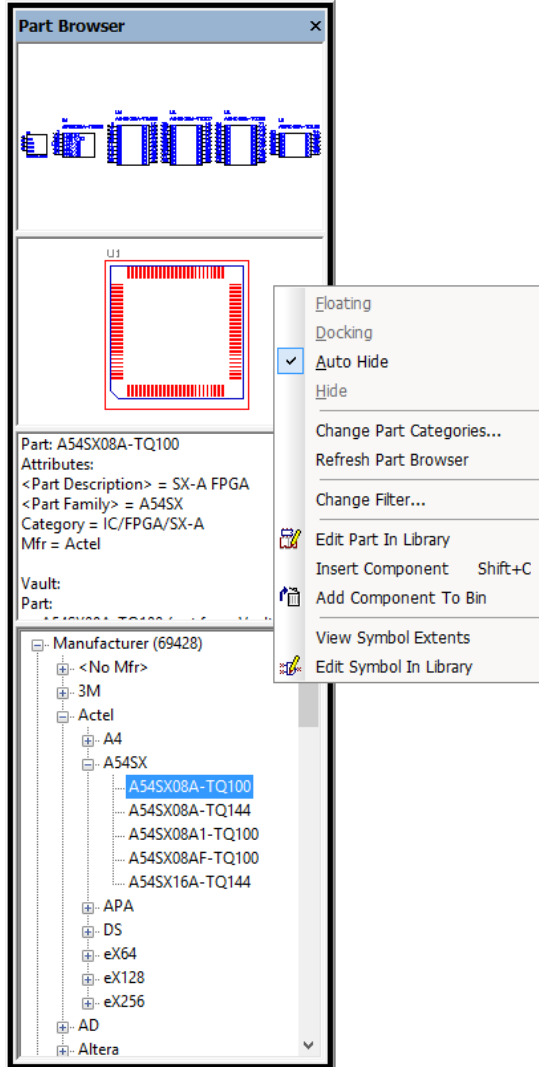

Adding components to the current design

You can add components to your design by selecting a Part in the browser and dragging it into the design, with the left mouse button held down. You will then have a Component on your cursor that you can place by releasing the mouse button. After the first Component is added, more copies of the Part are interactively added to the design until you cancel the current command, or begin a different command (including dragging another Part from the browser).

Configuring the Part browser

The browser presents a list of Parts organised according to a category attribute. The list can be hierarchical by specifying an appropriate separator character to split the attribute value into a path. You can change the attribute used and the separator character by selecting the **Change Part Categories** on the context menu in the browser.

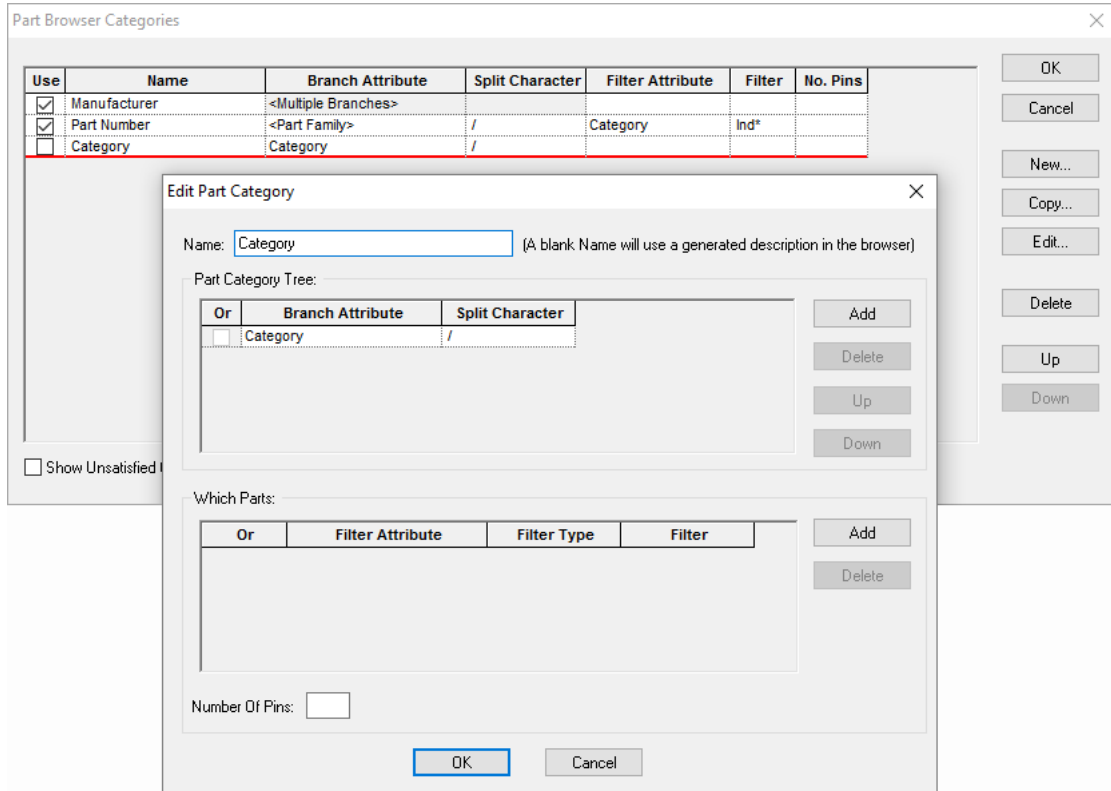

You can select more than one **Category** to list in the **Parts Browser**. This uses a grid where each row defines a category name. This also allows you to Filter the Parts using wildcards on an attribute value, or specify the required Pin Count (**No. Pins**).

Once the **OK** button on the **Part Browser Categories** dialog is clicked, the **Part Browser** will be updated with the new selection.

These attributes are the ones currently in your library indexes, to change this list you must regenerate the library indexes using the **Index** option on the **Parts Library Manager** dialog.

World-view

The world-view is a miniature view of the complete design with some detail included for coordination. This world view is used to navigate around the design, and because you can see the whole design you do not need to resize the design first.

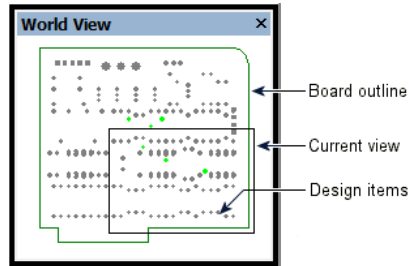

This browser can be used docked or floating (shown above as floating). Not only does it provide a view of the design but can also be used for navigating the design as well. The Zoom in/out, Pan and Home View commands are all operative in this view and are highlighted by the white **Current View** box.

Options are also available on the context menu by clicking the right mouse in the window.

By right clicking in the World View you are presented with three choices of the view to show: **Show Design Extents**, **Show Board Extents** and **Show Working Area**.

The picture below shows the World View with the view set to **Working Area**. You can see all of the design area with the design represented within it.

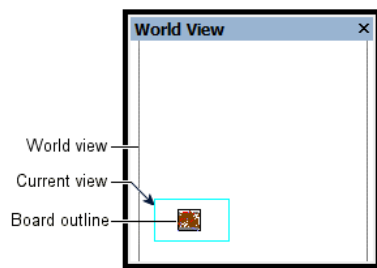

Other selections on the context menu will display the browser options also available.

Design Browser

The Design Browser is displayed as a configurable Dockable Window containing a list of all the currently open PCB and Schematic designs, technologies and profiles. For a Schematic, a tree showing all the pages in the design is shown, including any hierarchical blocks. The name of the design/page whose view is currently active in the main window is shown in bold typeface. A dimmed page icon indicates schematic pages that are not open as a view in the main design window.

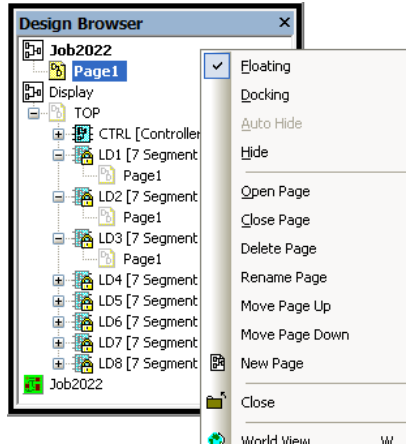

As well as being a visual guide, the **Design Browser** is fully functional and provides access to a range of design level operations via its context menu.

► To show/hide the Design Browser

1. From the **View** menu, select **Design Browser**, this will toggle the visibility of the **Design Browser** window. Alternatively a shortcut key can be defined using the **Customise** option.

Using the Design Browser

From within the Design Browser:

- Double-click on a PCB design to make that the active view within the main design window.
- Double-click on a Schematic design or one of its pages to make that the active view within the main design window.
- Double-click on an already active Schematic to hide/show its pages.
- Double-click on an unopened Schematic page to open it.
- Click on any design or page to make that the currently selected Design Browser item.
- Right click anywhere in the Design Browser window to display the context menu that provides a set of design/page level commands applicable to the currently selected item. Commands such as Close, New, Delete and Rename operations are available.

DRC and ERC Error Browsers

These browsers are used to view the design error markers that have been created by the Electrical Rules Checker, by the Design Rules Checker or by the on-line design rules checking options. The list is displayed in an 'active' browser. You can use a double click on one of the items in the list to locate the error marker in the design. This browser can be un-docked as a modeless dialog or docked as part of the Pulsonix framework. Use the right hand mouse button to make this selection.

Before using the Errors Browsers you must first run a design rules check from the **Tools** menu to find and 'mark' the errors. Errors found during the on-line DRC/ERC processes will also be displayed in this list.

The browser is categorised in hierarchical order of 'rank' starting with **Design** (number of DRC errors), then **Layer**, then **Error type**, then the **Marker** itself.

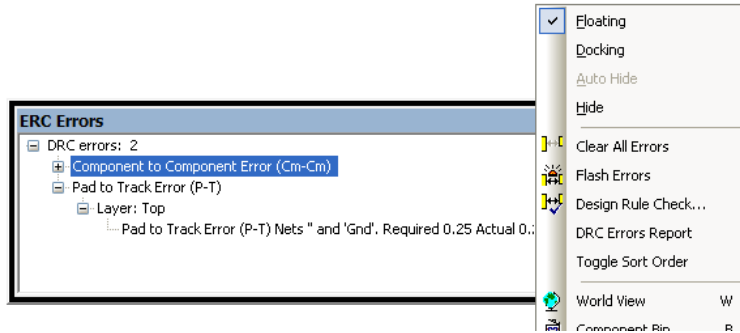

Each error marker is shown as an X,Y co-ordinate within the design. You can locate an error marker by double clicking on the co-ordinate.

An error marker is a code used to denote a spacing or design rule violation and is created by the design rules checker. Design rules errors are created when two design items violate their respective spacing or design rule. A report can also be obtained for all of the error markers in the design by using the right hand mouse context menu when in the browser.

Any error markers in the design should be cleared by running the design rules checker again. This will be an iterative process and you may need to be run the DRC option more than once or until all errors have been satisfactorily removed.

Layers

The **Layers** browser allows a fast display and switching of layers without using the **Colours** dialog. This modeless dialog is displayed as a configurable Dockable window containing a list of all the layers in the design. The checked layers are currently visible in the display window.

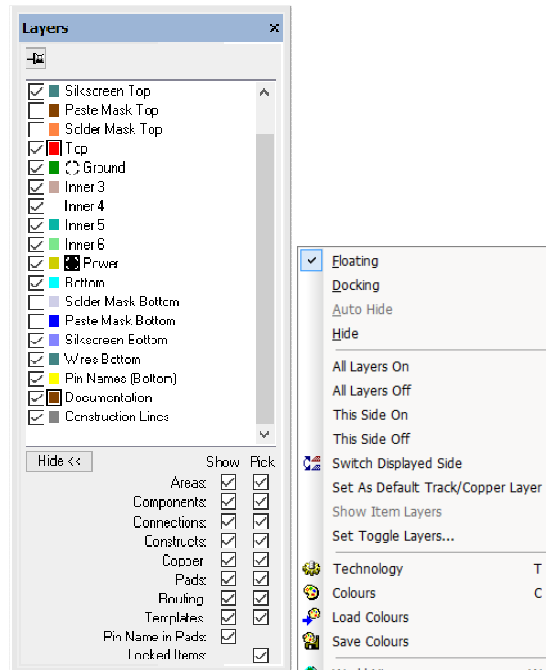

From the context menu you can also select options from the context menu. These further enhance the selection of layers and layer combinations.

Switch Displayed Side is used to switch to the set of layers for the opposite side of the board, e.g. All Top or All Bottom. This is also available as a command from the **Run Command** option on the **Edit** menu.

With an item selected in the design, the **Show Item Layer** will be displayed. You can then switch off all other layers other than that one.

Double-clicking on one layer name will switch off all other layers.

Active Layers

The colour squares within the **Layers bar** can have a black square outline around both the default electrical and documentation layers. Click on the square itself to set that layer as the default. If there is no common default (i.e. all categories do not have their default set to the same layer) the black outline is not drawn.



When starting a new track or adding a new doc shape, the default layer defined here will be used.

On the context menu within the **Layers bar**, the selections for the default layer change depending on the layer type selected (Electrical or Documentation Layers):



Showing and Hiding Powerplane Layers

Powerplane layers (Layers nominated as a Bias of Powerplane in the Technology file) are indicated by a small white thermal pad icon to the right of the layer colour square.

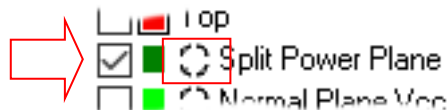

If the powerplane is being displayed (using the **View Powerplane** mode), the icon is in negative. Click on the icon to display or hide the powerplane. The icon changes to a positive format to indicate the powerplane is active.



The functions to display, regenerate and hide the powerplane are also on the **Layers bar** context menu.

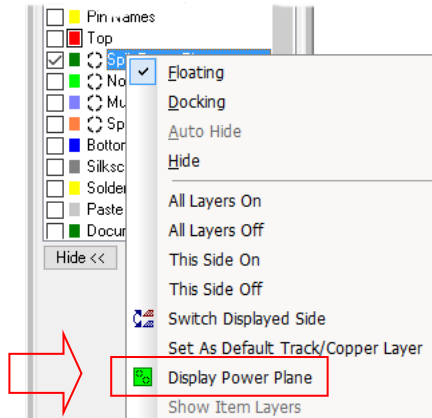

More>> and <<Hide buttons

The list at the bottom of the Layers bar contains other dockable bars that you may wish to use. If you click on one of these, it will become visible and replace the Layers On/Off bar. This allows you to use a dockable area for just 2 bars (for example) and keep replacing them with the next bar you wish to use.

Find

The **Find** *item* browser is available as a dockable bar. Using the shortcut key <Ctrl-F>, you can find and select design items using the drop down list box.

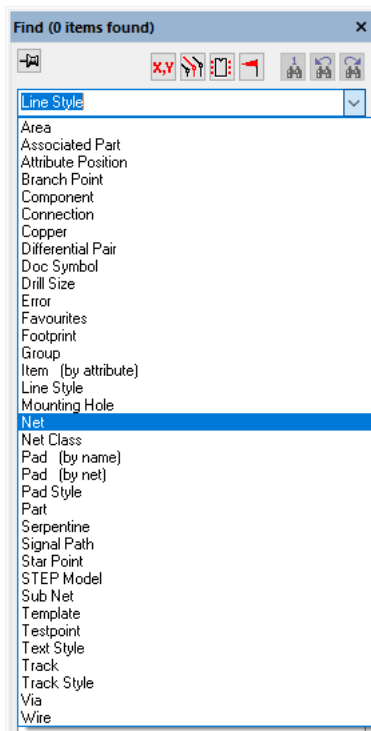

The dialog presents you with a list of items from which to choose.

The list will show named items of the selected type in the design. In the example above, components are shown. If the item type does not have names (e.g. Copper) then a list of nets containing items of the chosen type will be shown. If the item type is **Errors**, a list of the possible error codes is shown. If the item type is **Attribute**, a list of the used attribute names is shown (see below).

Click on a named item to find it in the design. It will be highlighted (or optionally selected) and optionally centred in the display window. If the list contains a list of nets, click on the required net or use <Search entire design>. The first item of the required type on the chosen net (or entire design) will be found.

On the browser bar are two additional sets of icons. The set on the left side are permanent and are used to find components, Nets and X,Y positions. The second set on the right side is item sensitive and are not enabled for every item type.

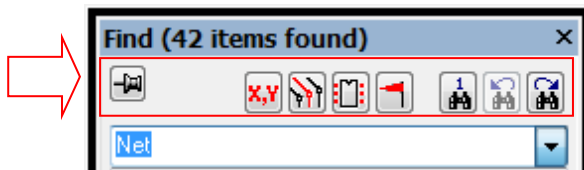

The 'pin' icon on the left hand side is for 'latching' this browser if 'floating' and is discussed below. The three other icons are for **Finding the First item** in the list, **Finding for Next item** and **Finding for Previous item**.

Once items have been found (using any conditions from the **Filter** options, if filtering), the **Find First** will then start the search on the first item. **Next** and **Previous** will toggle through the list of found items if there is more than one item found.

The Find context menu

From the **Find Browser** you also have options available on the context menu to find and display found items.

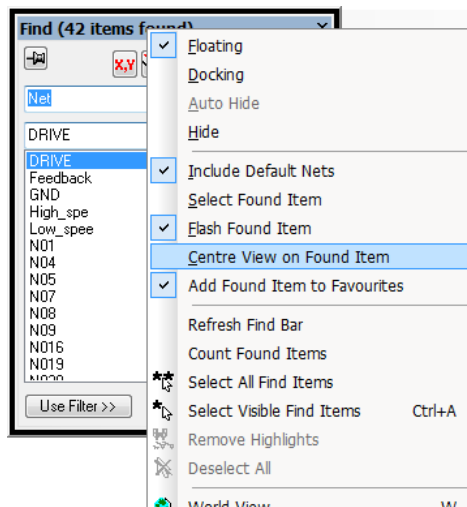

The flashing of items is controlled by the **Options** dialog and **Find** page.

The screenshot shows the Options dialog with several sections:

- Action On Found Item:**
 - Select It
 - Highlight It
 - Brighten It (Dim all other items)
 - Flash It
 - Centre View On It
 - Allow Find Under Sliding Bar
 - Add To Favourites List
- Flashing Items:**
 - Flash For: seconds
- Finding Nets:**
 - Include Default Nets
- Finding Error Markers:**
 - Include Locked Errors
 - Only List Errors In The Design
- Finding Drill Size:**
 - Use Drill Table Units
- Finding Components:**
 - Allow Drag to Fetch Component
- Schematics Search:**
 - All Pages
 - Open Pages
 - Current Page
- Favourites List:**
 - Maximum Items In List:
 - Dim items in colour
 - Dim Bright
- Variants:**
 - Search In All Variants

The Item Filter in Browser Windows

Some of the browser windows have a **Filter** mechanism so that item searches can be made on specified criteria.

To use this option, click on the **Use Filter** or **Change Filter** button if you want to further define the search criteria and reduce the number of items to find. If the button has the text **Change Filter**, then a filter is currently being applied to the list. When the button is selected a set of extra filter controls will appear to use, these are detailed below. When the **Hide Filter** button is selected, these filter controls will disappear.

Check the **Filter Names** checkbox to enable the name filter control. If the Find list contains a list of named items (e.g. components) or net names, type the filter string containing wildcard characters '*' and '?' into the control underneath the **Filter Names** checkbox. Use the drop down list to obtain filter strings previously used for this item type. When the filter string has been changed the **Apply** button will be enabled. Press **Apply** to apply the filter string to the list of names.

The screenshot shows the Item Filter dialog with the following controls:

-
-
- Filter Names
 -
- Attribute:
 - <Component Height>
- Is:
 -

Further filtering of items can be done using an attribute condition. Check the **Attribute:** checkbox to enable the attribute condition controls. Use the dropdown list underneath the **Attribute** checkbox to

choose the attribute name you wish to use. Next use the **Is** dropdown list to select the type of test to apply to the attribute value. Then, in the remaining edit box, type in a string representing the condition to test against.

Press **Apply** to reduce the items to be found to items that satisfy the attribute condition. The attribute filter applies to unnamed items as well as named items.

The 'pin' status of Dockable bars

The pin on some Dockable bars is used to show whether the dialog is latched or not. In an unlatched status (shown in the picture below but only applicable if 'floating') once an item is selected from the list, the dialog dismisses itself. If the pin is latched, the dialog is persistent and always displayed until closed by you.



Selection Mask Window

The **Selection Mask** toolbar allows you to choose design items that are selectable within the design and save the mask for subsequent reuse.

This option is available from the **View** menu and from the custom menu enabled by right clicking on any of the Pulsonix framework (enabled the same way as the **Design Browser**, **Part Browser**, **World View** etc.). It can also be enabled by right clicking on any of the existing open Browser windows and selecting it from the context menu.

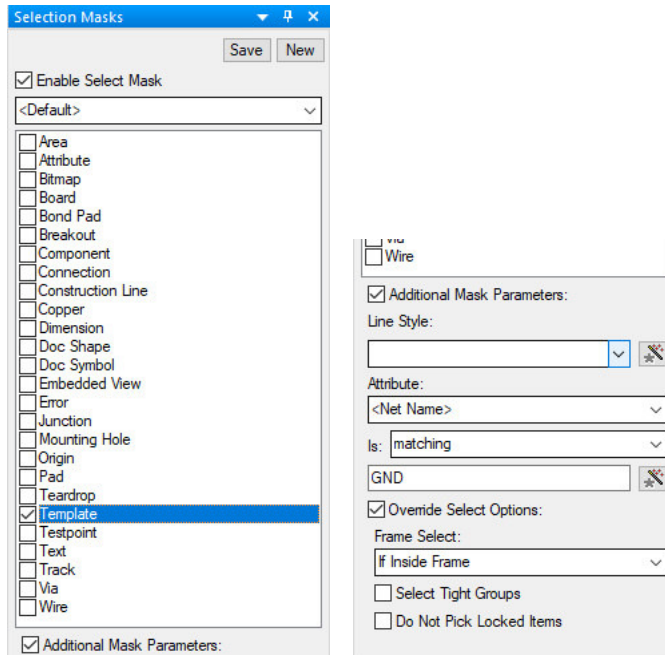

Using the browser dialog

You can use the Selection Mask on a task by task basis or you may prefer to create a selection mask and save it for subsequent use.

You can create a list of selection masks that can be defined and saved. You might create a number of selection masks for all Track and Pads for example.

To activate the Selection Mask and start to use it, select the **Enable Select Masking** check box. Without this selected, nothing happens. Initially, the <Default> selection mask is shown. This is the selection of check boxes in the list as currently set. If you change the selections and press the **Save** button, this then becomes the new <Default> selection. However, you may wish to be more specific about your choices and to reuse them.

You can save multiple named selections by pressing the **New** button. When this button is pressed, the **Create New Selection Mask** dialog is displayed. When the **Create** button is pressed, the selection mask is saved. Using the **Copy Current Selection Mask** will enable you to make the selections, then save them. You could also use this to make slight modifications to an existing selection mask and save it to another named selection.

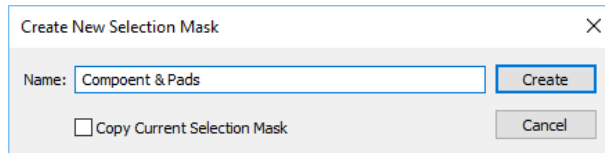

The drop down list on the Selection Mask dialog displays all previously saved Selection Masks

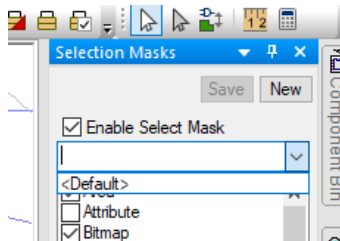

Check box options on the Selection Mask Dialog

There are additional filters to enable refinement of the selection. With **Pads** selected, selecting the **Additional Mask Parameters** enables the Pad Style drop down list from where you can choose a pad style. This can a specific pad style or can be a wildcard name. The Wildcard wizard helps you create the name.

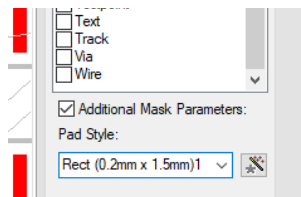

With a Pad style selected, you can then only choose pads that match that style.

Inspector Bar (Dynamic Properties)

The **Inspector Bar** acts as a dynamic **Properties** windows, however, it is different.

Accessed by right clicking on the Pulsonix framework and selecting **Inspector** off the list of bars available, or access it from the **View** menu and selecting **Inspector Bar**. Generally speaking, the Inspector Bar would be left either docked open or floating so that it is accessible instantly.

With an item selected, the Inspector Bar will display **Properties** for that item, for example, a selected Component in PCB:

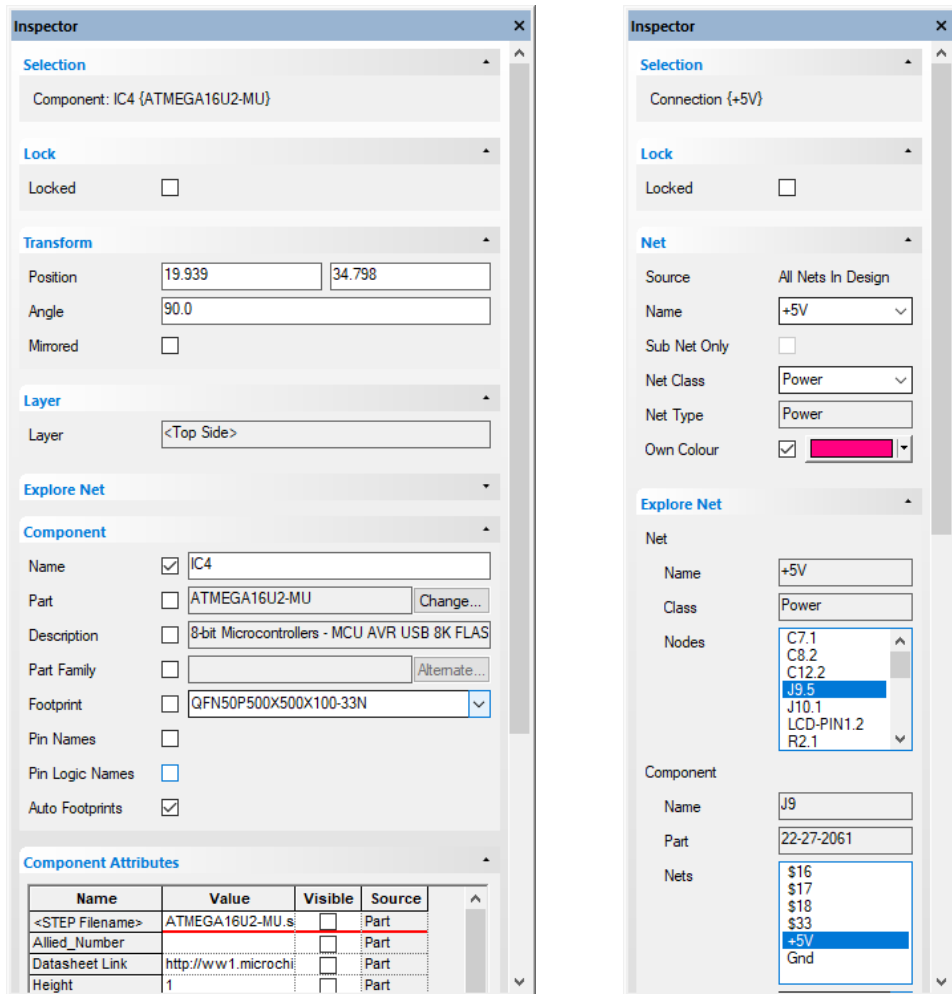

Context Menu Options

By right clicking on the Inspector Bar, you can access additional commands:

Change Group Order

Select **Change Group Order** to rearrange the ordering of the 'groups' or sets of properties displayed in the Inspector Bar.

Use the **Up** and **Down** arrows to move the selected group up or down in the Inspector Bar list.

Groups can be shown or hidden in the Inspector Bar using the check boxes next to the group or by using **Show All/Hide All**.

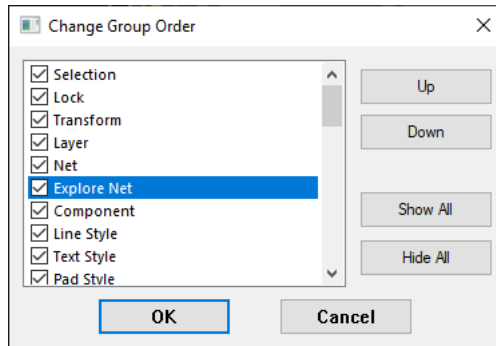

Explore Net

The group **Explore Net** enables you to see the nodes on a selected net and the nets on the component (if the node is from a component). This functionality also works in reverse, so for a selected component, the Inspector Bar will show all nets on that component.

Selecting a node or net from one of the lists in the group will update the other list (Net or Component or vice-versa), allowing the connected nets and nodes to be traversed (or explored).

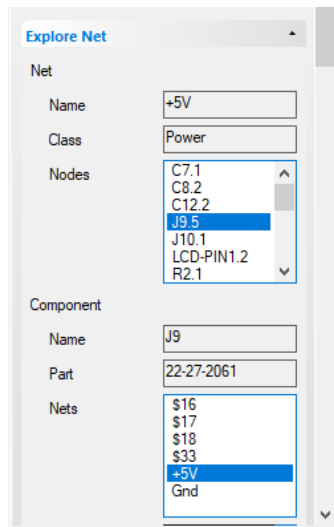

Single Clicking to Navigate Nets & Nodes

Single click will 'navigate' net and nodes, using a double click will highlight net.

Find Options

This offers the same finder functionality as the **Find Bar**, with the Find Bar options being used here as well. These options can be viewed and changed from the Inspector Bar by right-clicking anywhere on the bar and hovering over the **Find Options** context menu.

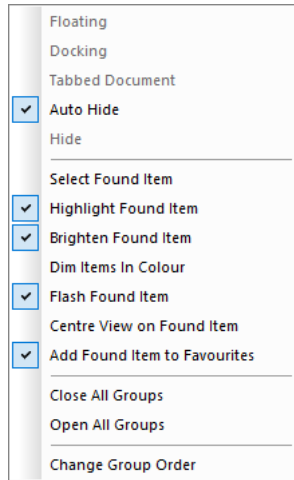

Other Browser Bars Available

Other browser bars are available but are only briefly described here:

Shape Information/Editing Bar

The **Shape Information Bar** appears as a dockable window accessible from the **View** menu and by right clicking on the Pulsonix framework. This displays detailed information about the currently selected shape in a grid format that also updates on the fly. It is available to use when editing PCB and Schematic designs, Symbols and Technology files. The text in the grid describes the shape details that may be edited allowing precise modifications to be made.

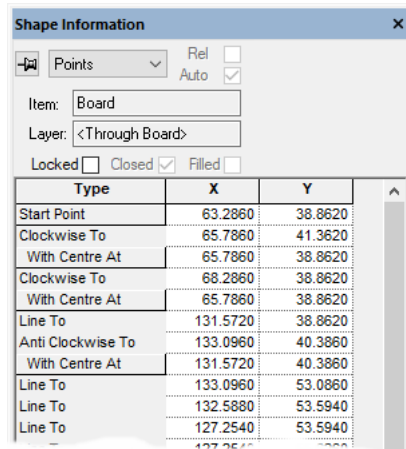

Toggle Layers Bar

The dockable **Toggle Layers Bar** allows you to activate any of your defined layer toggles on the fly, while in design. This is available from the **View** menu and by right clicking on the Pulsonix framework.

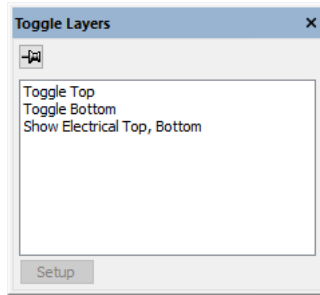

The **Setup** button will take you to the **Setup Toggle Layers** dialog from where you can define the Toggle Layers.

Colours Files Bar

This browser is used for displaying and selection of Colour files that you have saved previously. By selecting a file name, the colour settings within that file will be quickly applied to you design.

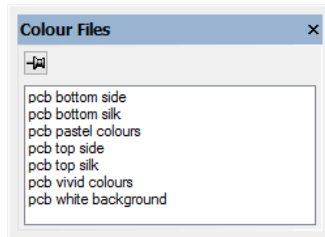

Attribute Editor

The Attribute Editor option presents all the attributes currently in a design (or library) using a 'spreadsheet style' table, this is available as **Attributes...** from the **Edit** menu, or the **Attributes** button on the **Libraries** dialog.

Attributes of: Components
Value = 100uF

Name	Part Name	Family	Footprint	Value	Category
AC	22-27-2021	CONN/22-27-2	MOLEX 22-27-20		Connector/Header
BELL	22-27-2021	CONN/22-27-2	MOLEX 22-27-20		Connector/Header
C1	SR305C105KAA	C/SR30	SR30	100uF	
C2	SR301C105KAA	C/SR30	SR30	1uF	
C3	SR212A220KAR	C/SR21	SR21	22pF	
C4	SR212A220KAR	C/SR21	SR21	22pF	
C5	489D106X0010C1	C/489D-C	BEAD 0.6mm	10pF	Capacitor/Radial Le
C6	SR215A103KAR	C/SR21	SR21	10000pF	
C7	489D106X0010C1	C/489D-C	BEAD 0.6mm	10pF	Capacitor/Radial Le
C8	SR215A103KAR	C/SR21	SR21	10000pF	
C9	T351A105M020AS	C/T351	T351	1uF	
C10	T351A105M020AS	C/T351	T351	1uF	
C11	T351A105M020AS	C/T351	T351	1uF	
C12	T351A105M020AS	C/T351	T351	1uF	
C13	489D106X0010C1	C/489D-C	BEAD 0.6mm	10pF	Capacitor/Radial Le
C14	489D106X0010C1	C/489D-C	BEAD 0.6mm	10pF	Capacitor/Radial Le
C15	SR301C105KAA	C/SR30	SR30	1uF	
C16	SR301C105KAA	C/SR30	SR30	1uF	
D1	L-7104SRD-J4	Diode/LED	LED1-1	RED	
D2	L-7104SRD-J4	Diode/LED	LED1-1	RED	
D3	1N4004	DIOD05			Diode
J2	22-27-2021	CONN/22-27-2	MOLEX 22-27-20		Connector/Header
J3	1WP	HDR1			Connector/Header
J4	1WP	HDR1			Connector/Header
J5	22-27-2061	CONN/22-27-2	MOLEX 22-27-20		Connector/Header
J6	22-27-2031	CONN/22-27-2	MOLEX 22-27-20		Connector/Header
J7	22-27-2031	CONN/22-27-2	MOLEX 22-27-20		Connector/Header
J8	DF9NM	GenericD-Type	DF905SKcut		Connector/Generic

Buttons: OK, Apply, Cancel, Add Attrib..., Rename..., Delete Name, Edit..., Delete, Copy Tags, Copy, Paste, Revert, Show, Hide, Colours..., Columns, Save, Visibility..., Show Empty, CSV Tags, CSV Hidden, Export CSV..., Import CSV...

You can use this editor to not only view all the attributes and values in use but also to manage attributes such as adding, removing and editing them.

Attributes for different design items can be designated using the **Attributes of:** drop down list. The types of items available will depend on the type of design or library from where you have invoked this dialog.

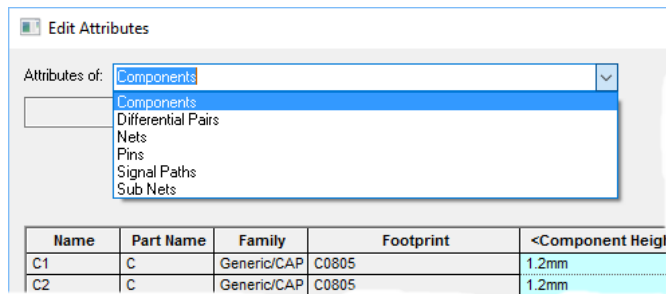

If an attribute has already been assigned to an item (along with a value), other items can also have a value assigned to them by simply editing the appropriate cell. Editing attribute values can be done directly in the grid, just like working with a spreadsheet. They can also be modified using the function buttons provided.

Cells in the grid are coloured depending on their 'state', indicating for example whether a particular item has the attribute defined but empty, or defined but hidden, or defined and visible.

The order in which items are displayed in the dialog can also be changed. Right-clicking on the column heading will display a context menu from which to **Sort the Column**. You can also use this to edit the name or add a new name (attribute) column heading.

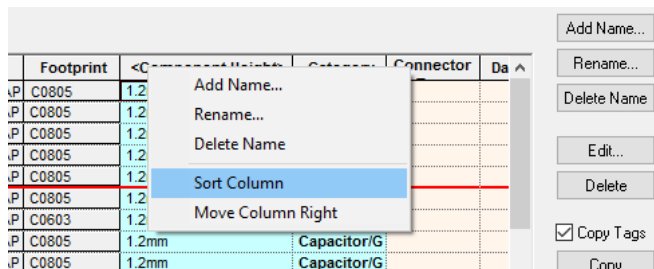

The columns are initially sorted alphabetically looking from left to right but the order can be modified to be user definable. Again, using the context menu, use the **Move Column Right** option. You also have the ability to **Show and Hide Columns** and to control their visibility using **Column Visible** button.

As well as entering values directly, you can also **Copy** and **Paste** values between cells (or ranges of cells) in the grid or from an external source such as an Excel spreadsheet. Ranges can be copied and pasted using the buttons or by using standard Windows commands, **Ctrl-C**, **Ctrl-V** for Copy and Paste respectively.

Use the **Revert** button if you have accidentally modified the wrong cells but don't want to cancel the whole dialog. Pressing Revert will return the selected cells to their original values, leaving other cells untouched. This button will only be enabled if one or more of the selected cells have been modified.

Mouse Operation

The mouse is used extensively throughout the use of Pulsonix, not only for menu and option selection but also for interaction within the design.

The standard left and right mouse buttons provide selection and context menu functionality respectively (these can be reversed using the mouse controls built into the **Control Panel**).

Before using the 3-button wheel mouse, you may need to install a mouse driver that enables the wheel to be used. Use the **Control Panel** and **Mouse** control to setup and enable the mouse driver. Consult the manual that accompanies the mouse and driver if you are unsure about setup details.

As well as the shortcut keys, Pulsonix has been equipped with the **Pan** and **Zoom** functions on the mouse wheel and wheel button, (e.g. available on the Microsoft® Intellimouse). This feature is only available when the wheel mouse is enabled using its own software, and if the wheel mouse pointing device is attached.

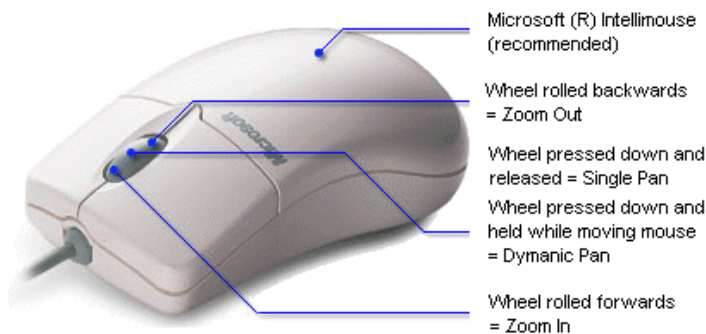

When the **wheel** is **pressed** down and released, a single **Pan** is performed centralising the design to cursor position, (the same as the <P> key). Keeping the wheel button pressed down will enable panning of the design until released.

When the **wheel** is **rolled forwards** (without being pressed) a **Zoom In** is performed to the current cursor position (the same as the <Z> key). If the **wheel** is **rolled backwards** (again, without being pressed), a **Zoom Out** is performed to the current cursor position, (the same as the <U> key).

3D STEP Preview

When using the **3D STEP Preview** option in Pulsonix, you can also use the 3DConnexion SpaceMouse. This should be installed using the appropriate mouse driver. Pulsonix will support the mouse buttons in 3D mode.

A special note too about mouse operation within the 3D Preview – the right mouse button press requires the Ctrl key to also be pressed to enable a view rotation of the whole design.

Viewing the Design

With the advanced graphics of Pulsonix there are a number of methods of moving around the design and zooming in and out. You can use menu commands, Shortcut keys, the World View, and the Mouse Wheel button to achieve the same results.

As discussed previously, the World View can be used to quickly locate known items or areas within the design. In normal design practice, the Zoom options will be required more often than not to get into detail of the design rather than into new locations of the design.

For this discussion we have concentrated on the primary objectives; zooming in and out quickly on the design using the most accessible methods.

The Zoom and Pan shortcuts

To zoom in and out using the default shortcut keys press <Z> for **Zoom In At Cursor** and <U> for **Zoom Out At Cursor**. These keys will zoom in and out respectively to the current cursor position.

To **zoom** to the design **extents (Zoom Extents)**, including the board outline and components (and also including any other design information such as page border etc.) use the <A> key.

To **Frame** into a design area use the <F> key, click and drag an area around the items required.

The **Pan** function is available on the <P> key or the middle mouse wheel button. The screen will pan and centre to the current cursor position, and keep panning if the <P> key remains pressed

View selection allows you to select an item(s) and view just these in the design window without having to accurately frame the window around them.

You also have the **View Board** and **View Actual Size** options. **View Board** is similar to **View All** but it allows you to frame into just the board outline area regardless of any other design items outside these extents, for example a page border would not be included in the view unless inside the board outline! There is no shortcut key assigned by default to this option. **View Actual Size** will enable you to visualise your PCB designs at a scale of 1:1 if this option is selected. You may need to calibrate your screen before using this. Do this from the **Options** dialog, **Display** page and **Calibrate Actual Screen Width**. Details about performing this can be found in the online help.

View All can be used to view all of the design, this includes all drawing borders and text outside the actual board outline. Useful for viewing everything in a Schematic design as well.

Design Item Selection

Select Mode

There are a number of ways that items in Pulsonix can be picked and selected.

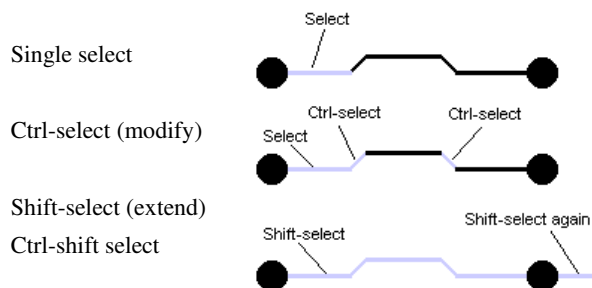

The diagram above shows the different modes of selection. The lighter grey shows the selected segment.

Single Select

A single click of the mouse will make a single **selection** of any item. By selecting another item, the first selected item will be deselected. Note that the item may be part of a larger entity, e.g. a single segment of a track. If you wish to have more than one item selected use the extended select option (see below). Once a selection has been made, a process or option can be performed on it.

Mouse Drag

A single click of the mouse followed by a move of the mouse but keeping the mouse button pressed down will enable a 'drag' to be performed. This is often referred to as click and drag. In Pulsonix, this will perform a **Move** on an item, or with nothing under the cursor or within the picking tolerance, will perform a frame selection.

If the **Ctrl** key is pressed before drag, the item being moved will also be duplicated, in this instance a new copy of the item will then be moved.

Control (Ctrl) Select

Using the **Control (Ctrl)** key while making a selection will modify the selected status of the current item. This means multiple items can be selected whether they are associated with items already selected or not. Using the Ctrl key will toggle the item to be selected or deselected.

Extended (Shift) Select

Use **Shift** select to increment the selection to the whole entity. This could be the complete net on any single page in Schematics, or the complete connection/track for all visible tracks on the net in PCB, or Component if a pad has been selected. By keeping the Shift key pressed and selecting the item again, the selection is further increased. This can be shown on a track that spans more than one device. The complete 'net' for the track would be selected.

Some examples worthy of note for extended (shift) selection are; for any completely selected cutout using Shift will select the whole shape, and for a completely selected copper shape associated with a template using Shift will select all copper shapes on the template.

Ctrl-Shift Select

The **Ctrl** and **Shift** keys together add to the selection and increase the selection to the complete item. You might use this if attempting to select two track paths for tracks on different nets.

Path Select

An option on the context menu in **select** mode allows you to select all segments in a shape or a track path between two selected points. If the selected points are in the middle of segments, they are split.

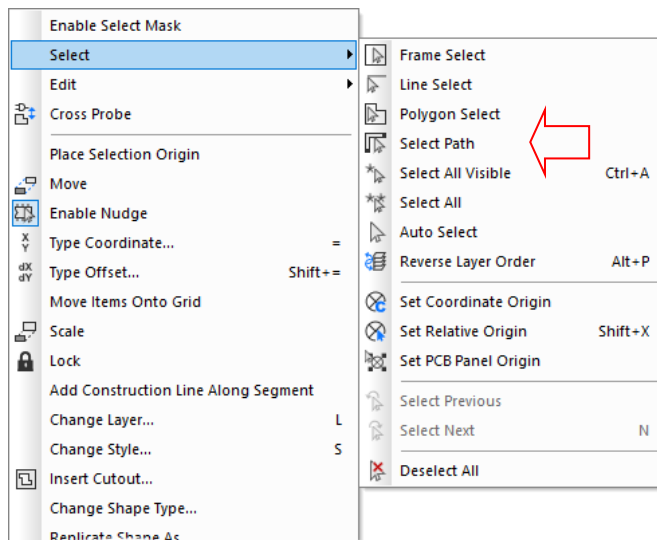

The path select mode can also be accessed by simply dragging along the line or track segment (provided you have this mode enabled in the **Options** dialog on **Select** page under **Drag**).

The process for inserting segments is to drag along a segment which selects part of the segment, and then drag the selected segment to create a ‘top hat’ shape as shown below.



If you wish to select more of the shape, then simply drag further along the shape. Once the drag has been initiated and the shape segment picked up, the mouse movement will mimic the shape of the segment without having to follow it accurately.

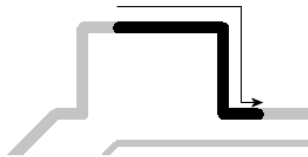

If you don't want to drag to select the path, the **Select Path** option can also be used from the context menu.

Possible usage

Uses of this could include:

- Dragging segments in a track or line shape to insert a ‘top hat’
- Unrouting a track between two points
- Necking between two points (using the Select Path command followed by <S> Style to change the segment thickness)
- Changes layer between two points

Frame and Polygon Select

Frame and Polygon Select are used to make selections based on areas drawn using the mouse. The difference between the two modes is that **Frame Select** allows you to draw a rectangular frame around items, whereas **Polygon Select** allows you to draw any shape to make the selection.

During **Frame/Polygon Select** you can also use the **shift** key to select extended items.

Frame Select is used by clicking and dragging the mouse around the objects required within the area. This is the default mode but if you wish to use Polygon Select, right click in free space and pick the **Polygon Select** option from the context menu.

Both **Frame Select** and **Polygon Select** modes will act on individual track segments to facilitate segment picking. These operate with the check box in **Options, Select** page, **Select if Completely Framed** set to on or off.

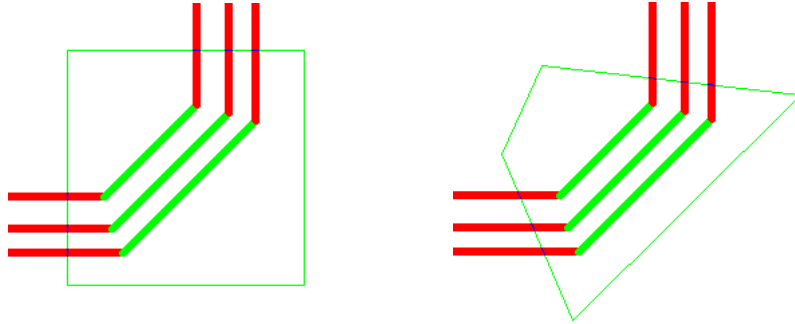

Line Select

With nothing selected in the design, right click and the new **Line Select** selection mechanism will be available, if something is already selected it will be on the Select sub folder. Use this to define a straight line to select only items that cross that line.

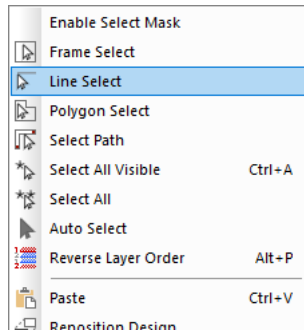

Once selected from the menu, draw the line across the items you wish to select.

The selection will then be made:

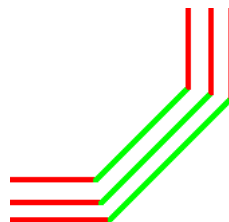
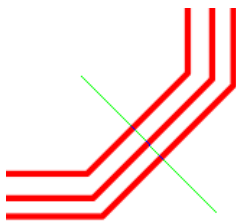

Like **Frame Select**, keep the **Ctrl** key pressed down to alter the selection. Use the **Shift** key to extend the selection to whole items.

Line Select is also available from the context menu in **Align** mode and **Latched** operations such as Move when nothing is initially selected.

Double-click Editing

By using double-click on an item you will automatically enter the edit mode. On Schematic connections and PCB track items this means the segment **selected** will be edited so that its path can be changed. On PCB connections the connection will be converted to a copper track ready to have the path created. This editing mode can also be used for all other shape based items or line editing.

For all other design items the **Properties** dialog for the selected item will automatically be displayed, allowing you to make edits based on the contents of the dialog.

Auto-select Mode

Pulsonix has an active architecture, with the database capable of extremely fast selection. To utilise this fast selection, you have an Auto-select mode of operation available. Auto-select allows you to move the cursor over items within the design and obtain instant selection without clicking the left mouse first. Clicking the mouse key now performs the 'Edit' function on the selected item.

Cyclic picking

When attempting to select items within a dense area of the design, it is not always easy to pick the item required at the first attempt. Under these circumstances Pulsonix has a system of picking that 'cycles' through items in close proximity to aid the selection. This allows you to make a selection, then toggle through the design items adjacent to it until you select the item required.

The keys used for the commands **Select Next** and **Select Previous** can be user defined but by default the **Next** command is set to <N>, the **Previous** command is not set by default.

Select from popup list

Holding down the **Alt** key and **selecting overlapping items**, a context menu will list all items at that position, allowing you to select a specific item based on its description rather than the item. This is an alternative to selecting the first item, then pressing the <N> key to get the new selected item within the picking tolerance.

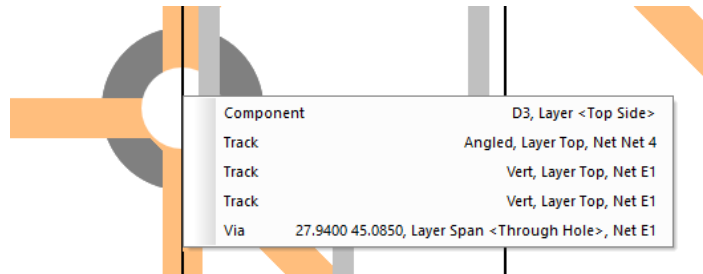

This feature can be disabled in the **Select** section of the **Options** dialog and **Select** page.

Configurable selection flags

In addition to the ability to select the next and previous items in the design using cyclic picking, Pulsonix also contains a mechanism for enabling and disabling design items. This mechanism is located on the **Colours** dialog alongside the **Displayed** selection.

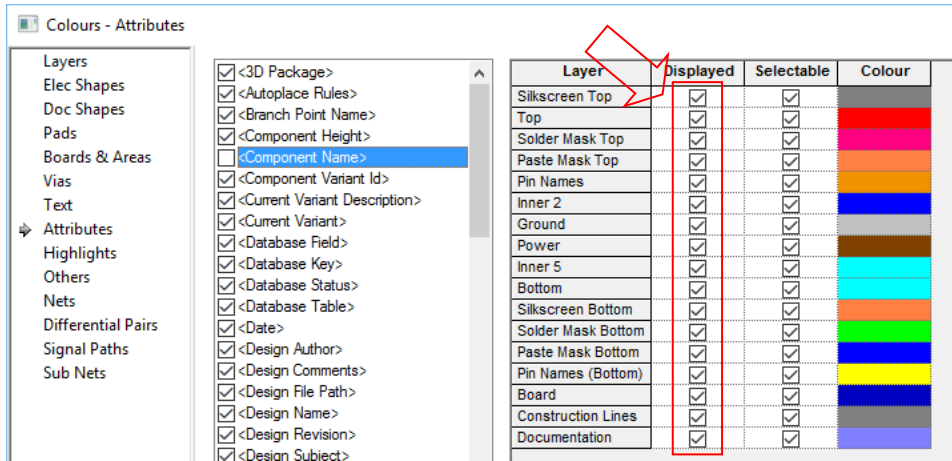

By making a selection in the relevant check box, you can make individual design items selectable or not.

'Latch' Mode

Latch mode is a mode of operation that allows a tool to be pre-selected (latched) and applied to many items until it is toggled off (unlatched). For example, the **Rotate** mode can be latched down and rotations applied to many components in the design in turn.

To exit latch mode, you can either select the option again to unlatch it, or press the <Esc> key on the keyboard to return to **Select** mode. You can also use the **Cancel** option from the context menu after right clicking the mouse.

Context menus

The right mouse button can be used extensively throughout Pulsonix to reveal **context menus**, these are also known as **shortcut menus** or **pop-up menus**. These menus can be accessed during an operation or by direct selection using a 'right mouse click', each menu has a set of relevant commands in 'context' for that option.

Once familiar with the system, you can access the context menus by right clicking on an item rather than left mouse clicking to select and then right mouse clicking. By right clicking directly, you can select the item and display the appropriate context menu.

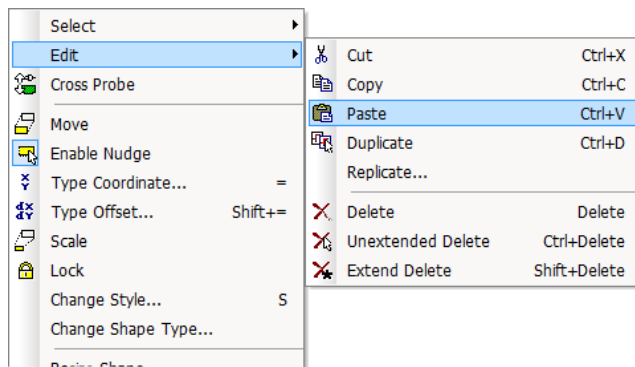

The example above shows the contents of a typical context menu, this one from the pin item in a Schematic design. Once displayed, the context menu will remain on the screen until an option from it is selected or the <Esc> key pressed. The menu options are selected using the left or right mouse button.

The Design Settings Dialog

Design-based options are defined on the **Setup** menu in **Technology** and **Design Settings** dialog. These are created for and saved with each individual design, they would also be saved to the Technology.

The image shows a screenshot of the Design Settings dialog box, which is organized into several sections:

- All Text:** Contains checkboxes for "Adjust To Readable Orientation" and "Multi-Line Text Vertical Align". It also has a "Barring Character: (when doubled)" field with a small input box containing an underscore.
- System Font:** Contains a checkbox for "Proportional Width Digits".
- CAM/Plot:** Contains a checkbox for "Transform about design extents".
- STEP Model Alignment:** Contains a "Snap by:" section with radio buttons for "Centre" (selected) and "Origin". It also has a checked checkbox for "Use Adjustment Attributes".
- Attributes:** Contains a "Substitution Char: (when doubled)" field with a small input box containing a percent sign.
- Matching Styles:** Contains radio buttons for "By Name Only", "By Name And Value" (selected), and "By Value Only".
- Naming Rules:** Contains a checkbox for "Make named styles use naming rules".
- Pad Exceptions:** Contains checkboxes for "Mirror with Component" and "Move with Buried Components".
- Net Optimise:** Contains a checkbox for "Pads/Vias connect by centre".
- Spacing Rules:** Contains a checkbox for "Enable linking of types".

The Options Dialog

Much of the main option customisation is done through the **Options** dialog on the **Tools** menu with some set-up through the **Folders** option. These are generally options on the tools themselves, such as being able to set the editing angle of the lines etc.

There are subtle differences between the Schematic and PCB **Options** dialogs but these relate mainly to the Track/Connection editing functionality and general PCB functionality, such as **On-line Design Rules Checking** and **Move** (because of **Component Pushing** etc.).

The screenshot shows the 'Options' dialog box with the 'General' tab selected. The settings are organized into several sections:

- Relative Coordinates:** Show relative coordinates in dialogs when used
- Default Units:** Imperial Metric
- Cursors:**
 - Style: Standard (dropdown)
 - Use Modal Cursors
 - Snap Cursor to Grid
- Screen Print:** Always Print in Black
- Environment Variables:** Substitute Character: %
- Importing from Other Systems:**
 - Show Design Browser
 - Default to No Technology
- API:** Upon encountering an error: Show application Ignore and continue
- Allegro Extract File Path:** [Text field] [Browse...]
- Multi-Threading:**
 - Enable Threads
 - Thread Count: 8 (slider)
- Undo:** Number Of Levels: 10 (spinner)
- Help:** Always On Top
- Libraries:**
 - Floating Manager
 - Close Dialog On Edit
- Recent Files on File Menu:** 9 entries (spinner) (Note : Needs program restart to take effect)
- Dialog Grids:** Edit on Double-Click only
- Open as View Only:**
 - Open Schematic designs view only
 - Open PCB designs view only
 - Ask at program startup
- Vault:** Switch Vault Functionality Off
- UTF-8:** Suppress UTF-8 BOM

The tabs are set out so that they are grouped by logical areas of functionality. The **General** tab (shown above) is used to set Pulsonix system type information for example.

More detailed information relating to setting up preferences through the **Options** dialog will be discussed in each section of the manual relating to particular features.

The Properties Dialog

Each **item** in the design contains a set of characteristics that can be viewed or edited using the **Properties** option. Some items within the design are made up of several parts, each of which is individually selectable and have its own properties that can be viewed. For example, a Schematic Component might contain a number of terminals (or pins), some lines that represent the symbol shape and some text. The terminals will also have their own properties, such as shape and size etc.

In addition to item properties, there are also **Design Properties** and **Document Properties**. **Design Properties** are used to show design based information, such as **Attributes** and the **Associated Parts**. **Document Properties** shows general statistics about the current design being edited, plus you also have the **Inspector Bar** to use.

Design item properties can be viewed by selecting the item and clicking on the **Properties** option from the context menu. The example below shows the **Properties** of an **SCM Star Point**.

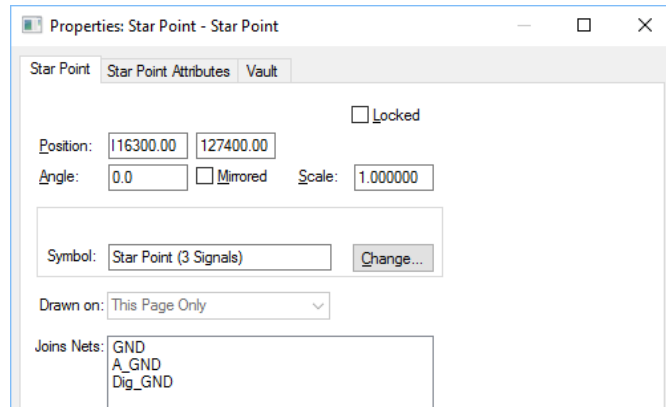

You can also select the item and click the shortcut key <I> (this is the installed default and can be changed if required).

From the **Properties** dialog you can view detailed information about the item selected and can also use it to make changes, such as the items name, its rotation/mirror status (if relevant), etc. Major item changes can also be made, such as a change to the footprint style from DIP to surface mount for example.

Multi-Item Properties

The **Properties** dialog is also capable of changing multi items of the same type. Only items of a similar type can show their Properties together. If the selection includes dissimilar items, Properties will not be available.

The example design over shows the selection of multiple gates of a Part but one of the gates is rotated. All of the gates belong to the same device (U1) and all have different Positions in both the X and Y direction. In the design, only one gate has a different X position because it has been rotated, as shown by the Angle. The Y position would be different because they are placed in a line. All other details are the same.

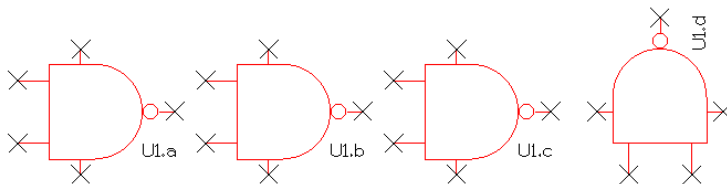

From this dialog you could now make all the gates the same rotation by changing the **Angle:** to a set value, and change their **Position:** in the Y axis so that they were all aligned vertically with each-other.

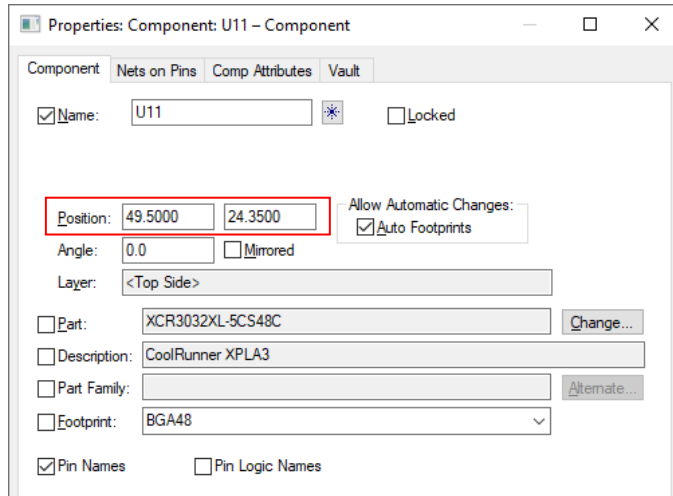

Once this was done, the <Different> indicators would show a value. This would be reflected in the item changed in the design.

Attributes

Another use of the **Properties** dialog is for adding attributes to design items. From the **Attributes** tab you can assign an attribute name and value, you could add a <Hyperlink> attribute on the **Comp Attributes** tab for example.

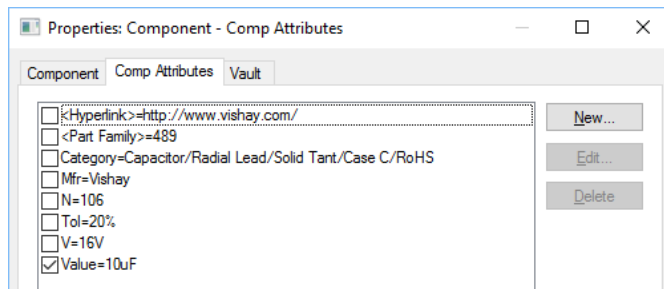

You can also opt to show the attribute on the item by selecting the check box on the left of the attribute name and value.

Adding Attributes from a file

With the **Attribute Properties** dialog you can also take an external text file or selected text and simply drag and drop it onto the attributes page.

The whole text file can be dropped onto the attributes to add new attributes or edit/update existing values. The format must be in *attribute=value*, such as MFR=Motorola. Partial text values can be cut and pasted into the attributes page if you prefer not to use the whole text file.

Chapter 3. General Utilities

Undo/Redo

Pulsonix contains unlimited multi-level Undo and Redo capabilities for use through the product. Undo can be used to reverse the last operations that have been completed. Undo can be used sequentially to undo more than one operation. It can also be a useful and flexible tool to interactively try different iterations of an operation, manual routing for example.

If you use lots of Undo levels, this will use up your memory. In this case, you should either install more memory or restrict the number of Undo levels.

Undo and Redo steps are only available back to the maximum number of levels set. Not all operations are available to Undo/Redo, a list of unavailable operations is listed in the on-line help under *Undo*.

The number of Undo levels is set up in the **Tools** menu under the **Options** function and **General** tab.

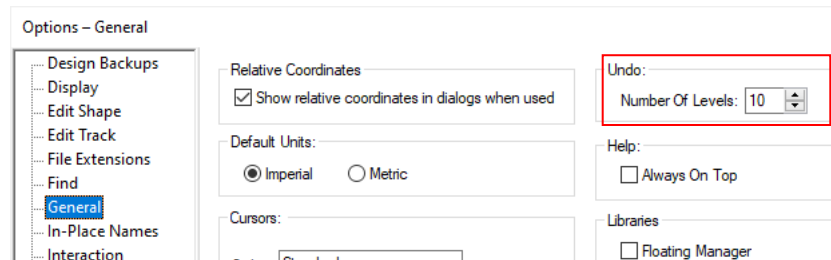

With any Undo level set, say 4, when the fifth Undo step is required it will overwrite the first operation in the Undo buffer that is then lost. So care needs to be taken if using restricted levels of Undo.

Using Undo and Redo

Undo and **Redo** are invoked using the standard Windows shortcut keys <Ctrl-Z> and <Ctrl-Y> respectively. These have been defined as part of the installed set of default keys but can be changed if required; these are also available on the **Standard** toolbar as buttons. **Redo** is only available once an **Undo** has been performed, until then, it remains on the menu but is greyed out as unavailable.

Interactive Operations

Overview

During operational use of Pulsonix there are a number of interactive operations that allow items to be moved, rotated, mirrored and edited. The following sections cover this collective set of features and describes their use and how to set their mode of use where applicable.

Moving Items

There are two methods of moving objects in Pulsonix. The first and most widely used is the **drag and drop** methodology, for use when an interactive move is required. This is modeless in that it can be used without a mode selected. The second method is the **Move** mode. This can be accessed from the **Edit** toolbar button and from the context menu. It allows you to move items with the mouse button left up.

By clicking on any item in the design you can use click and drag to move that item. Depending on how much of the item is selected depends on what is moved. For example, if a segment of a shape is selected and dragged, the segment will be 'stretched' until released. If the whole shape is selected, the whole shape will be moved to a new location. Components are a special case for this type of move. When a Component is selected and regardless of how much of the Component is selected, the whole Component is moved. The Component is made up of individual entities 'grouped' together to form the Component library shape, thus it acts as a complete unit when moved.

The alternative methods for moving items are to select the item first and click the **Move** button from the **Edit** toolbar, or **Move** from the context menu. Once in Move subsequent options are the same.

You can also use Move in **Latched** mode. This means that Move can be selected from the Edit toolbar first, and then applied to items within the design. This mode will be retained as long as the Move button is latched. This option can be unlatched by selecting another option or by selecting the **Select** button or by pressing the <Esc> key.



When in any move operation, a single click of the mouse will release the item in its current location. During this operation a modal cursor is displayed (this must be switched on in the **Options** dialog and **General** tab).

During any move operation the **context menu** can be accessed to provide additional options for use, for example, **Rotate**, **Mirror**, **Layer**, **Style** etc. The options available depend on the current application and the item the Move is being applied to.

The context menu example is split in half to show the extensiveness of the options available:

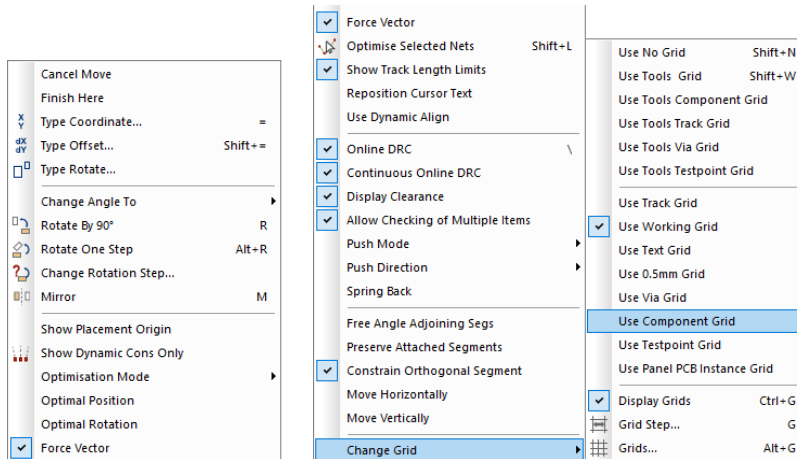

The context menu above shows typical functionality found when in the Move option. This example is for the **Move Component** option.

When using Move, a **Grids** selection is available from the context menu, please refer to the next section headed **Grids** for more information.

Line segments that are **Mitred** or **Curved** can also be moved but will retain their size and make the adjoining segments each side dynamic. To edit or move a Mitre or Curve you should use the edit facility. This can also be accomplished by double-clicking the mouse on the segment to be edited and then dragging the segment to the required position.

The ends of straight line segments and corners in general on open shapes can be moved by selecting the end of the line and dragging it.



A small circle appears at the end to indicate that it is the end segment that has been selected. From this point you can drag the line item to resize it.

Mirror

Mirror can be used on most items within the design including connections in Schematics. Sometimes also known as 'Flip' but called Mirror in Pulsonix. It is available from the **Edit** toolbar, using the shortcut key <M>, and from the context menu when an item is selected or being moved. Mirror is also available from the context menu within the Item Properties dialog for some items. It is not available for all selected design items.

Mirror can also be used as part of **Move**. During the moving of an item **Mirror** can be selected from the context menu or from the keyboard using the shortcut key <M>.

Mirror in Schematics

Within Schematics, Mirror will flip a Component or Documentation Symbol using the centre of the symbols bounding box as the axis point. Text in Schematics cannot be mirrored.

When used with **connections**, **Busses** and **Shapes** within Schematics any dynamic segments can be mirrored across to their opposite diagonal point. This applies to any two segments but does not apply to more than two segments or less than two segments.

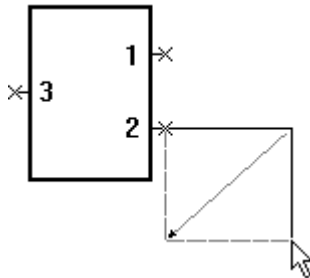

Mirror in PCB

When used in the PCB editor, **Mirror** has three effects. The first will flip the complete Component, Documentation Symbol and Text to the other side of the design (if the alternative opposite side is available). When surface mounted components (with surface mounted pads defined on a surface layer) the pads will also be mirrored to the other side of the design automatically. The second effect will work on whole design shapes and will mirror the shape on the same layer. The third mode will work on any two dynamic segments.

Mirrored Components

Components and Documentation Symbols are mirrored around their Component origin axis to maintain their position. The diagram below shows how the Component will look after rotation but has been moved over to the right for clarity.

The axis points would actually be coincident once mirrored.

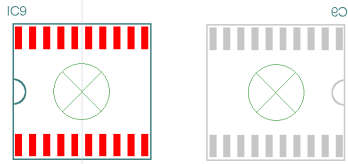

Where whole shapes are selected, the shape is mirrored about its origin. This would be the pick point of the shape; in the example below the axis would be the edge of the shape.

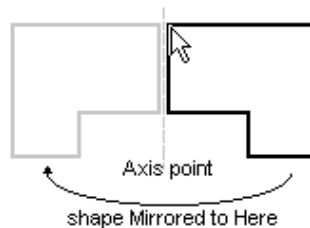

Where two dynamic segments are being edited, the segments are flipped to their opposite diagonal corner. The two examples below show the track segments flipping, and the dynamic segments of a shape flipping.

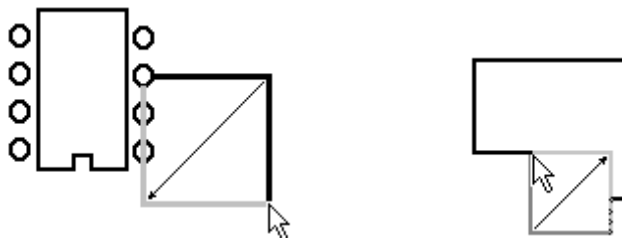

Mirror can also be used in **Latched** mode. To use this, select the Mirror button from the Edit toolbar, and apply it to each item selected. You must deselect the option by selecting the **Select** button or another option before Mirror is unlatched.



When used in this mode, a modal cursor is available.

Rotating Items

Rotate can be used on most items within the design. It is available from the **Edit** toolbar, using the **<R>** key as a shortcut, and from the context menu when an item is selected or being moved. Rotate is also available from the **Item Properties** dialog for some items either single or multiple items of the same type (it is not available for all design item types). This is particularly useful if a number of components are selected for rotation to the same angle, for example.

When **moving** an item, **Rotate** can be selected from the context menu or from the keyboard using the shortcut key **<R>**. For ease of use, rotation steps can be taken from the context menu as steps of **90** degrees, or **Rotate One Step** to rotate by 90 degrees.

Rotate can also be used in **Latched** mode. To use this, deselect everything and select the **Rotate** button from the **Edit** toolbar, and apply it to each item in turn. You must exit the option by selecting the **Select** button or another option.



When used in this mode, a modal cursor is available

Rotation steps can be defined down to **1/100,000th** of a degree, this level of precision allows accurate rotation of items when using polar/radial grids. The precision and rotation unit type of **Degrees** or **Radians** can be defined from the **Settings** menu under **Angle Units** on the **Units** dialog.

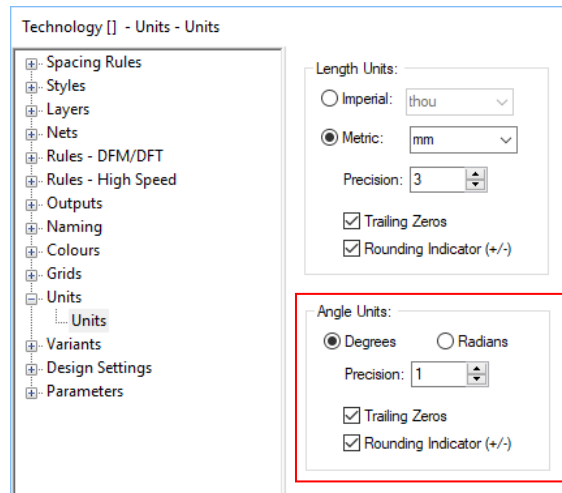

When using the rotation modes, the setup of the angle for which items use is defined from the **Tools** menu and **Options**. From the **Interaction** tab use **Rotation Step** to set the **default** rotation step of any item rotated.

Rotation steps are always defined in an anti-clockwise (Counter-clockwise) direction but can be defined in a clockwise direction by specifying the rotation step as a -ve (negative) number, e.g. -90 (degrees). Normally the rotation steps would be specified as a positive number. Rotation steps can be specified in any value or part value by typing in the number required.

Polar Rotate

Check this box to change the two edit boxes to accept an **Angle** and **Magnitude** to define the position of the selected items using absolute polar coordinates applied about the rotation point. The selected items will be rotated about the rotation point until their origin is at the required angle and then moved towards or away from the origin until the distance from the selection origin to the rotation point is equal to the required magnitude.

Special cases of rotation

Bus Terminals in Schematics

The 45 degree line emerging from a bus is called a bus terminal. This terminal can be setup to be always Up or Down (and Left or Right on horizontal busses) but can never be mixed to show both Up and Down (and Left/Right).

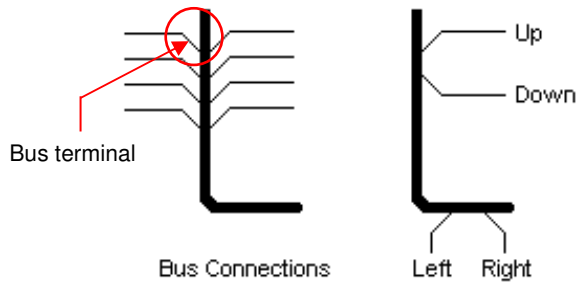

The default direction of the bus terminals is set in the **Design Settings** dialog, under the **Defaults** tab. Once a direction has been set and a bus terminal used on the design, the direction can be changed using the **Rotate** option.

Readable Text in Schematics

When any item containing text or any text item is rotated in Schematics, the design can be setup so that the text is always readable from the bottom or the right of the design page. If the text item is rotated further than an angle that makes it unreadable it is automatically rotated back to a readable state. This mode is set in the **Design Settings** dialog under **General** and is defined setting the check box under **All Text** to **Adjust To Readable Orientation**.

This mode can be overridden for individual terminals by using the **Ignore Readable Orientation** check box in the **Text Properties** dialog. This is also available in the **Attribute Properties** dialog. Selecting this switch disables the effect of the **Adjust To Readable Orientation** switch (from **Design Settings – General** dialog) for that specific text instance..

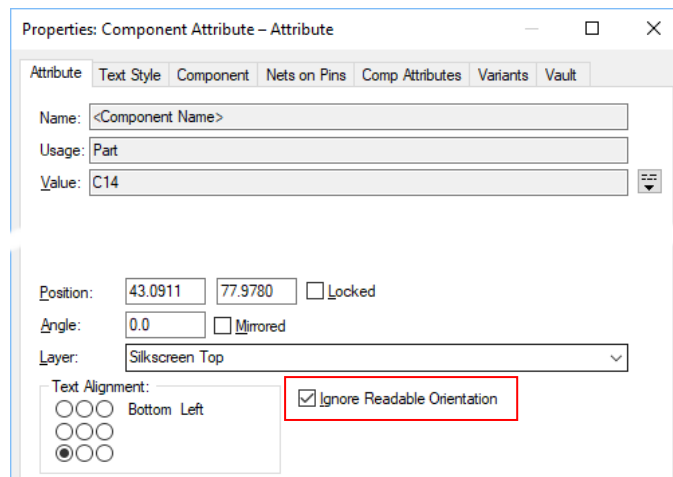

Grouped Items

Grouped items (from **Frame Select**, **Polygon Select** or **Multiple select**) can be rotated and done using the centre point of the group as the rotation origin from where they are rotated. The bounding box of the group includes any text or origin items as well as any visible or invisible items.

Design Repositioning

The complete design may need to be rotated during the design process. This can easily be achieved by right clicking the mouse in an area of free space on the design. From the context menu select **Reposition Design**. You can apply an **X** and **Y** positional shift or just apply a **Rotation** to the design.

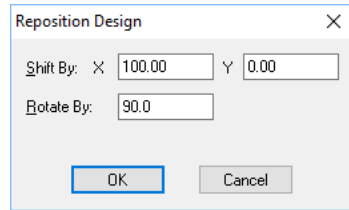

Design Rotation for Output

The complete design may require a rotation from **Landscape** to **Portrait** for example, to allow it to fit on a paper page when plotted. This is not required if this is the sole requirement, the CAM/Plot output feature enables you to plot the design rotated by the simple use of a Rotate Design check box on the Plot Positioning tab.

Lock and Unlock

Lock is used to fix design items so that they cannot be moved or edited. Unlock is used to 'release' or Unlock the item following a Lock operation.

It is available from the Utilities menu and the Edit toolbar and from the context menu when an item is selected. Lock is also available from the **Item Properties** dialog.

Unlock is only available on the context menu after a Lock has been performed on an item.

Lock and Unlock can also be used in **Latched** mode. To use this, deselect all and select the Lock button from the Edit toolbar, and apply it to each item then selected. You must exit the option by selecting the **Select** button or another option.

Model cursors are available to show the current Lock or Unlock mode being used.

When attempting to perform an operation on an item that is locked you are presented with a warning dialog from where to make a choice of which action to make:

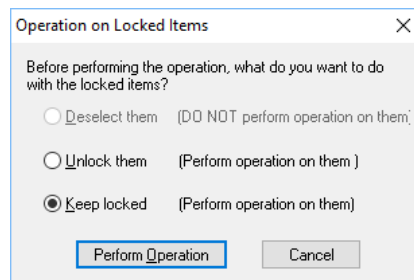

This dialog tells you that the item is Locked but also gives you the option of continuing with the operation requested.

By selecting one of the radio buttons, then the **Perform Operation** button, the operation can still be performed but is completely under your control. You also have the opportunity to not perform the operation, if selected by mistake for example.

Special cases

Importing from other systems

When importing a design from another system using one of the built-in import filters, some items are automatically locked in place when the design is viewed in Pulsonix. These items can be subsequently unlocked using the Unlock option.

Track Locking in the Auto Router

While using the integrated auto router option, you have the ability to lock tracks that already exist in the design and to lock new tracks added by the auto router. Once subsequently using the interactive features of Pulsonix you can lock or unlock any tracks as normal anyway.

Track Locking

Tracks can be locked in the PCB design editor. This maybe particularly useful when using 'fanout' type track patterns on a Component as it will prevent accidental removal of tracks and vias from the design. If using the auto router, you also have additional control over their removal, see above.

Locking Vias

Vias can be locked in isolation to the tracks that they are connected with. This will prevent their removal even if connected to tracks that become deleted. You may have critically positioned the via in the design and allocated it as a Testland. Even with no tracks connected to it, the via still remains connected as attached to the net.

Cut, Copy, Paste and Duplicate

Cut and **Copy** are used to copy and remove items from the design and place in the clipboard, or to take a direct copy of an item and place into the clipboard respectively.

Paste is used after items have been placed in the clipboard (from using Cut or Copy) and adds them to the design.

Duplicate is used to copy item(s) and paste them into the design. This option is used for direct copies within the same design.

All of these options can be used on all design items. They are available from the **Standard** toolbar, as shortcut keys from the keyboard, and from the context menu when an item is selected. These options are also available as menu options from the Edit menu.

As a default, the shortcut keys in Pulsonix include the standard Windows shortcuts where available but these can be redefined if required.

Cut	<Ctrl-X>
Copy	<Ctrl-C>
Paste	<Ctrl-V>
Duplicate	<Ctrl-D> and <Ctrl-drag>

As an additional shortcut method to using Duplicate, you can also use <Ctrl-drag> while making a selection. Instead of moving an item, the item is duplicated and the new copy moved ready for release in its new position.

These options are available on selected groups of items regardless of whether they are similar or not. The same rules apply to groups as for individual items or multiple selected items.

Special cases and rules of operation

Paste/Duplicate into the same design will cause the **Resolve Net Names** dialog to be displayed if the selection contains any named nets. If the selection only contains default net names the net names are automatically incremented to the next available in the sequence while being added to the design. Any Component names within the selection are also automatically incremented to the next available in the sequence.

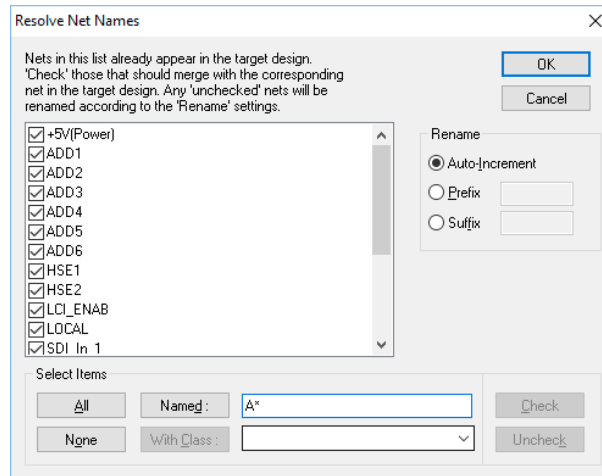

Schematics

If the selection contains a portion of a multi-gated device, the unselected gates or unused gates are added to the Component Bin for later use.

While **Duplicate** cannot be used across pages, **Paste** can be used. Selected items can be **Cut** and **Copied** to other sheets if required.

Items being **Pasted** onto a page are checked across all pages, this applies to both net names and Component Names.

Safe Mode

When using Pulsonix in **Safe Mode**, **Paste** and **Duplicate** will not be available if it means adding in new design items that change the netlist in any way. In this mode, if you wish to change or add design items you must return to the Schematic design and make the changes there before using **Synchronise Design** to make the changes to the PCB.

Copy to another shape type

When using **Copy/Paste** on a shape, the shape can be added to the design as a new shape type.

Before pasting the new shape into the design you put Pulsonix into the **Insert Shape** mode required for the new shape. For example, if copying a **Board Outline** shape to a **Template** shape, you should copy the board first, then select **Insert Template** shape and **Paste**. The new copied shape will be exactly the same shape as the board outline but will be a template ready to be placed. While in this Insert state, more options are available from the right mouse button, change layer, change style etc.

Grouping Items

Items in the design can be grouped together for moving etc. When more than one item is selected, the **Group** option appears on the context menu. Selecting this option causes all the items to be added to a new group. If the items are deselected and then one of the items is selected, all other members of the group become selected.

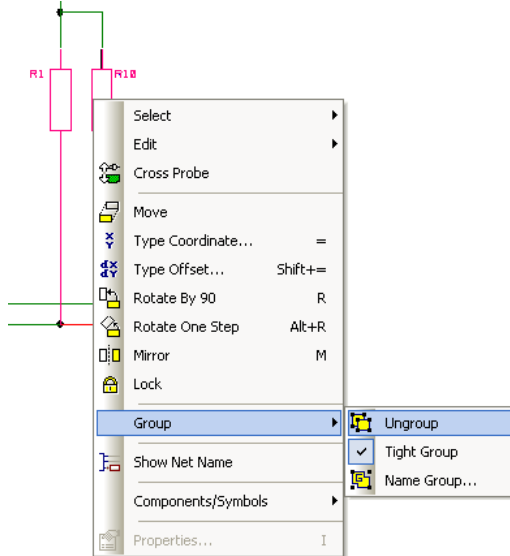

If the group is to be named, select the group and select **Name Group** from the context menu.

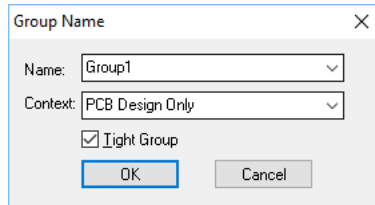

Groups can be named and the group and name passed through from Schematics to PCB designs. If the group is to be translated to PCB, it must be named. Named Groups can be managed using the **Technology** dialog and **Group Names** tab.

	Name	Tight	Context
Y	Group1	<input checked="" type="checkbox"/>	All Designs
	Processor (Support)	<input checked="" type="checkbox"/>	All Designs

Groups are created as **Tight** groups, that is all members of the group act as one. If you want to make changes to individual members of the group, change the group type to **Loose**. This can be done by selecting the group and unchecking **Tight Group** on the context menu. Any group member when selected will then act individually. To change back to a tight group, select any member of the group and check **Tight Group**.

Create PCB Group from SCM Block

You can also mark a **Block** instance (using **Block Properties**) to **Create a PCB Group** when in PCB. The equivalent group is added to the **PCB** and **Synchronise Design** will keep them in-line. The group has the same name as the Block, with an optional prefix (which is defined in the PCB, see below).

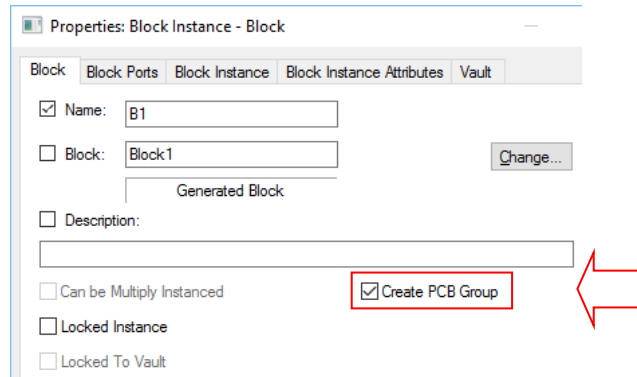

Block Name Prefix

If required, set the Block Name Prefix for use in the PCB from the **Technology** dialog, **Design Settings – General/Defaults** and **Defaults** button. Choose **Block** and type the name of the **Block Group Name Prefix**:

When viewed as a group, the name will look like this, showing the **Prefix** first, followed by the **Block Name**.

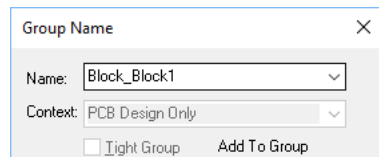

Deleting Items

Delete can be used on almost any item within the design. Some exceptions are detailed in the *Special cases* section below. Delete can be used to delete selected item(s), or can be used in latched mode where the Delete option is selected first and applied to items within the design. When used in latched mode you can only exit it by selecting the **Select** button on the toolbar or another option.

The **Delete** option can be selected by pressing the **Del** key on the keyboard or by using the **Delete** option from the **Edit** menu, or the **Delete** button on the **Edit** toolbar, or the **Del** option on the context menu.

There is no confirmation to delete, however the **Undo** option can be used to recover any deleted design information, provided an option hasn't been used that removes the Undo levels from memory.



When Delete is used in Latch mode, a modal cursor is available.

There are 3 different ways to perform delete that are relevant to a Component or Symbol, for all other item types the Delete function deletes the item.

- Unextended Delete will just delete the Symbol leaving any connections ‘dangling’. This can be used in conjunction with the Auto Weld option in Schematics.
- Extend Delete will delete the Symbol and connections leading from the pins on the Symbol back to the pin or junction at the other end of the connection.
- The default Delete option behaves as Unextended Delete in Schematics and as Extend Delete in PCB.
- The default hot key for Delete is the Delete key, with Shift-Delete for Extend Delete and Ctrl-Delete for Unextended Delete.

Special cases

Schematics

Deleting one gate of a multi-gate Component will not remove the Component completely if one of the other gates on the Component are still being used. It will put the deleted gate into the Component Bin as unused. This will happen to each until the last gate of the same Component is removed from the design, at this point all the gates for that Component will be removed from the Component Bin as well.

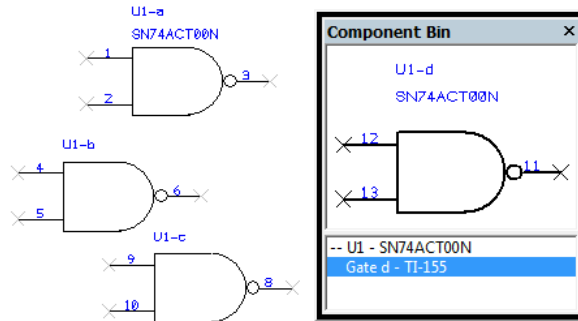

In the previous example shown, if four gates of U1, a 7400 device, are placed on the design, when U1-b is deleted it appears in the Component bin and U1-a,c,d remain on the design. Finally, with just one gate left on the design, U1-c say, all other gates appear in the Component bin. When U1-c is removed, U1 with all four of its gates are removed from the Component Bin and the design.

Safe Mode

In either of the design editors you can run Pulsonix in **Safe Mode** (by selecting this mode in the **Options, General** dialog). This means that the netlist (nets and components) cannot be changed in that design editor without using the **Synchronise Design** option. In this mode, you cannot delete any nets or components that would affect the netlist. Safe mode can be chosen for either the Schematic or PCB designs depending on which one you select as your ‘master’ design.

Deleting Nets/Tracks

To remove a connection in PCB you must use the **Remove From Net** option from the context menu once the connection has been selected.

Delete on tracks in PCB has the same effect as **Unroute Track**. If you want to remove the track and the connection, you must use **Remove From Net**.

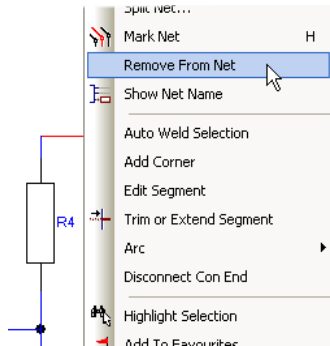

These modes can be used when the PCB is in context, i.e. either as the master when used with a schematic design or when being created without a schematic design.

Inserting Text

Single line and multi-line text can be added to both Schematic and PCB designs as well as library items. The style of the text used in the design is defined in the **Technology** dialog under the **Text Styles** tab.

From the **Technology** dialog, you can also change the **Text Styles** to also include **TrueType** fonts as an alternative to the standard 'stick' system stroke font.

	Name	Height	Line Width	Font	Underlined
	Attributes	50.0	5.0	<System Stroke Font>	<input type="checkbox"/>
Y	Component N	50.0	5.0	<System Stroke Font>	<input type="checkbox"/>
	Errors	50.0		Arial	<input type="checkbox"/>
	Header	80.0		Arial	<input type="checkbox"/>
Y	Logic Names	50.0	5.0	<System Stroke Font>	<input type="checkbox"/>
Y	Net Names	50.0	5.0	<System Stroke Font>	<input type="checkbox"/>
	Normal	50.0	5.0	<System Stroke Font>	<input type="checkbox"/>
Y	Pin Names	50.0	5.0	<System Stroke Font>	<input type="checkbox"/>
	Table	150.0	10.0	<System Stroke Font>	<input type="checkbox"/>
	Table Small	100.0	10.0	<System Stroke Font>	<input type="checkbox"/>
	Title	200.0	20.0	<System Stroke Font>	<input type="checkbox"/>

The **Name** is used to define the name of the text style when used in the design. The **Width** and **Line Width** define the character width used and the thickness of each line 'stroke' making up the character. The **Font** can be defined from the list of installed Windows system fonts and the default <System Stroke Font>.

As with all styles to be used in the design it is more efficient to define a range of relevant styles for Text. This will allow you to categorise the text being added into types, this makes it easier to change all of a type by changing the style values.

You can also define text styles as you insert text into the design using **Change Style** from the context menu or pressing <S> on the keyboard.

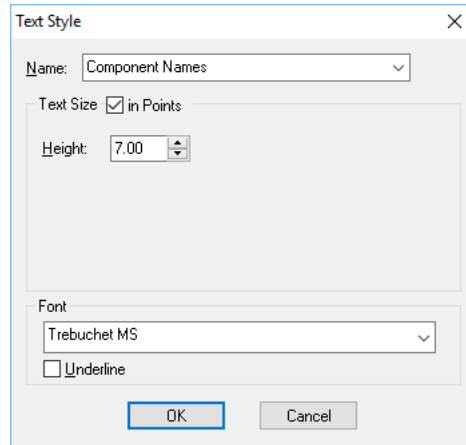

From this dialog you can change the **Size** and **Line Width** of the text but will also allow you to change the style name or use the default style name presented to you. The style presented in this dialog is added to the **Technology** dialog under Text Styles. It can only be edited in the Technology dialog and not in the Text Styles dialog where it was initially added. This feature is in addition to adding the text style to the Technology dialog directly as part of setting up your design styles. If using this method you should also remember to alter the Technology file if the styles are required in other designs. Technology files are described in the next chapter.

In PCB, text that is added to electrical layers becomes an electrical 'block' that is checked during **Design Rules Checking** and **On-line DRC**, and that has its own (Text) **Spacing Rules** defined in the **Technology** dialog. Text on non-electrical layers is not checked.

The text origin can be changed for each individual text string. Multiple text items can also be selected and their origins changed together. Once the text items have been selected they can be changed through the **Item Properties** dialog on the context menu. You can select from one of nine **Text Alignment** positions. By default, the text position is always **Bottom Left**, this can be changed through this dialog or by using the **Change Text Alignment** option from the context menu.

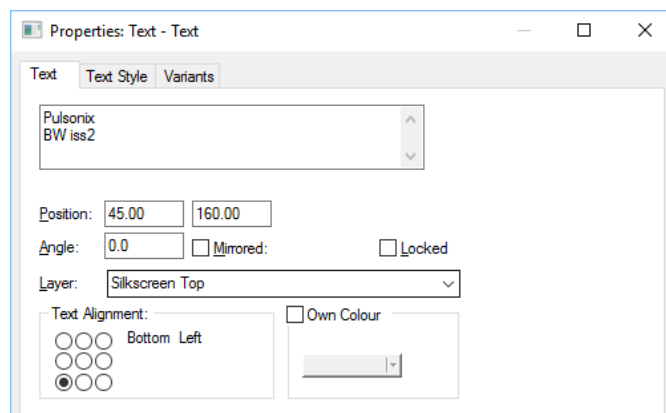

You can also change the colour of text items to contain their own colour rather than that defined in the **Colours** dialog for **Text**. Care should be taken when changing the colour of particular text items so that there isn't confusion identifying the layer for example that the item appears on.

The text font can be changed from the **Properties** dialog also using the **Text Style** tab.

Vertical Text Alignment for Multi-line Text

The switch, **Multi-Line Text Vertical Align**, in **Design Settings, General**, under **All Text** enables you to set the text position for multi-line text in the vertical axis. When enabled, this causes all multi-line text to vertical align using the height of all the text, not just the first line alignment. This is a design setting, so it will change the vertical alignment of all multi-line text in your design so care must be taken if applying this after already having added multi-line text, especially on electrical layers.

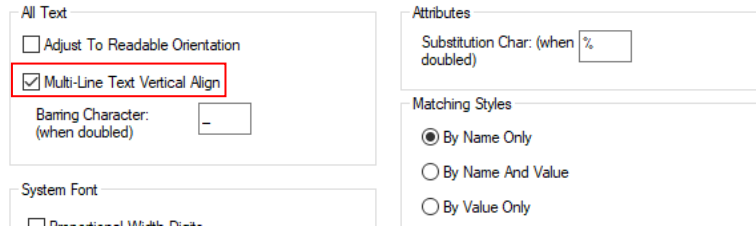

The two images below show the effect of this switch. To clarify where the alignment is taken from, horizontal and vertical construction lines have been added to the text to show the movement.

The left image is before switch is activated (and as current product), the right-hand image is after:

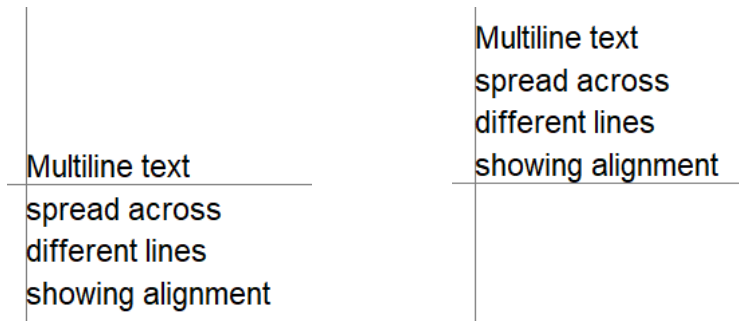

Special cases

Pulsonix has the ability to cope with special text cases where formatting or style is required.

Force to Upper Case

By defining what text items should be forced to upper case (capitals) it then makes no difference whether upper or lower case text is typed in, the text will always appear in upper case. This is particularly useful for Component names that by default are forced to upper case.

This feature is setup in the **Technology, Design Settings** dialog on the **Naming** tab. It is recommended that unless experienced with Pulsonix you should not change it.

Case sensitive pin names

The case sensitivity of pin names can be changed using this check box. This means that both upper and lower case text can be typed in and the system recognises the differences, even if only subtle. For example, differences such as **A1** and **a1** would be understood, even if you typed one of them in by mistake!

This mode is set in the **Design Settings** dialog under **Naming** and is defined by setting the check box under **Pin Names** to **Case Sensitive**.

Adjust text to readable orientation

When any item containing text or any text item is rotated in Schematics, the design can be setup so that the text is always readable from the bottom or the right of the design page. If the text item is rotated further than an angle that makes it unreadable it is automatically rotated back to a readable state. This mode is set in the **Design Settings** dialog under **General** and is defined setting the check box under **All Text** to **Adjust To Readable Orientation**.

► To add text to the design

1. From the **Insert** menu, select **Insert Text**.

2. Type the required text into the window.

The text can be upper and lower case. Multi-line text can be added by pressing <Enter> at the appropriate places. You can use all the normal text editing facilities including copy and paste. The full ISO-Latin-1 character set is supported. You can also add barred text using the barring character.

The Insert Text dialog changes slightly between the Schematic and PCB design editors shown below:

- On completion click **OK** and position the text.
The schematics **Insert Text** dialog has a drop down list for drawing on **All Pages At This Level**. Whenever text common to all pages is edited, the changes are reflected through all the pages. This is useful within company sheet outlines that are the same on all pages for example.
- The text will be positioned at the end of your cursor.
- Use the mouse to position the text at the exact location required. During positioning, you can use the options on the right hand mouse context menu to: **Mirror** or **Rotate** the text and also change the text **Style** and **Font**. The justification of the text string can be altered by selecting the text and using **Properties**.
- To release the text, click the mouse. This will release the current text item and put you back into the **Insert Text** dialog. Click the <Esc> key to exit this mode.

Barred text

Barred text can be added to the design (both Schematic and PCB). There are two steps to enable barred text. The first is for the definition of the barring character in the **Design Settings** dialog under the **General/Defaults** tab.

This by default is the underscore () character but can be changed if required. The second is to enclose the text string to be barred with the barring character. This must be doubled both before and after the text string to enable the bar.

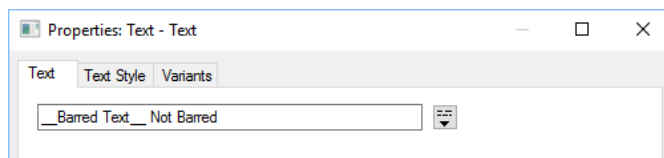

In this example the words **Barred Text** are enclosed with **double** underscore characters and the words **Not Barred** are not enclosed to highlight the differences. There is a subtle space character between the ending barring character and the word 'Not'.

When added to the design, the text appears like this:

Barred Text Not Barred

Mitring and Filleting Corners

Mitres (45 degree corners) and **Filletts** (curved corners) can be added to any shape or line item, including PCB tracks and Schematic connections. Mitres can only be added to 90 degree corners on straight segment lines. There are a number of methods for adding and editing them.

Mitres and Curves behave in the same way and are added and edited the same way.

Basic adding of Mitres

Starting with two orthogonal segments creating a 90 degree corner, a Mitre can be added by double clicking on the corner. You must double click rather than picking and dragging, the pick drag function will move the corner and segments rather than adding the Mitre. You can also select the Mitre Corner option from the context menu if the corner is selected.



When Mitre Corner is used, a modal cursor is displayed.

The Mitre is a free moving 45 degree corner on the two orthogonal segments. This snaps to the grid points of the Track Grid or the Working Grid/Free Grid that has been previously used when inserting the shape or track. By using a grid rather than leaving the Mitre to be a free grid segment you can ensure that the corners of the Mitre are always on-grid.

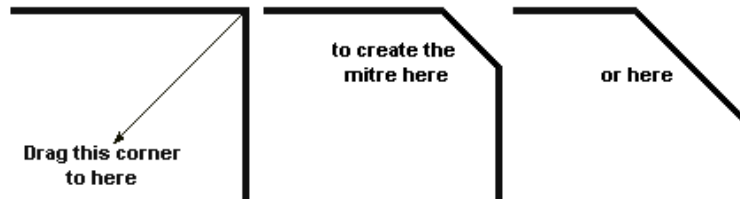

Once inserted, Mitres can be easily edited by double-clicking on the 45 degree segment. To remove a Mitre, double click on it and drag it out to make it a 90 degree corner again.

For connections in Schematics you cannot use the double-click method, you must first select the corner and then use the **Mitre** option from the context menu. If you use the double-click method of editing an existing corner, the program will attempt to insert a connection and will therefore add a junction point to the corner instead of editing it.

Fixed Mitre sizes

If you require all Mitres to be the same size, you can set the size and set the snap to this size when the Mitre is inserted.

The **Mitre** size is set in the Options dialog under either the **Edit Track/Connection** tab or the **Interaction** tab, depending on what type of item you are editing. Editing options of shape items except for Tracks and Connections (in Schematics only) are set through the Interaction tab. The example tab shown below is for Interaction but the information presented is the same for the Track and Connection tabs as well.

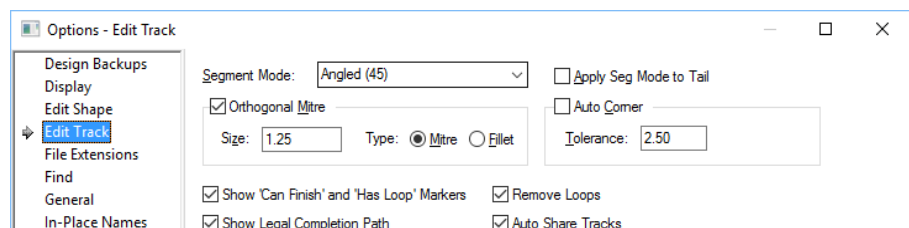

The setting used is Under the **Orthogonal Mitre** and **Size**. The Size will be set in the current Design **Units**. Orthogonal Mitre does not need to be selected for this option to operate. This is only selected if you require Auto Mitring to be operational, see below for description.

To use this default Mitre size you must first be editing the corner. With the corner selected you can right mouse click and select **Mitre Corner** from the context menu, this will edit the corner. If you immediately right mouse click again you can select **Default Mitre Size** from the context menu. This will snap the Mitre to the default size set in the Options dialog.

From the context menu, you also have the option to **Fillet** corner to make it curved.

Chapter 4. Setting Up The Design

Overview

There are a number of features and options that allow you to setup a design prior to starting the actual design work itself. Some of these features are highly desirable, like setting up the working **Units** for example or the interval of the **security copies** of the design. Others are not essential but preferences, like changing the colours to your own choice. With the differences between the Schematics and PCB design editors, only the major differences are discussed and some of the more important subtleties.

Using Folders and Files

Folders

When saving files you can set up the save locations. The **Folders** option on the **Setup** menu contains the path setup information in one dialog of all the options that use paths. By default, during Setup the paths within the Folders dialog are set to the standard Pulsonix installation paths, these can be changed by editing the relevant one.

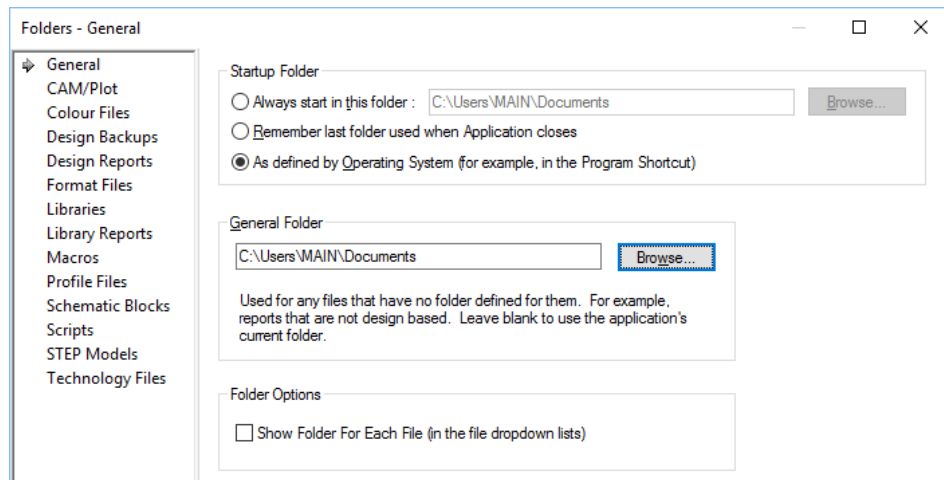

The **General** tab defines the folder the program starts up in and the location that is used for 'general' non-design based reports, such as the shortcut keys report.

The choices on this tab allow you to decide the best start-up location, it may be that you wish to start on a server or a local disk but in a working folder of a particular project etc. There are three options that give you a selection of start-up choices. This tab will allow you to choose a folder that could contain your current working design. When **Saved**, the design will be overwritten at its current location. If **Save As** is used, the current folder of the design will be displayed and you can change this as required.

The **Design Backups** tab is used for specifying the location of **Design Security Copy** files, **Backup Copies** of the design and **Restore Points**.

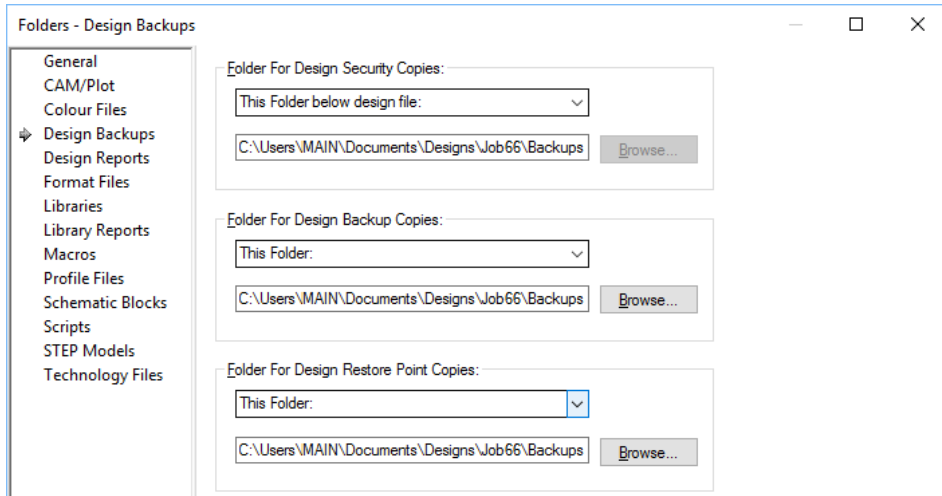

See below under *Security Copies and Backups* for details about specifying the format of the files during save.

The **CAM/Plot** tab is used for specifying the location of CAM files and for specifying the name definition used of the CAM file output.

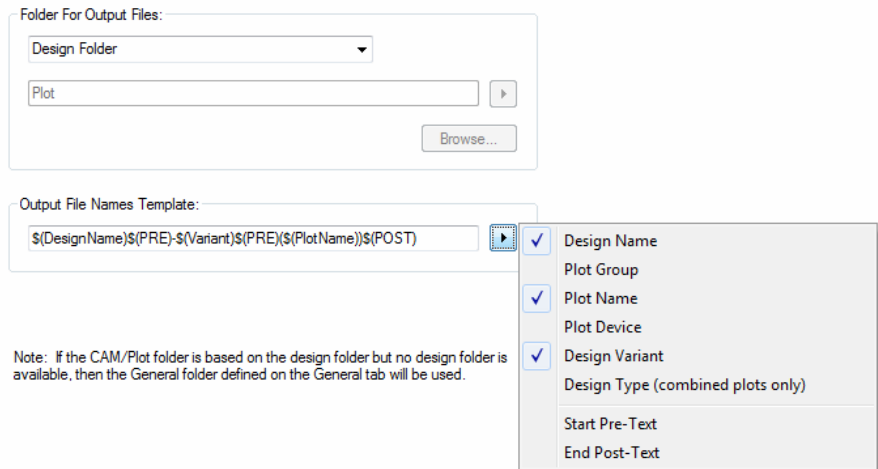

You can define the filename and folder name using keywords that will be replaced with the relevant text when a plot file is created. This allows you, for example, to use the plot group name to separate plots that are project required as opposed to simple documentation. You can also use this section to specify that a particular plot type (PDF for example) will use its own folder to this type. Use the **This Folder below design file:** and set the folder to **\$(PlotDevice)**

Using the **Plot Settings** page in **CAM Plots**, use the **Output File Names Template** section with a template edit box and a popup menu button to make the name creation process more convenient when adding keywords. The popup menu button next to the folder edit box is used to make naming selections.

Most keywords are obvious, but there are a few that need additional explanation:

\$(PRE) and \$(POST) are used to add pre-text and post-text either side of a variable field. For example “\$(PRE)[\$(Variant)]\$(POST)” will be replaced by “[USA]” for a plot for variant “USA” and will produce nothing for a plot with no variant.

\$(DesignType) is replaced by “pcb” for a pcb design and “sch” for a schematic design.

\$(CombinedType) is the same as \$(DesignType) but is only used if the filename is a combined output containing several plots (like pdf).

The **Reports** tab is used for specifying the location of reports and for specifying the name used of the report file output. This has a drop down list, **Report File Names Template** section with a template edit box and a popup menu button to make it easier to add the keywords. There is also a popup menu button next to the folder edit box as well.

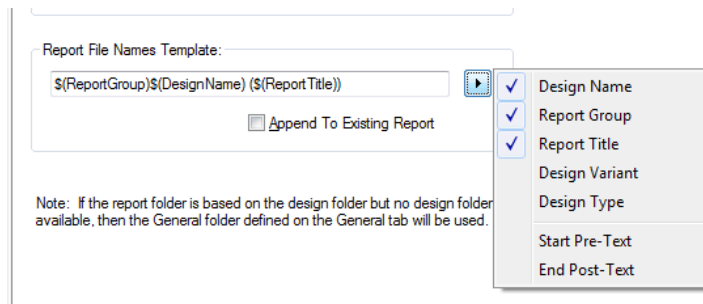

The “\$(Report Group)” keyword will be replaced with the report group the report is in. On the **General Reports** page there is a **Report Group** box to supply the group for each of the standard reports. **User reports** can have a report group assigned by including the new **Set Report Group** command in their script.

This also has the added check box, **Append To Existing Report** which can be used to add the current report to an existing file. This might be useful where an audit trail of events is required.

Libraries, Technology Files, Profile Files, Colour Files, Schematic Blocks and Format Files

The **Libraries, Technology Files, Profile Files, Colour Files, Schematic Blocks** and **Format Files** tabs all contain default locations for these files. Each of these pages allows the Folder selection and the enabling or disabling of files within it. Multiple folders can also be chosen from anywhere accessible by your computer and network.

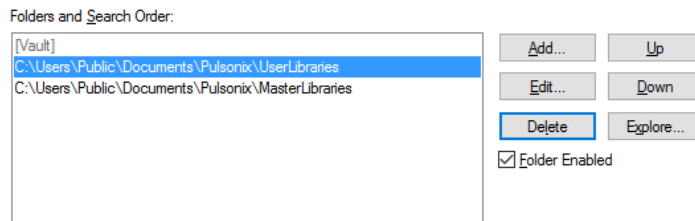

The **Folder and Search Order** panel enables you to choose the folders to include in the search. This mechanism is the same for all four of the file types that appear on this dialog.

The process is to use the **Add** button to add a new folder and **Edit** to change an existing folder path. If unsure where the folder is located or you need to browse to locate it on a network drive, use the **Explore** button. The **Up** and **Down** buttons allow you to position the folder in the search. This is important because if there is more than one item of the same name in the libraries or other files, the

order in which they appear in the search path will be how they are used. The first item required and found will be used.

The **Files Found** panel will display any files found on the search path setup in the **Folder and Search Order** panel. Each file found is displayed along with its file extension to identify its type, and the path it was found on.

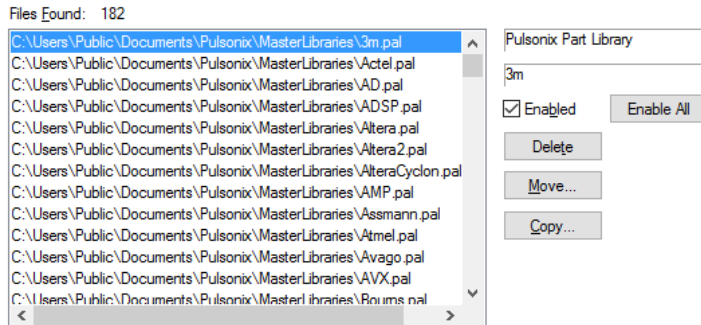

The right hand side of the panel displays the file type when selected, the box below this displays the file name.

You can enable or disable files to be used within the folder by using the **Enabled** check box. By selecting it, the file will be disabled and therefore not used. It does however remain in the search path.

Delete, **Move** and **Copy** are used to manage the files within the chosen folder(s). Be warned though, Delete will erase the file completely from the folder, not just from this search list.

Edit only appears for the folder items that can be edited. The file must be selected from the list in order for the Edit button to be active. This button appears on the **Profile Files**, **Format Files**, **Schematic Blocks** and **Technology Files** dialogs. When a file is selected and the Edit button pressed, the file is loaded into the respective editor.

Files

Saving files is an essential part of any Windows based product. In keeping to the Windows standard, Pulsonix provides both **Save** and **Save As**, as well as other special save options.

Save allows you to save the current design to its existing name. If exiting the design without first saving it, you will be prompted to save the design or discard it. An indicator that a design has been edited but not saved is shown on both the Workbook mode tab and the title of the Pulsonix product as an asterisk (*). Once saved, this indicator disappears.

Save As allows you save the design to a new name using the **Save** dialog.

Save Technology allows you save the technology information in the design to a Technology File. This can be subsequently used when creating new designs to give them the same technology data as this design.

Save Profile allows you save part of a design to a Profile File, for example, the page border or board outline. This can be subsequently used when creating new designs to provide the same Profile data as a starting point.

Each of the save options has its own file extension that are predefined depending on the design type you are saving.

Saving libraries

When using the Symbol, Footprint or Part editors, the menu contains **Save**, **Save As** and **Save Technology** as expected, but also **Save To Library**. Both Save and Save As are used to save the current symbol to a symbol file not the library. To save the Symbol being edited to the relevant library you should use **Save To Library**. If editing an existing Symbol from the Library, the **Save** button on the toolbar will allow you to Save To Library where you will be prompted for the library name and the symbol name when saving.

Security Copies and Backups

Pulsonix has the capability for security copies of your design to be made and you can set the interval and location of the files.

Although Pulsonix has its own system for security copies of designs, we **HIGHLY** recommend that you make regular backups of all Pulsonix designs, libraries, technology files, profile files, reports and security copies.

If at any time you think you have lost or deleted Pulsonix files **DO NOT** shut down the Windows operating system. Call the Pulsonix technical support desk straight away. If you shut down the operating system there is a much stronger chance of not being able to recover the data because of the files Windows writes to disk during its shutdown process.

Within the **Options** dialog on the **Design Backup** tab is a collection of options to facilitate saving **Backups**, **Security Copies** and **Restore Points** of the design.

The screenshot displays three sections of the Design Backup options dialog:

- Create Security Copies:**
 - Checked checkbox.
 - Every minutes
 - Keep copies
 - Keep Copies In: (dropdown)
 - (text field)
 - Filename Format: (text field)
- Create Backup Copy on Save:**
 - Checked checkbox.
 - Keep copies
 - Keep Copies In: (dropdown)
 - (text field)
 - Filename Format: (text field)
- Design Restore Points:**
 - Keep Copies In: (dropdown)
 - (text field)
 - Filename Format: (text field)

User defined format of backup file names

You can create user-defined formats of the backup name by typing fixed text and inserting tags that will be replaced when a backup name is generated.

Design Restore Points

Keep Copies In : Design Folder

Filename Format: Restore Point for \$(DesignName) \$(Label)

- Design Name
- Increment
- Decrement
- Infinite
- Restore Point Label

Tags are defined as the **design name** plus one of three numbering schemes – **Increment**, **Decrement** and **Infinite**.

So for example, if number of copies is 3, Increment will produce copies 1 2 3 where 3 is the latest, Decrement - 3 2 1 where 1 is the latest, and Infinite 12 13 14 where 14 is the latest, i.e. it just keeps getting higher.

For the **Design Restore Points** section, you can also select **Restore Point Label** from the context menu.

Security copies

This section enables you to choose security copy backups of your design that you are editing. They are automatically generated after a set time interval if the contents of the design file you are editing has changed. They provide the security of being able to save copies on a regular basis in case data is lost due to problems with Pulsonix or the operating system.

Create Security Copies

Every 10 minutes

Keep 1 copies

Keep Copies In : This Folder

C:\Documents\Designs\Job66\SecurityC

Filename Format: Security Copy of \$(DesignName)

Backups

These are copies of your design automatically created when you save it. They give you the security of being able to restore the design to one of the recently saved versions.

Create Backup Copy on Save

Keep 1 copies

Keep Copies In : This Folder

C:\Documents\Designs\Job66\Backups

Filename Format: Backup Copy of \$(DesignName)

Save and Load Restore Points

There is an additional backup type called a **Restore Point**; that is saved on request. It is used for saving a design that is in a known good state before starting on a session of changes.

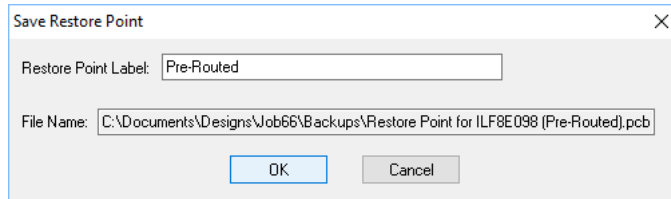

The saved backup is restored using an option on the **File** menu named **Restore Backup...**

From within the **Options** dialog and **Design Backups** page, you must provide a label for the restore point that will be inserted into its name. For this to happen, the name format must contain the **label** tag.

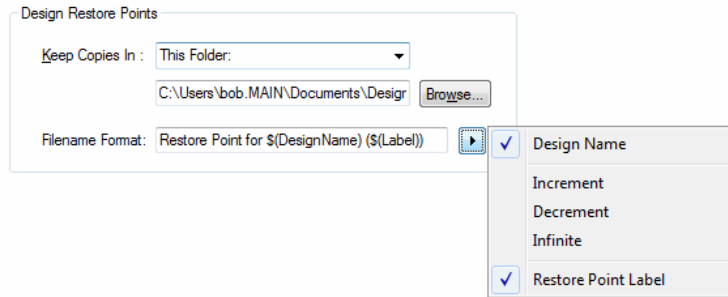

For example if the name format was “\$(DesignName) - \$(Label)” then the user could create a restore point for design “MyDesign.Pcb” after autoplace with the label “Before Routing”, so the backup file will be called “MyDesign – Before Routing.pcb”.

Restoring Backups

There is an option on **File** menu named **Restore Backup...** to restore the contents of a design to be the same as a chosen backup file. This can be performed on the current design, or you can choose the design to have its contents restored from. When selected, this displays a list of backup files to choose from in the dialog.

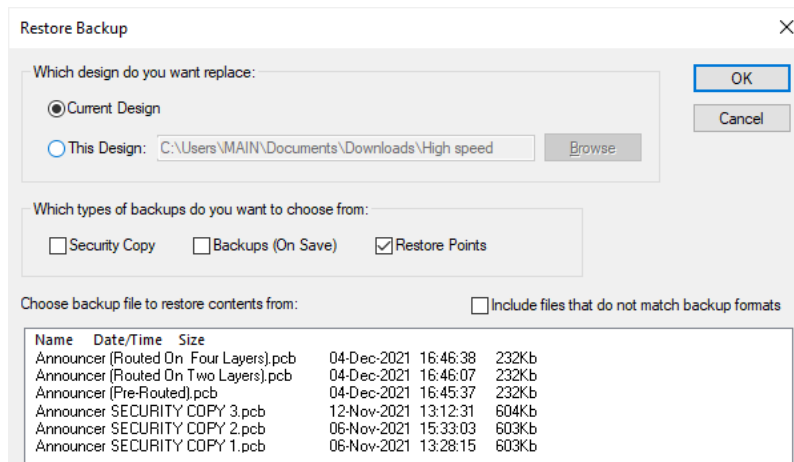

Units

The basic working units can be changed between **Imperial** and **Metric**, and between **Degrees** and **Radians** for angle units. These are the units of the co-ordinates and lengths displayed in the dialogs and edited by you. The **Units** dialog on the **Setup** menu is used to define these units and the precision at which they are displayed.

The design units are stored in an internal database with a precision of 1/100 micron regardless of what the unit precision is set to.

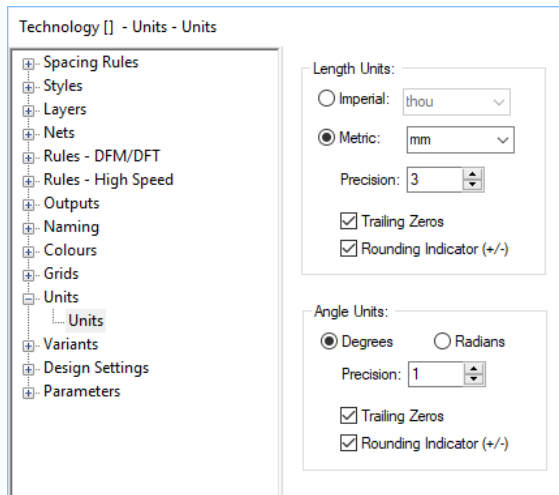

Imperial units can be set to **Inches**, **Thou** or **Mils**, **Metric** units can be set to **Millimetres (mm)**, **Centimetres (cm)**, **Metres** or **Microns**. **Angle** units can be set to **Degrees** or **Radians**. For each type of units, you can specify a precision. This is the number of decimal places displayed; the value is simply rounded to the nearest last digit. If you have the **Rounding Indicator** displayed, a + or - sign is shown at the end of the value to show that it has been rounded down or up. If **Trailing Zeros** are not displayed, the trailing zeros are not shown for values that do not require all the decimal places.

You can quickly toggle between **Metric** and **Imperial** units by using the default shortcut keys <Ctrl-U> or by double-clicking on the unit notation on the **Status Bar**.

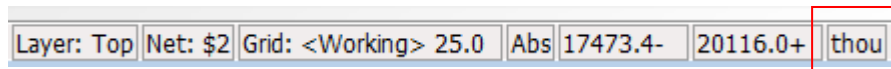

Grids

Grids are used for both visible reference markers and to define the points or steps to which items will "snap" when they are placed. There are built-in grid names that can be setup for use with particular design items, for example, Track grid, Via grid, Component grid, Testpoint grid. You cannot rename or delete built-in grids.

You can specify the **X** and **Y** grid steps and the visibility of grids.

The **<Working Grid>** is a system grid that you cannot rename or delete. This is used for most of the interaction of Pulsonix, and is only substituted in particular cases where a specific option grid is available, for example Component or Testpoint grids.

Setting up grids

The **Grids** dialog allows you to add or change the settings for any of the grids in the design. The **Grids** dialog is available on the **Setup** menu and is stored within your **Technology**. It can also be accessed using the **Grids** button on the **Grid Step** dialog.

Within the standard Pulsonix PCB Technology files are named grids that have been setup for you using names that represent possible design entities, such as component, Testpoint, Text etc. these can be renamed, defined and deleted by you as required.

Name	
Y	Component
Y	Panel PCB Instance
Y	Testpoint
Y	Text
Y	Track
Y	Via
Y	Working

Name: Used:

Relative to Grid:

Displayable

Colour:

Draw nth Step:

Style

Dots

Lines

Crosses

X Crosses

Global Grid Settings

Display:

Step Polar Grid

Basic Step x Multiplier / Divisor = Step

Different X & Y

Origin

X Lock

Y Lock

Lock

Apply Origin Settings To All Grids

A set of user defined grids might look more like this:

Name	
	0.1mm
	0.125mm
	0.500mm
	25 thou
	50 thou
	Placement

Defining your own grids

You can define your own grids by first typing in a name using the **New** button. The grid **Step** should then be typed in and the **Multiplier** (and **Divisor** if required). Use the Multiplier and Divider entries to create fractional grids that do not suffer from rounding errors.

Step Polar Grid

Basic Step x Multiplier / Divisor = Step

Different X & Y

You can also set its visibility by selecting the **Display** setting from the drop down list. Selecting **OK** will save the grid and display it (if the zoom level allows it).

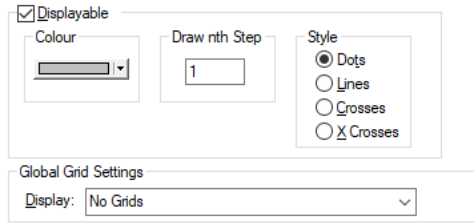

Grids can be defined relative to system origins in the design (System **Coordinate Origin**, **Relative Origin** and the **Design Centre**).

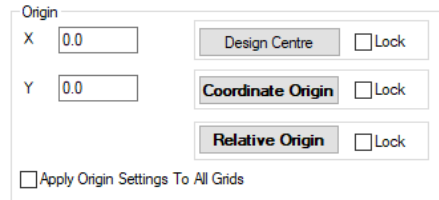

Grid Steps

The **Grid Step** dialog allows you to change the grid step setting in a simple dialog. As well as being available on the Setup menu, it is also accessible from the keyboard shortcut key <G>.

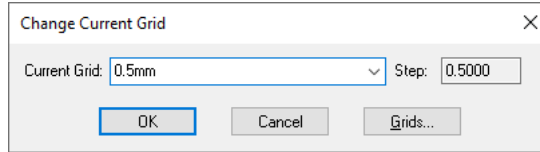

The **Grid Step** dialog presents the **Current Grid** name as defined in the **Grids** dialog, both system and user defined, and the grid **Step** value. The grid step value is always defined in your current units. To change the Working grid value quickly you can type <G 25> followed by <Enter>. This will change the working grid to 25 (Units).

Snapping to grid

When moving a design item, you can access the **Change Grid** option from the context menu.

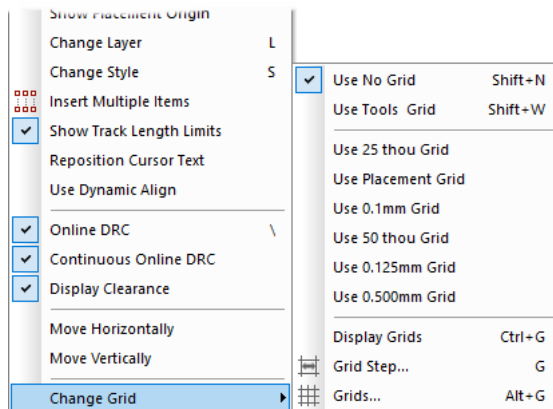

With the context menu you can change the grid of any item at any time. Any selected grid will be remembered for each type of item being subsequently move. For example, moving a Component on a 0.1mm Grid, the next time you move a Component, this grid step will be remembered.

Setting grid visibility

To set whether grids are displayed, you can use the **Grids** dialog or the keyboard shortcut key <Ctrl-G>. This will display all grids that have their **Grids Displayable** check box selected to on.

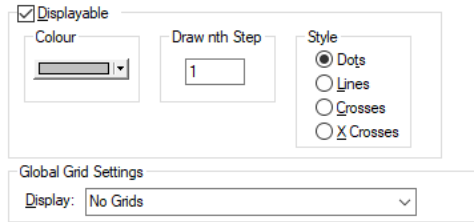

Any grids can be displayed but care should be taken if displaying more than two grids at a time as this can easily lead to confusion as to which grid is being shown.

You can change the display of the grid to draw any number of grid steps using the **Draw nth Step** box. This can be useful if the grid is only required every 10 grid points. The **Style** of the grid can also be changed between **Dots**, **Lines**, **Crosses** and **X Crosses**. A mix of each is also allowed for different displayed grids but the colours used should be chosen carefully.

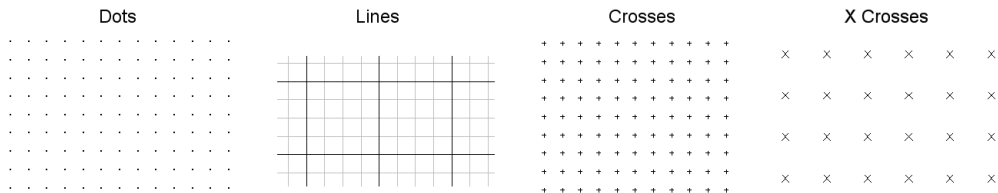

Snap Cursor To Grid

There is a check box option on the **Options** dialog and **General** page named **Snap Cursor to Grid**. Select this option to make the cursor move only on the current grid when in the design area.

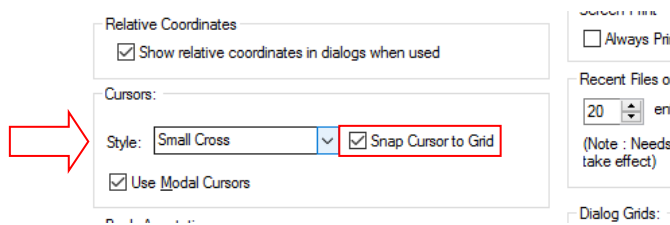

Gridded cursors will still be shown when modal cursors are displayed.

This option can only be used with the three cross cursors, it will not work with the standard windows cursor.

There is also a command available in the **Customise** option and **Keyboard** called **Toggle Cursor Gridding**. This can be used to quickly toggle snapping on and off.

Changing the Design Area Size

The design area is the area that you are allowed to work in. It is useful to have the ability to reduce the design size to be slightly larger than the maximum extents of the design. This makes the scroll bars more responsive and prevents you from 'losing' the design. Alternatively, if your design changes are to be larger than the design area then you may need to increase the size of the design area.

This is achieved using the **Design Settings** dialog from the **Setup** menu and the **Coordinate system** page.

Coordinate System Origin:
 (Offset from the lower left corner of the design area)

Design Area Size:

1 Inch

10 Inches

30 Inches

User Defined:

Show Relative Coordinates on the Status Bar

Relative Origin:

The **Design Area Size** can be created based on a number of predefined and user defined area choices as well as an automatic choice. The size relates to an area, so 10 inches for example, would be 10x10 inches from the 0,0 System Coordinate Origin point.

1 Inch (1 Centimetre), 10 Inches(10 Centimetres), 30 Inches (1 Metre). This changes depending on whether you have **Imperial** or **Metric** units selected. **User Defined** where you can specify the exact design area required. The **Fit** button will automatically size the design area to fit around the design. You are provided with a dialog to define the **Margin** around the design extents for which the design area is calculated, this is defined in the current design units.

Fit Design Area

Margin:

Once this has been defined the design area is calculated and is shown in the value box. Any changes made to the design area can be viewed in the **World View** window that shows you the maximum design area, the design and the current view of the design.

Changing the Design Origin

The Coordinate System Origin is the point from where all other co-ordinates are shown relative to. You may wish, for example, to show all coordinates relative to the centre of the design or board.

You have the ability to change the design origin in Pulsonix. The default is the bottom left hand corner of the working area.

Changing the Design Origin

If you wish to change the design origin you need to move the **Coordinate System Origin**. This can be done by using the **Design Settings** dialog from the **Setup** menu. You should type in the

coordinates of the new origin position required. The coordinates are defined as an offset to the lower left corner of the design area (0,0 origin).

Coordinate System Origin:
 (Offset from the lower left corner of the design area)

Design Area Size:

It can also be moved interactively by using the **Place Coordinate Origin** option on the context menu. To obtain this context menu, you should right click in free space in the design window.

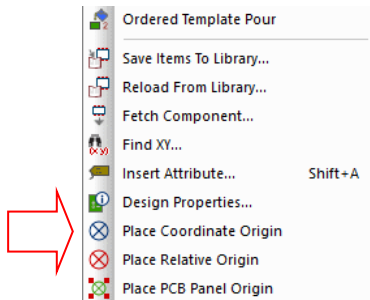

When the option is selected, you can drag the origin to its new location using the coordinates on the status bar to locate it.

If you wish to reset the origin back to 0,0, select the origin marker and click the **** key on the keyboard.

You cannot frame select any origins so you cannot accidentally move them. The **Coordinate System Origin** is locked by default so it cannot be accidentally moved. You can select and override the **Move** warning to perform the Move.

Working in Absolute and Relative Modes

Pulsonix allows you to work in both **Absolute** and **Relative** modes of operation.

Relative Mode gives you a means of temporarily reporting co-ordinates on the status bar relative to a defined point. This may be useful, for example, for positioning a group of components relative to a mounting hole.

Changing the Relative Coordinate origin

The **Relative Coordinate Origin** can be changed by typing in new co-ordinates using the **Technology, Design Settings** dialog. The **Relative Coordinates** are displayed on the **Status Bar** by selecting the check box, this also enables this mode.

User Defined:

Show Relative Coordinates on the Status Bar

Relative Origin:

You can also interactively move the Relative Coordinates origin by using the **Relative Origin At Cursor** command - shortcut keys **<Shift-X>**.

This will snap the origin marker to the current position of your cursor and the status bar will now display **Rel** for Relative Coordinates as well as displaying the coordinates relative to this origin.



When editing or moving items the status bar also displays the difference between the current item position and its previous point, shown as **dx:** and **dy:** values. This could be the last corner for a connection or track, or the position of a moved item relative to its start position. You can reset the Delta coordinates at any time by assigning a shortcut key to the **Reset Delta Coords** command. This can be used in context while moving an item.

The Relative Origin can be reset at any time or while in a 'mode' by pressing **<Shift-X>**. This will allow you to obtain a 'measured' distance while using an option if required, otherwise if left in one location all co-ordinates displayed will be relative to that point.

To differentiate this origin from the **System Co-ordinate Origin** marker you can change its colour in the **Colours** dialog under the **Others** tab.

If at any time you wish to go to the Relative co-ordinate origin in the design, you can click the **<X>** key on the keyboard. This shortcut key is set up by default for the **Find Relative Origin** command. This command is also available on the **Edit** menu under **Find** and **Find Relative Origin**. Once Find has been used, the Relative origin will be highlighted in the Highlight colour. You should use **Remove Highlights** to remove this colour. Remove Highlights is located on the **Edit** menu and on the context menu.

You can switch between the **Absolute** and **Relative** co-ordinate modes by using the **Relative Mode** command - shortcut key **<Shift-R>**, this will toggle between the two modes using the previous Relative Origin point set and the Absolute co-ordinate origin.

Technology Files

Technology files are like the template files used in other general office products. They are a way of constraining a design to a specific set of predefined rules or parameters. They are also a quick method of starting designs based on known characteristics, from defined rule sets or previous designs. This makes it easier to obtain consistency between designs.

A default set of Technology files have been supplied with Pulsonix that can be used and edited by you to match your own requirements. Any technology file name selected will be taken from the default Technology File folders defined in the **Folders** option.

There are a number of options that allow you to load technology files as part of their process; anything that is started from new can be started with a Technology file, PCB design or Schematic design for example. Any library creation or editing of library contents, including the Symbol creation wizards, and also the **Translate To PCB** option.

Schematics and PCB both have their own technology files and cannot share information between them. For example '4 layer.ptf' (the supplied 4 layer PCB technology file example) can be used on both PCB footprint libraries and the PCB design, but not for Schematics.

It is advisable to use Technology files, although this isn't necessary because Pulsonix adds styles etc. when no match can be found when adding components for example.

This section covers the concept of Technology files and the Technology dialog, each facet to the Technology file is described in more detail as each option is shown as you move through this manual. There are some special items of the Technology file that have been selected for more attention in this section.

The contents of Technology files

The list below shows the items that make up the contents of Technology files:

- All Technology dialog information (Spacing Rules, DFM/DFT Rules, Attributes, Net Names etc.)
- Technology dialog Style and Style Naming rules
- Technology dialog High Speed rules
- Design Setting options including Defaults (but not Options dialog settings)
- Grids
- Units
- Colours
- CAM Plot output settings including Drill Sizes
- Variants
- Autoplace, Autorouter, Auto Gate & Pin Swap and Auto-Mitre parameters
- DXF output dialog settings

Creating and saving Technology files

Technology files can be created as a stand-alone process to set these files up, or can be extracted from existing designs, for example from a Schematic design. Technology files do not hold all the design information, they only hold a sub-set containing items such as styles, rules, colours, grids and units etc.

If creating a brand new Technology file you can use the **New** option on the **File** menu, use the **Technologies & Profiles** tab. If you wish to base your new file on an **existing** technology file you can select a **Technology** file by name provided it exists in the Technology file folder defined in the **Folders** option. For example, you may well be creating an 8 layer Technology file by starting with a 4 layer file and adding another 4 more layers.

You can also create a Technology file by extracting technology data from an existing design.

You can **save** technology files from within all design editor or library editor options except the Parts Editor. The **File** menu contains the **Save Technology** option from where you can save technology file information.

When editing a technology file, you should use the **Save Technology** option to save a technology file to the correct folder.

Introduction to the Technology dialog

Accessed from the **Technology** option on the **Setup** menu, the Technology dialog is used to manage the Styles and Rules of the design. Although it does not contain all of the technology file contents, the Technology dialog does make up many of the most important facets of the Technology file. Each of the tabs on the Technology dialog will be discussed in more detail as they are used throughout this manual. The example dialog shown below is for **Attribute Names** in a **PCB technology**:

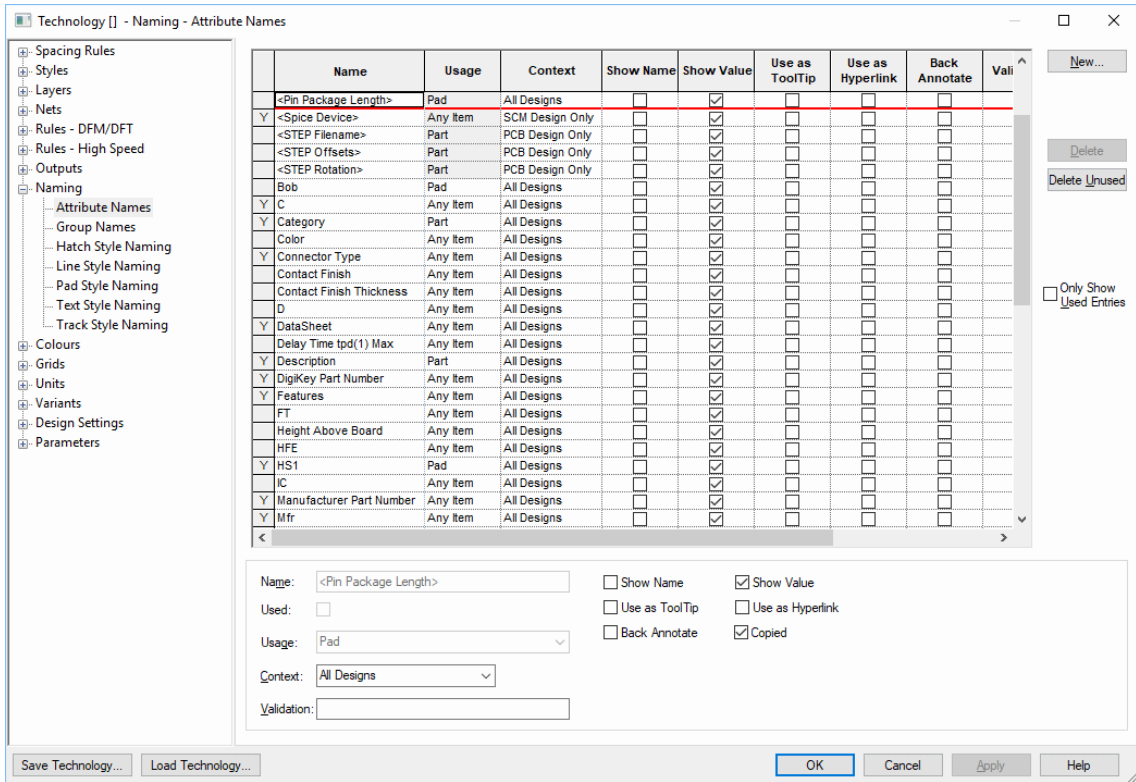

As you will note, there are differences between each type of Technology dialog. The Schematic Technology dialog contains Styles entries mainly and some pre-defined names for Nets or Attributes. Whereas the PCB Technology dialog also contains Styles for the 'physical' items within the design, such as Pads, Tracks, Spacing Rules, DFM/DFT Rules and Layers etc. as well as the CAM Plot outputs. Part Technology files contain a minimal set of Technology is used for setting up pre-defined signal names and attribute names when creating or editing Parts.

Styles

Styles are used to define how an item will look when displayed in the design. For example, how thick a line should be, or what shape a pad is and what drill size it contains.

By giving an item or items a style, you can define a group of similar items and give them the same look, but also be able to change their look by simply editing one corresponding value on the Styles page. This means that through the **Line Style** tab on the **Technology** dialog you could assign a **Line Style** of **Symbol Outlines** the **Width** of 6 (thou, defined in current units) to all the Component outlines used in the design (the style being assigned during the Symbol creation process). This would be a **global** style for all items that use this same style in the design.

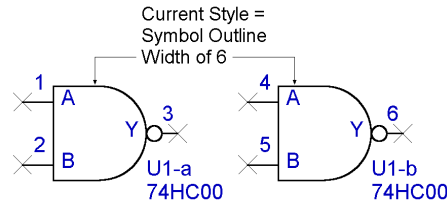

This could then be changed to **10** thou by editing only the value on the **Line Style** tab again.

You can also have **local** styles that are specific styles that only appear on one item. This means the system is flexible enough to allow small local changes to be made, but also powerful enough to allow changes throughout the design to be made.

Introduction to Net Items

Within the **Technology**, there are pages in the **Nets** section for defining facets that are properties of a net or multiple nets, Signal Paths, Sub-Nets, Differential Pairs and Chains of Differential Pairs. Each of these net items can have attributes assigned and rules added to them.

Why and when to use each category

To summarise each category, here is what they are used for in Pulsonix:

Standard net items

Nets – All Nets (Connections) within the design have a **Net Name** with a **Type** (*see special note below about Type*) and (optionally) a **Guard Space**. They can also have a set of attributes containing rules added, for example, a **Track Length Rule**. They can also have an optional **Net Class** associated with them. Net Names can be user defined or default names automatically assigned by Pulsonix.

Net Class – Net Classes have a **Net Class Name**, a **Type** and a flag to **Mark All Nets As One**. It also contains Net Class based **Track Length Rules**. A Net Class is an alternative method of ‘grouping’ nets to which the same parameters can be associated. This is a general method for grouping categories of nets but can be achieved more efficiently using alternative methods. Nets do not require a Net Class now, all rules can be attached to a single net or multiple nets.

Net Styles – All default [physical] styles (Tracks, Vias etc.) associated with a Net Class or Net Attribute are defined in the **Net Styles** dialog. This dialog is also used to define how tracking will behave on different **Layers**, within **Areas** and for **Layer Spans**.

Net items for the High Speed Design Option

Signal Paths – Signal Paths represent another level of net definition. The path is a named item containing an ordered list of pads that represent a signal path. You might use this within High-Speed designs for example where constraints are required. This could be where the overall track length of the signal path would require a specific defined length rule(s).

Sub Net – These define part of a net which may require special considerations. These are defined in the **Sub Nets** dialog using an **attribute name** and **value**. Pins on the same net with attributes that match it are deemed to be in the same sub net. One definition can define sub nets in multiple nets. You may use this for example, when creating branch lengths or a specific daisy chain order in a High Speed design.

Differential Pairs – The Differential Pairs dialog is used to define the Differential Pin Pairs and Differential Pair Chains (see below). All other Differential Pair specific rules such as **Pair Gap** and **Pair Length** are contained in their own dialog under the **Rules – High Speed** section.

Differential Pair Chain – A Differential Pair Chain is two or more (existing) Differential Pairs added to a named list to create an extended list. This is used for associating multiple Differential Pairs so that lengths or net rules can be defined for the overall ‘path’. This path may be split with a terminating component for example and will contain different net names. As with Differential Pairs, a design can contain multiple Differential Pair Chains.

Type – a net always has a Type, this is assigned when the net is introduced to the design. It can be one of three states; Power, Ground or Signal. Type is used for some net-based options such as Optimise, Design Rules Checks, ERC and Autoplace.

Net Styles

Net Styles provide a means of defining the default track and via styles to be used when routing PCB designs.

Net styles enables you to achieve the following:

- Use wildcard characters in the net class name to reduce the number of duplicate default style definitions.
- Define different default track styles for layers and areas.
- Define different default via styles to be used for each layer span.
- Define different default track and via styles to be used within specific areas.

You may use the Net Styles dialog to create sophisticated rules on a per-layer or per area basis for example.

Enable	Attribute Name	Match Value	Net Type	Area	Track Styles			Via Styles				
					Track Side	Track Layer	Def. Track	Alt. Track	Fat/Neck Min Len	Via Span	Via Style	Via Protected
<input checked="" type="checkbox"/>	<Net Name>	ADD*					Track (6)	Track (8)	<Default>			
<input checked="" type="checkbox"/>	<Net Name>	Diff*		Inner			Track (8)	Track (10)	<Default>		Via (40)	
<input checked="" type="checkbox"/>	<Net Name>	Diff*					Track (10)	Track (8)	<Default>		Via (40)	

Attribute: <Net Name> For Nets of Type: <Any>

Match: Diff* Within Areas: []

Define Default Track Styles

For Tracks:

On Side: Inner

or

On Layer: []

Default Track Style:

Name: Track (8)

Width: 0.203+

Alternate Track Style:

Name: Track (10)

Width: 0.254

Fatten/Neck Min Length: <Default>

Define Via Defaults

For Vias with Layer Span: <Any>

Vias Not Allowed

Define Via Protection: Delete if not Routed Reduce Span

Define Default Via Style

Name: Via (40)

Width: 1.016 Shape: Round

Length: 1.016 Drill: 0.610-

Plated

Rules

What is a rule?

A rule is a collection of specific conditions and characteristics that can be assigned to a net. Whereas previously these rules were bundled to be set on Net Classes, they are now individual facets that can be assigned to any net or sets of nets. Rules are attribute driven. Some ‘rules’ are system ‘attributes’ such as <Net Name>, <Net Class> etc. but user defined attributes can be added as well.

User defined attributes would be created when system attributes do not provide enough range for rules coverage. For example, a Track Length rule might be applied to multiple net names that do not have a common name format, like CLK, RST, DQ1, ADD3 etc.

What characteristic might a rule have?

Rules can be standard items such as Copper Pour, Thermal connectivity, Teardrops and Net Styles etc. More advanced rules might include facets such as Track Length, Track Length Match, Serpentine and Track RF features so mention a few.

What can a rule be assigned to?

Rules can be assigned to any Net, Signal Path, Sub-Net, Differential Pair and Differential Pair Chain. This means one (or multiple) rules can be applied to multiple net categories. For example, a number of Thermal rules can be defined and applied to all signal or power style nets. Likewise, a Track Length Match rule can be applied to multiple sets of Differential Pairs to ensure they are all within length difference of each other.

Rules may also still be assigned to a Net Class if required but with this style of rules structure is less likely to be used this way.

In addition to assigning rules to Net items, in the Thermal Rules and Teardrop Rules dialogs, you can also assign rules to <Pad Style Name>. This means specific rules can be added for pad or via styles for ranges or specific pads.

Key headers used in the rules dialog

There are some essential headers that are used within the rules dialogs and are highlighted below:

Attribute Name	Match Value	Total Track Length		Max Vias	For Nets and Subnets Apply Rule To	
		Minimum	Maximum		Total Track Length	Pin To Pin Track Length
TrackLengthRule	1000-1500	20.00000	28.00000	2	<input type="checkbox"/>	<input checked="" type="checkbox"/>

Attribute Name – this is the name of attribute that will define the rule, for example, this could be one of the system ‘attributes’ such as <Net Name> or <Net Class Name>, or it could be your own user-defined attribute name, such as TrackLengthRule

Match Value – once an Attribute Name has been defined, you must give it the name of something to match. This could be a unique Net Name, CLK for example, or a range of Net Names to apply the rule to, such as ADD0 to ADD9. Using Ranges to match the attribute means a single rule can be applied to multiple instances.

Creating and applying Rules

Rules can be created and applied using two methods:

Method 1

Create your rules first in the Rules sections (in the Technology dialog under DFM/DFT and High Speed) and apply them to the net(s) required.

As an example, we'll show the addition of a **Track Length Rule** but the principle applies to all rules. Create the rule by adding an **Attribute Name** and **Match Value**, plus your rule **values**:

Attribute Name	Match Value	Total Track Length		Max Vias	For Nets and Subnets Apply Rule To	
		Minimum	Maximum		Total Track Length	Pin To Pin Track Length
<Net Name>	ADD*	15.00000	81.00000	2	<input type="checkbox"/>	<input checked="" type="checkbox"/>
<Net Name>	ALARM	33.00000	44.00000	2	<input type="checkbox"/>	<input checked="" type="checkbox"/>

On the **Nets** page, if the new attribute matches the rule, the attribute name and value will be automatically adopted. If the rule doesn't match automatically, apply the rule by typing the rule name in the **Attribute** field (or selecting it from the drop down list which will be populated from the list of available rules).

The example below is specific to the **Track Length** rule as this is directly shown in the **Nets** dialog:

	Name	Net Class	Type	Guard Space	Check Same Net	Track Length Rule			
						Attribute	Match	Minimum	Maximum
Y	A	Signal	Signal	0.00000	<input type="checkbox"/>				
Y	ADD1	Sig2	Signal	0.00000	<input type="checkbox"/>	<Net Name>	ADD*	15.00000	81.00000
Y	ADD2	Sig2	Signal	0.00000	<input type="checkbox"/>	<Net Name>	ADD*	15.00000	81.00000
Y	ADD3	Sig2	Signal	0.00000	<input type="checkbox"/>	<Net Name>	ADD*	15.00000	81.00000
Y	ADD4	Sig2	Signal	0.00000	<input type="checkbox"/>	<Net Name>	ADD*	15.00000	81.00000
Y	ADD5	Sig2	Signal	0.00000	<input type="checkbox"/>	<Net Name>	ADD*	15.00000	81.00000
Y	ADD6	Sig2	Signal	0.00000	<input type="checkbox"/>	<Net Name>	ADD*	15.00000	81.00000
	AR_D	Signal	Signal	0.00000	<input type="checkbox"/>				
	ALARM	Signal	Signal	0.00000	<input type="checkbox"/>	<Net Name>	ALARM	33.00000	44.00000
	AXIS2		Signal	0.00000	<input type="checkbox"/>				
	AXIS3		Signal	0.00000	<input type="checkbox"/>				
Y	B	Signal	Signal	0.00000	<input type="checkbox"/>				
	hsh	Signal	Signal	0.00000	<input type="checkbox"/>				

All rules added to a net-based item are displayed in the relevant dialog in the **Rules** and **Attributes** tabs:

Name: HS

Used:

Net Class: HS

Type: Signal

Check between items on same net:

Guard: 0.00000

Rules Attributes

Track Length Rules: <Net Class Name>=HS [Min: 5.08000 Max: 81.28000]
 Track Match Rules: <Net Class Name>=HS [Max Diff: 12.70000]

Net Styles: <Net Class Name>=HS Track Side: 'All' . Via on any Layer Span [Tr

Layer Change Length Rules: None
 Copper Pour Rules: <Net Class Name>=* [Min Island: 1.61290 Remove Isolate
 Necked Length Rules: None
 Serpentine Rules: <Net Class Name>=HS [Amplitude Min: 3.17500 Max: 6.3500
 Teardrop Rules: <Net Class Name>=* [Shape: Teardrop V: Angle: 60 R: Angle: Tr

Method 2 – Track Length Rule & Track Length Match Rule

When using the **Track Length Rule & Track Length Match Rules**, an alternative is to write the rule directly into the dialog that requires it (Net Name, Net Classes, Signal Paths and Sub Nets). Once the attribute (Rule) is written, it then becomes a rule within its own right and appears in the relevant Rules page where it is available for use on other nets.

To do this: in the **Nets** dialog, write the rule into the **Attribute** cell along with the **Match** and **Values** to be used. In the example below, the <Net Name> system attribute has been selected. The typed Match will be FB0?. And values of 22.0 and 27.0 for Min and Max Track Lengths respectively. This then matches the Net names FB01-04 but not FB011 (? will only match one character).

	Name	Net Class	Type	Guard Space	Check Same Net	Track Length Rule			
						Attribute	Match	Minimum	Maximum
Y	FAT	Signal	Signal	0.00000	<input type="checkbox"/>				
Y	FB01	Signal	Signal	0.00000	<input type="checkbox"/>	<Net Name> FB0?		22.00000	27.00000
Y	FB02	Signal	Signal	0.00000	<input type="checkbox"/>	<Net Name> FB0?		22.00000	27.00000
Y	FB03	Signal	Signal	0.00000	<input type="checkbox"/>	<Net Name> FB0?		22.00000	27.00000
Y	FB04	Signal	Signal	0.00000	<input type="checkbox"/>	<Net Name> FB0?		22.00000	27.00000
	FB011	Signal	Signal	0.00000	<input type="checkbox"/>				
	Gnd	Power	Power	0.00000	<input type="checkbox"/>				

Using Attribute Rules

Once Attribute Rules have been defined, they can be matched on a net item by Rule Value or by Rule Name depending on which scheme best matches your requirements.

Match the rule value - any item with the rule attached and matching the value. For example Attribute Name=TrackLength, Match Value=2.0. Where a net then contains an attribute of TrackLength and a Matched Value of 2.0, the rule will be applied.

Match the rule name - any item with the rule attached, with no value (%# must be used as the value to show a field with no value), but match by rule (attribute) name.

Rule Matching Examples

Wildcards are a powerful way to create ranges for selection, below shows a selection of wildcard ranges:

Attribute Name (Rule)	Match Value	Rule Values	Description
<Net Class>	Signal	xx	A specific Net Class name of Signal has the rule applied (where xx is your rule value)
<Net Name>	DQS*	xx	Any net starting with DQS
<Net Name>	DQS*[1:7%]	xx	Any net between DQS1 to DQS7
<Differential Pair Name>	%{DQS* DSM*%}	xx	Any Diff Pair starting with either DQS or DSM will have the rule applied. The strings are separated by a pipe () character.
TrackLength	2.0	xx	Any net that has the attribute with the name TrackLength matching a value of 2.0 will have the rule applied.
TrackLength	Blank (will be written as %#)	xx	Any net with the attribute name TrackLength with no value will have the rule applied.

Wildcard Wizard

When a wildcard needs to be defined to create name ranges, you can use the **Wildcard Wizard**. This allows you to create wildcards, often, complex wildcard strings (or simple ones), that are presented in non-programming terms.

On dialogs where wildcards are accepted, there is a button to access the wizard.

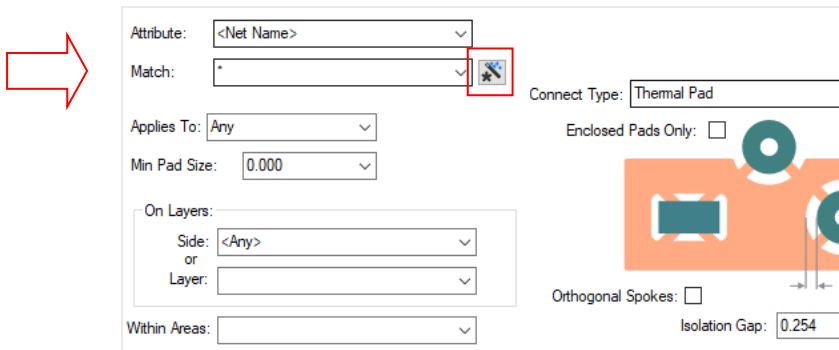

Pressing the button opens up the **Wildcard Wizard** dialog:

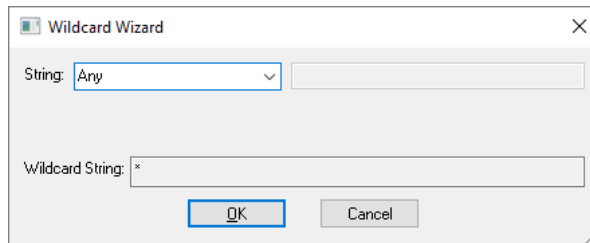

Wildcard String expressions are defined from the drop down list:

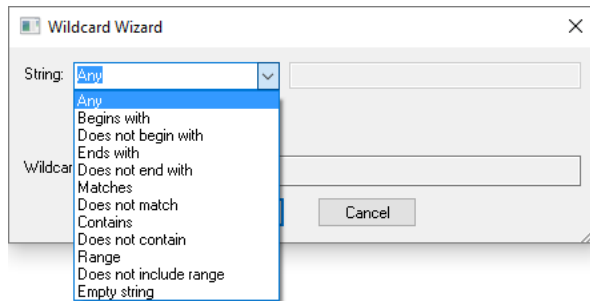

On selection of a **String**, you can type in the value to match. The **Wildcard String** is shown in the Wizard dialog.



When **OK** is pressed, the wildcard string is shown as the **Match** value back in the host dialog.

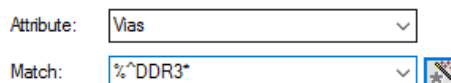

Colours

Pulsonix provides a powerful colours mechanism that enables you to configure the colour, selectability and true width of each design item type to suite your own preferences. The **Colours** dialog is accessed from the **Setup** menu.

The specifics of each tab on the **Colours** dialog will be discussed as they are used in each chapter, this chapter introduces the Colours dialog. The dialog's use and feel are the same throughout Pulsonix, the main differences being the contents for each application type.

Using the Colours dialog

The **Displayed** and **Selectable** check boxes will set whether items in the design can be seen, and whether they can be selected. Items that cannot be seen in the design cannot be selected, even when using the **Frame Select** mode.

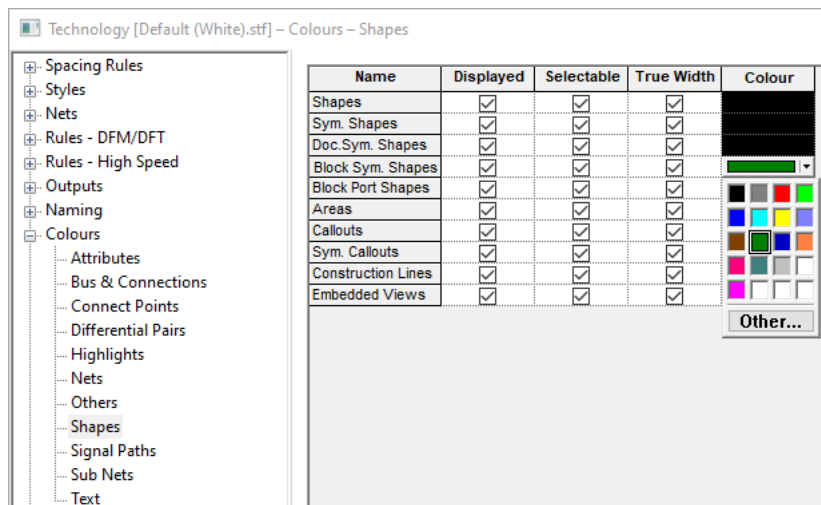

To **change a colour**, you select the cell that you wish to change. A drop down colour palette will appear. On selecting the colour, the cell will change and the palette disappears.

If the colour required does not appear in the standard 20 colour palette, you can use the **Other** button to display the standard Windows colours palette to create the colour required. The bottom row of the drop down colours palette will display the most recent colours used.

Once a **colour** is set for a cell, that colour can be applied to a row or column by selecting the **Apply to entire Row/Column** option from the context menu.

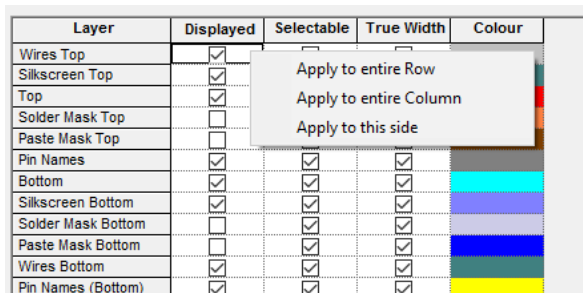

This method of applying to entire Rows or Columns is the same for the **Displayed** and **Selectable** check boxes. Any selections made in these check boxes can also be applied to each Row or Column using the context menu.

The main differences between the Schematic and PCB Colour dialogs is that the PCB dialog is 'layers' based, whereas the Schematic is 'flat'.

Loading new Colour Schemes

Complete Colour schemes can be loaded using the **Load Colours** from the **Colours** dialog, the **Load Colours** option from the **Setup** menu and from the **Colour Files Bar**.

All files listed have been found in the search path setup in the **Setup, folders** option.

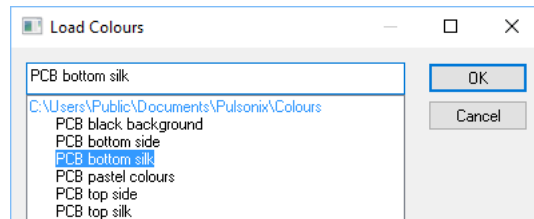

Colours are an integral element within the Technology File and as such can also be loaded as part of this file. During **Load Technology**, you can select to only load the Colour elements of the design, ignoring any other elements. This enables you to load or reload the Display flag of any item(s), or the Selectability, or the Colour of an item(s) within the design.

Changing the Colours in Properties

There are some colour items that can be changed independently of the Colours dialog, e.g. Documentation Shapes and Text. Generally, these items can be changed in the **Item Properties** dialog for each item. When available, the **Own Colour** check box will be enabled and the local colour can be changed. The example dialog below shows a Doc Shape **Properties** dialog:

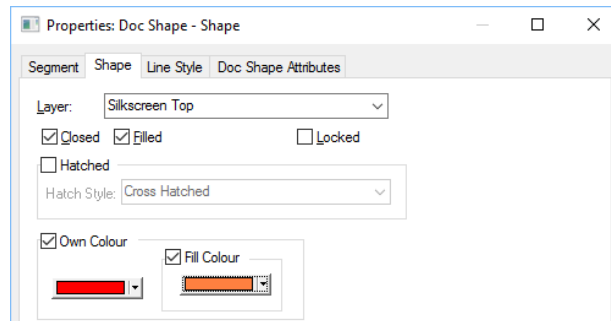

Load Technology

The **Load Technology** option is used to load or reload, all or part of an existing Technology file contents into the current design. You should use this if your current design does not contain technology elements that appear in another technology file. For example, a double sided PCB design may need to be increased to 4 or 6 layers, these additional layers can be loaded using this option (a simple example, obviously you could just add the extra layers quickly anyway!).

Once loaded and a new mix of technology files obtained, this 'set' of elements can be **Saved** to another new Technology filename for use on another design. Use the **Save Technology File** option from the **File** menu to do this.

You can only use Technology files that are relevant to that design type, Schematics Technology files can only be used in the Schematics designs and not in the PCB designs etc.

Using the Load Technology dialog

The dialog is run from the **Setup** menu, using the **Load Technology** option.

You select the **Technology File** to load from the drop down list, choose the **Technology Elements** to apply and start the process using **Load**. You are able to choose not to load items that don't already exist in the design or to load them if they are required using the **Add if not already in the design** check box.

Below shows the **Load Technology** dialog used when editing a Schematic design:

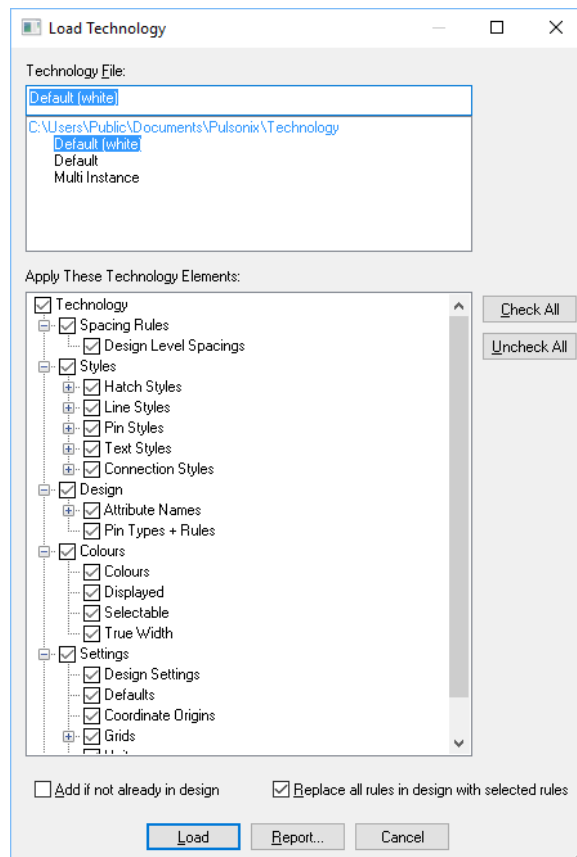

The **Check All** and **Uncheck All** buttons are used to make complete selections of the Elements check boxes. Quite often, it is easier to use the Check All button and deselect the items not required, or vice versa.

The **Report** button will generate a report for you containing a list of all the technology items that will be updated in the design when the Load button is pressed.

Profile Files

Profile files are files that can be loaded to create a design or to add to a design. They can contain drawing blanks, page borders and title blocks or the board outline (in PCB), Component pre-placement and assembly information (in PCB).

Profile Files can be used to load predefined 'documentation' information into a design. They differ from Technology files in that they only contain the documentation information rather than rules, styles, colours etc.

Profiles files combined with Technology files can provide a giant step into getting a design started quickly, especially if using an existing set of files created from previous designs that may be similar. Using these files you can combine design facets from different designs, and even designs from different systems once imported.

By default, the supplied Profile files are installed into the folder, **Pulsonix\Profiles**. This location can be changed or additional folders included using the **Folders** option and **Profile Files** dialog.

Schematic Profile Files or Drawing Profiles

Schematic Profile Files are actually called **Drawing Profiles**. They are normally used for drawing blanks and title blocks, rather than to predefine design information that is how PCB Profile Files are normally used.

All Profile items that appear on *Page 1* of the design and items marked as **Common to All Pages** will appear on other pages as well.

PCB Profile Files

Board Profiles are stand-alone design files that contain data describing standard board types that you can use as a starting point when designing a PCB board of that type.

They contain a board outline that has the shape and size required for manufacturing rather than just describing the outer edge of the board as an indicator. Pulsonix profiles also contain mounting holes, documentation and annotation required to manufacture the finished board.

Loading Profile Files

Once created, Profile files would normally be loaded when creating a new design but you can still load one using the **Load Profile** or the **Load Drawing Profile** options from the **Setup** menu. They are the same options for both Schematic and PCB editors but are named slightly differently. The Profiles can be loaded into a design the same as any other design item.

When a PCB already contains a board profile and Load Profile is used, the old board will be replaced for the new one (board and associated Component pre-placement). This is the same principle for Schematic Drawing Profiles, one is replaced the new one being added.

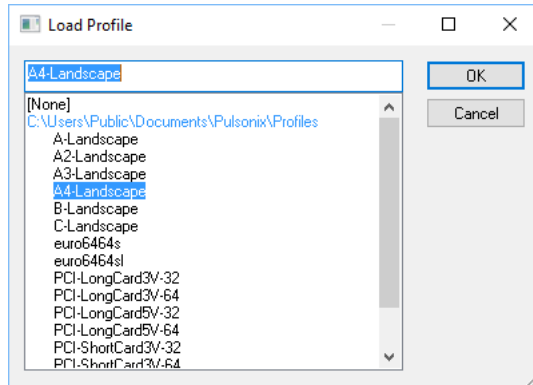

You can also use other options to pre-load the Profile files during the initial design creation process. You can use **New - Schematic** and **PCB Design**, and **Translate To PCB** from within the Schematic design editor.

Creating and Saving Profile files

Profile can be created as a stand-alone process (from new) or can be extracted from existing designs by saving items from to a Profile file. Not all of the design can be saved to a Profile file but the program will save what is required. Use the **Save Profile** option from the **Setup** menu to do this.

If creating a brand new profile you can use the **New** option on the **File** menu, use the **Technologies & Profiles** tab. If you wish to base your new Profile on an existing profile you can select it by picking it by name provided from the list.

If using an existing design, when you use **Save Profile** in the PCB design editor, you are presented with a dialog from where to choose the Component name(s) to save into the file. Once the names are selected, you are presented with the standard **Save** dialog in which to enter the location and filename of the file.

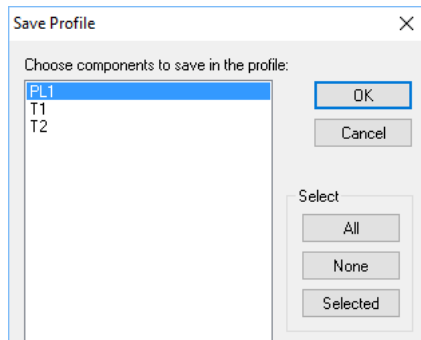

Design Defaults

When adding new items to a design (schematic or PCB) and to create symbols, the option being used will take styles and layers etc. from a central source. This source is defined as part of your Technology and is loaded when you use a Technology file on a new design.

All of these defaults are stored in the **Technology, Design Settings** dialog on the **Settings** menu. Within this dialog are the **Default** pages. The example below shows the **Bus** defaults used in the Schematic editor. Schematic and PCB defaults are different in that they contain different entities.

Line Style:

Name Style:

Bus Terminal Offset:

Bus Terminal Direction:

Up (on vertical bus segments)

Right (on horizontal bus segments)

In Dialogs - Apply Styles to All Connected or Same Name Busses

Working With Attributes

What is an Attribute?

An attribute is textual information attached to an item in the design, or to the design itself. This information can be provided by the system e.g. **Last Saved Date**, or entered by you. Some attributes are automatically added to items by the system e.g. **Pin Names**, others are inserted by yourself. Attributes can be optionally displayed and plotted, or hidden away to be used later in reports or outputs to drive third party tools.

An attribute can also be attached to a net to provide a mechanism for which to associate particular rules created within the **Technology** file, such as Thermal Rules, Copper Pour rules, Teardrop Rules, or in the case where the High Speed option is available, high speed rules such as Track Length Rules or Serpentine Rules.

An attribute has the following properties:

- Attribute Name – Attributes provided by the system are identified by having angled brackets around them e.g. <Part Name>. All attribute names provided by you are collated together and presented in the Technology dialog. These names are also presented in a list when adding attributes, to make it easier to add common attributes to different items. If you have some attributes that are always used in your designs it is a good practice to add these names to your Technology files so they are always available when creating new PCB, Schematics or Part designs.

You can make attribute names specific to certain types of item setting the Usage parameter. For example, a name can have usage Pin that means it can only be added to Component pins e.g. Pin Order.

In the Colours Dialog you can set up each attribute name's colour, whether they are displayed and, if displayed, whether they are selectable. This is a quick way of altering the appearance of all attributes using the same name.

Name	Displayed	Selectable	True Width	Colour
<Block Author>	<input checked="" type="checkbox"/>	<input checked="" type="checkbox"/>	<input checked="" type="checkbox"/>	Green
<Block Description>	<input checked="" type="checkbox"/>	<input checked="" type="checkbox"/>	<input checked="" type="checkbox"/>	
<Block Instance Name>	<input checked="" type="checkbox"/>	<input checked="" type="checkbox"/>	<input checked="" type="checkbox"/>	
<Block Name>	<input checked="" type="checkbox"/>	<input checked="" type="checkbox"/>	<input checked="" type="checkbox"/>	
<Block Original Name>	<input checked="" type="checkbox"/>	<input checked="" type="checkbox"/>	<input checked="" type="checkbox"/>	
<Branch Point Name>	<input checked="" type="checkbox"/>	<input checked="" type="checkbox"/>	<input checked="" type="checkbox"/>	Blue
<Component Height>	<input checked="" type="checkbox"/>	<input checked="" type="checkbox"/>	<input checked="" type="checkbox"/>	
<Component Name>	<input checked="" type="checkbox"/>	<input checked="" type="checkbox"/>	<input checked="" type="checkbox"/>	
<Component Variant Id>	<input checked="" type="checkbox"/>	<input checked="" type="checkbox"/>	<input checked="" type="checkbox"/>	
<Current Variant Description>	<input checked="" type="checkbox"/>	<input checked="" type="checkbox"/>	<input checked="" type="checkbox"/>	

- Attribute Value – This is a text string either supplied by the system e.g. Date '12/3/99', or supplied by you indirectly when performing certain operations e.g. Component Name 'U1' or inserted by you directly when adding an attribute e.g. Part Value '2K'. The value can be left blank if the attribute is only being used to 'mark' an item.

- **Attribute Position** – Each attribute is capable of having its value string displayed in the design. The visible attribute is known as an ‘attribute position’. When displayed you can move, rotate, and mirror the attribute position, and allocate its text style and layer (if in a PCB design). An attribute can have more than one attribute position, to display it on more than one layer for example.
- **Owner** – Every attribute is attached to an owner item. This can be an item within a design, an item within a footprint or part, or attached to the design, footprint or part itself. Attributes cannot be attached to Text, other Attributes, Connections, Tracks, Dimensions or Origins. Moving a displayed attribute will highlight its owner.

System Attributes

System attribute names are predefined as they represent information that is provided from the system or from data already within the design.

These system attribute names are not presented in the **Technology** dialog, but can be used to add attribute positions to items in order to display the relevant information.

The system attribute information, or value, is added to items during the various stages of their creation, and can be ultimately displayed on the owner item. On some of these attributes, you can make them displayed and define their attribute position before the value has been provided.

An example of this is the **<Component Name>** attribute. This is the reference name of the Component when added to the design e.g. **IC44** or **R21**. When using this attribute in the Schematic design, it can also be used to identify individual Gates if setup in the **Design Settings** dialog under **Naming**. This attribute can be initially added and positioned within the footprint library item. Because the value is only added when the footprint is added to a PCB design, it is displayed in the footprint as an ‘unsatisfied attribute position’, also known as an ‘attribute place holder’. It is drawn as the attribute name enclosed within curly brackets e.g. {<Component Name>}.



As soon as the Component is added to the PCB design and assigned the name '**IC44**', the visible attribute position is changed to the correct value.

User Defined Attributes

In addition to the system provided attribute names you can add your own. These can be added directly through the **Technology** dialog so that they are available for use when adding attributes later, or they can be created whilst inserting attributes.

When adding attribute names to the **Technology** dialog you should use the **Attribute Names** tab:

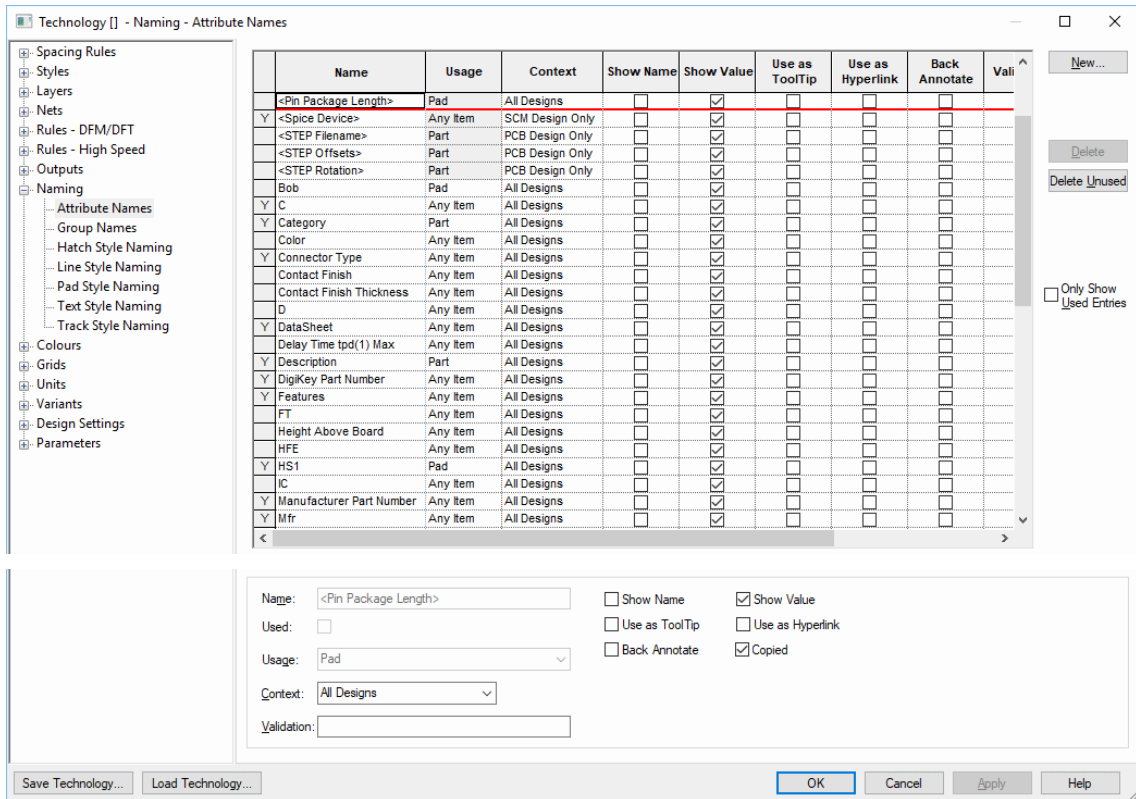

Attribute names and values can be selected for display using the **Technology** dialog and **Attribute Names**. You can choose to display the attribute **Name (Show Name)** or **Value (Show Value)**.

Your own attributes can be added to items in the design using one of the following options:

- **Insert Attribute**, this is used to attach and attribute name and value to an item.
- **Insert Attribute Position**, this is used to attach an attribute name to an item. The value would then be populated at a later point. For example, on a resistor, Value might be ?. When used in the design, this would be edited to provide a 'real' value, such as 10K

Both features are defined below:

Insert Attribute

Use the **Insert Attribute** option from the **Insert Menu** to add an attribute to an item by picking it in the design, then choosing or typing an attribute name and typing an attribute value. This allows you to interactively place the attribute position, choosing its style and layer as well.

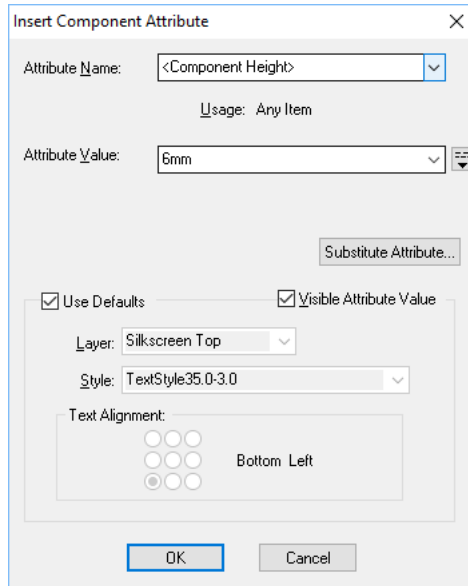

Add Attribute To - Only provided if a design item was NOT pre-selected. Use to specify the type of item you are adding the attribute to. This makes it easier to pick the item and restricts the list of attribute names you can use. Choose **Design** to add design level attributes.

Attribute Name – Type in your own new name, or pick from a list of system attribute names or attribute names already added to the system.

Attribute Value – Type the value for the attribute and choose whether it is to be visible. If this is a system attribute, this field is disabled and the value provided by the system is displayed.

Use Defaults – Check this box if you wish to use the Attribute defaults defined in the **Design Settings** dialog under **Attributes**. If you wish to override them with local attribute settings, uncheck the box and define your own.

Adding the Attribute

If no item was pre-selected and you are not adding the attribute at design level, you will enter a 'picking' phase to choose the item to add the attribute to.



When **Insert Attribute** is used with an attribute that can be attached to multiple items a modal cursor is displayed.

If the attribute is visible you will enter a phase enabling you to manually place the attribute position.

Insert Attribute Position

The **Insert Attribute Position** option offers the same functionality as **Insert Attribute** except it is only used for placing the attribute. The attribute value cannot be typed, so it's only really used making existing attributes visible, or adding a 'place holder' attribute position on items that do not as yet, have the attribute value, but want it to be positioned and visible when it is added later.

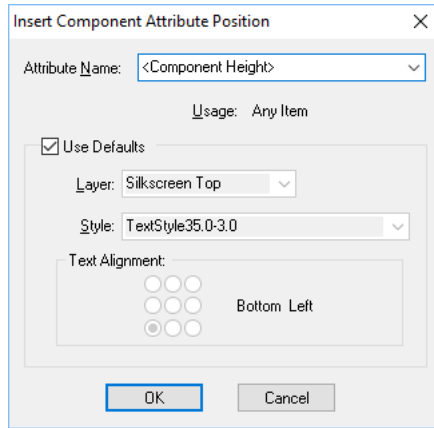

This is used mainly in PCB Footprints and Schematics Symbols to add place holders for items like Part Names, Values, Pin Names etc. where you want a specific position to be used. The attribute values are fulfilled from the Part and 'applied' to the attribute positions when the Part and Symbol/Footprint are added to a design as a Component.

Properties

Properties can be used from the context menu once an item is selected. Choose the attributes tab applicable to that item, for example if picking a Component Pad on a net, you have a **Pad Attributes** tab, a **Component Attributes** tab and a **Net Attributes** tab. This example shows the **Comp Attributes** tab after picking a Component.

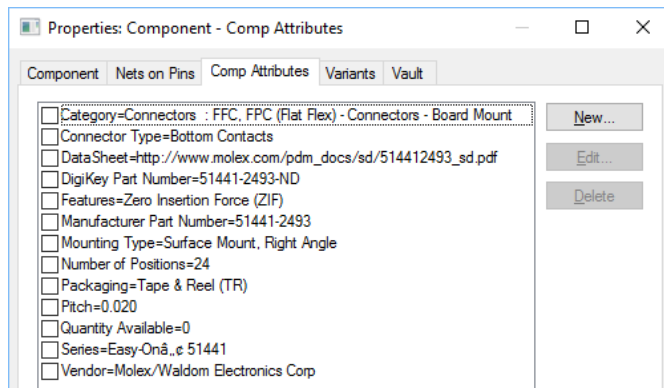

The list shows all current attributes on the item, and whether they are currently displayed. Use the **New...** button to add a new attribute to the item selected.

Design Properties

The **Design Properties** option has a similar interaction to the **Properties** option, but available on the **Edit** menu. Use the **Attributes** tab to add design level attributes.

Part Attributes in the Part Editor

You can insert Part level attributes within the Parts dialog on each of the pages using an interactive method or by using the **Part Attribute Editor** (this is discussed later on in this section).

Attributes		
Part Name	Manually Name Parts	1008CS-100XGLC
Attributes	Mfr	Coilcraft
	L	10nH
	Freq	50MHz
	TOL	2%
	Qmin	50@500MHz
	SRFmin	4100MHz
	DCRmax	0.08
	Irms	1000mA
	<Hyperlink>	www.coilcraft.com
	<Component Height>	2.03mm
	Category	Inductor/Coilcraft 1008

Navigation: Details | **Parts and Attributes** | Pins | Gates | Assoc Parts

The attributes will be saved to the library with the Part, and added to components inserted into PCB or Schematics designs. See the **Changing Attributes** section below for details of how to ‘over-ride’ these part attribute values with local Component ones.

Footprint Attributes in the Footprint Editor

You can insert attributes for the **PCB Footprints** within the **Library Manager** on the **PCB Footprints** tab using the **Attributes** button or by adding attributes from within the Footprint editor.

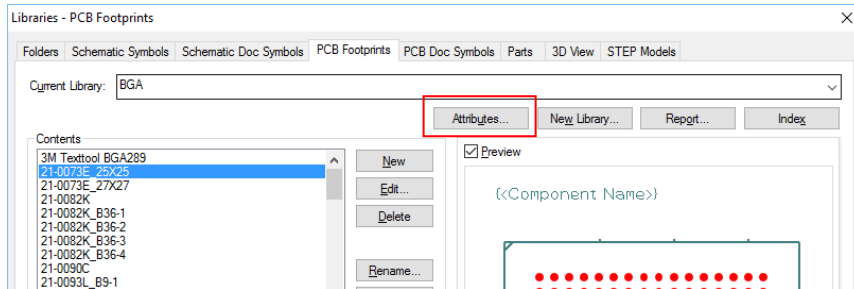

Hyperlink Attributes

Any attribute or text string can be a hyperlink. This feature is enabled through the **Technology** file and **Attribute Names** page. Select the **Attribute Name** and click the check box **Use as Hyperlink**.

Name	Usage	Context	Show Name	Show Value	Use as ToolTip	Use as Hyperlink	Back Annotate	Validation	Copied
<Component Height>	Any Item	PCB Design Only	<input type="checkbox"/>	<input checked="" type="checkbox"/>	<input type="checkbox"/>	<input type="checkbox"/>	<input type="checkbox"/>		<input checked="" type="checkbox"/>
<Hyperlink>	Any Item	All Designs	<input type="checkbox"/>	<input checked="" type="checkbox"/>	<input type="checkbox"/>	<input checked="" type="checkbox"/>	<input type="checkbox"/>		<input checked="" type="checkbox"/>
<Pin Package Length>	Pad	All Designs	<input type="checkbox"/>	<input checked="" type="checkbox"/>	<input type="checkbox"/>	<input type="checkbox"/>	<input type="checkbox"/>		<input checked="" type="checkbox"/>
<Spice Device>	Any Item	SCM Design Only	<input type="checkbox"/>	<input checked="" type="checkbox"/>	<input type="checkbox"/>	<input type="checkbox"/>	<input type="checkbox"/>		<input checked="" type="checkbox"/>
<Spice Node Template>	Pad	SCM Design Only	<input type="checkbox"/>	<input checked="" type="checkbox"/>	<input type="checkbox"/>	<input type="checkbox"/>	<input type="checkbox"/>		<input checked="" type="checkbox"/>

Where the hyperlink is used you can add a link to various file types. With the hyperlink displayed, you can select the **Execute Hyperlink** command from the context menu where Pulsonix will attempt to invoke the appropriate application to read the link. This will work the same as if you had selected a link from your Windows Explorer program.

You can use filenames, such as Word and PDF files, and folders within the hyperlink name, or you can use an Internet URL.

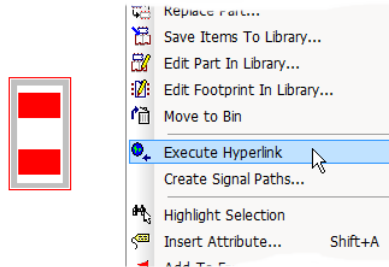

You are prompted with a choice if the item has more than one hyperlink (multiple hyperlinks can be defined in the **Technology** dialog and **Attributes** page).

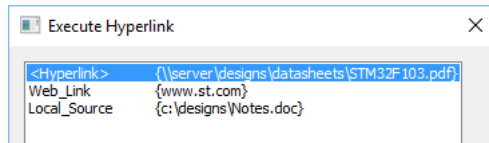

Dynamic Attributes

Attribute values can be ‘plugged’ with values from other attributes. A special substitution character introduces the name of another attribute in the value and also closes it off. The character must be ‘doubled’ when using it, e.g. `%%NAME%%`

When editing an attribute, you can easily create these using the **Substitute Attribute** button. Two or more attributes can be added together to make a substituted attribute string.

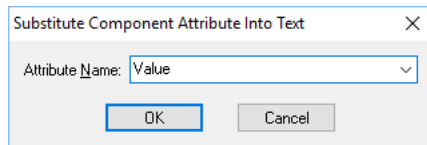

For example, you could create a new ‘dynamic’ attribute by combining two (or more) other attributes. A Component with attributes of **Vendor** and **Value**, could be combined to create a dynamic attribute called **Insert**. The entry in the **Edit Attribute** dialog would look like: `%%Vendor%% %% Value %%` In the design, this would be displayed with the values from each attribute inserted, say **Farnell** and **10K** and respectively. Attribute display for this type of attribute is the same as any other attribute. Note that a space (or any other character) can be used in between each pair of `%%` characters.

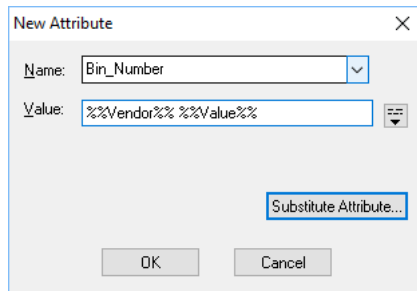

To change the **Attribute Substitution Character** use **Design Settings** options and the **General** tab.

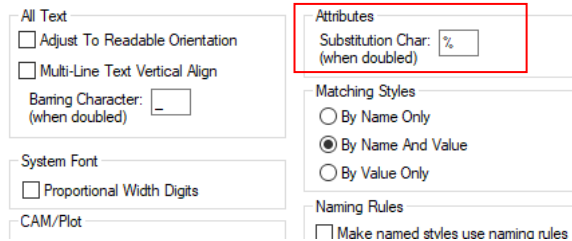

You can also use attribute substitution in hyperlinks. You could use this for defining the folder path and the filename as two attributes which could then be substituted to one hyperlink.

For example, attributes defined for a generic folder: `%%c:\datasheets\%%` and each unique datasheet: `%%AD8592%%` and `%%PIC16F%%` produces (when satisfied):

`c:\datasheets\AD8592` and `c:\datasheets\PIC16F` respectively.

Changing Attribute Properties

Once attributes have been added to a design, footprint or design item, all **Properties** of the selected attribute can be changed; Value (not for system attributes), Position (X,Y position, Angle, Mirrored status, Locked status), Layer and Text Style used, and Alignment.

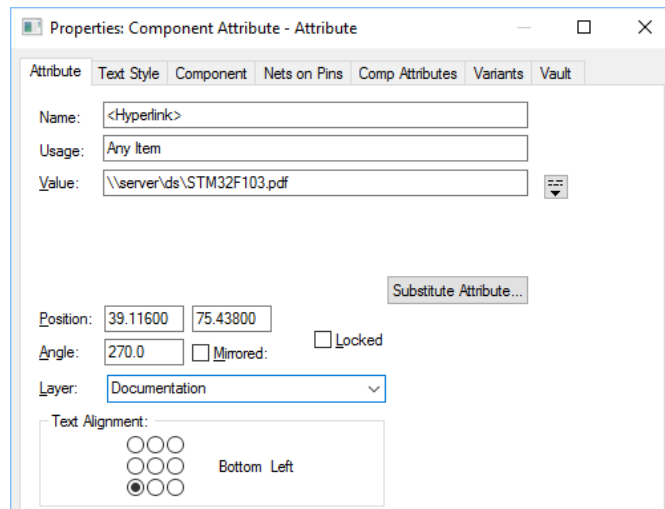

You can also select the visible attribute in the design and delete it. This removes the visible state of the attribute, the attribute still exists on the item though. Use the **Properties** dialog to remove it completely from the item.

If the attribute is not visible, select its owner item and use **Properties** from the context menu. Choose the correct attributes tab, for example if picking a Component Pad on a net you have a **Pad Attributes** tab, a **Component Attributes** tab and a **Net Attributes** tab. The above example shows a selected Attribute for a Component. Note: system attributes are not editable from this list.

If the attribute is not owned by the item, but owned by the Component's **Part** or a **Net** for example, the **Edit...** and **Delete** buttons will be disabled. To over-ride these attribute values with a local copy on the item being edited, use the **New...** button to add an attribute using the same attribute name, but different value. When this is done the **Edit...** button is enabled and the **Delete** button turns into a **Reset** button to indicate it is a local value.

Use the **Reset** button to reset the attribute value back to the original value from the **Part** or **Net**.

Attribute Validation

You can define a wildcard validation string along with an **Attribute** name on the **Technology** dialog. This is used to allow you to define specific values or contents for attributes up-front, and then for Pulsonix to check and verify them.

For example, you could define the **ROHS Compliant Attribute** in the Technology dialog with a **Validation** string of **Yes**. If this is then changed to **No** or another string, it will be flagged by the **Design Rules Check** option.

	Name	Usage	Context	Show Name	Show Value	Use as ToolTip	Use as Hyperlink	Back Annotate	Validation	Copied
	HFE	Any Item	All Designs	<input type="checkbox"/>	<input checked="" type="checkbox"/>	<input type="checkbox"/>	<input type="checkbox"/>	<input type="checkbox"/>		<input checked="" type="checkbox"/>
Y	HS1	Pad	All Designs	<input type="checkbox"/>	<input checked="" type="checkbox"/>	<input type="checkbox"/>	<input type="checkbox"/>	<input type="checkbox"/>		<input checked="" type="checkbox"/>
Y	R	Any Item	All Designs	<input type="checkbox"/>	<input checked="" type="checkbox"/>	<input type="checkbox"/>	<input type="checkbox"/>	<input type="checkbox"/>		<input checked="" type="checkbox"/>
	ROHS	Any Item	PCB Design Only	<input type="checkbox"/>	<input checked="" type="checkbox"/>	<input type="checkbox"/>	<input type="checkbox"/>	<input type="checkbox"/>	Yes	<input checked="" type="checkbox"/>
	Row Spacing	Any Item	All Designs	<input type="checkbox"/>	<input checked="" type="checkbox"/>	<input type="checkbox"/>	<input type="checkbox"/>	<input type="checkbox"/>		<input checked="" type="checkbox"/>



Checking Validation strings

Attribute Validation is checked by **Design Rules Check**, the **Attribute Editor** and **Attribute Properties**. If you attempt to change the value to one not matching the Validation characters, you are presented with a warning dialog:

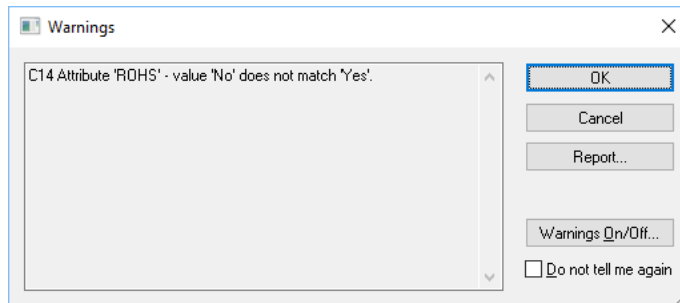

Plotting and printing attributes

Sometimes you may wish to see attributes on certain layers on the screen for information purposes, but don't want these attributes to appear on any plots output. To switch off these attributes use the following procedure:

Select **CAM/Plot** from the **Output** menu and select the appropriate plot from the list provided. Use the **Edit...** button to enter the **CAM Plot Wizard**. On the **Process** stage of the wizard, select the **Exclude Items...** button. You will be presented with a dialog titled **'Exclude items From The Plot'**. Use this to move attribute names from the **'Choose from'** list to the **'NOT to be PLOTTED'** list to exclude them from the plot. Finish the wizard to apply the changes.

The Pulsonix Vault

When setting up your design, you may choose to use the Pulsonix Vault to manage your **Libraries**, **Designs**, **Technology** files, **Profile** files and **Block** files. This allows the vault to be used a Revision Control and Management system for your Pulsonix documents.

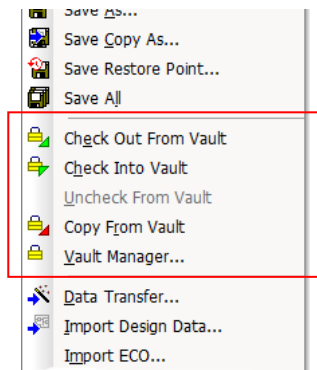

With the appropriate license enabled, the **Vault** management tool is primarily situated on the **File** menu.

Below is a brief introduction to the Pulsonix Vault. *More detailed information can be found in the Online Help and within the Pulsonix Vaults Users Guide.pdf file*

Installing the Vault

By default, the Pulsonix Vault is not installed. Because it uses a separate database mechanism to save and manage data, it must be installed as a separate process.

Everything required to install the Vault is provided in a self-contained file.

CD Install

If installing from the Pulsonix **CD**, browse to the **Vaultserver** folder and click on the **VaultAdminSetup.exe** file to start the installation. This file contains everything required to install the Vault.

Download/Web Install

If receiving Pulsonix via the internet, the Vault server installation is a separate download. This will be located with the Double click on the **VaultServerSetup.exe** program to start the installation. Again, this is a self-contained file containing everything required to install the Vault.

For either method, the installation is a three part process:

1. **Install the PostgreSQL Server** – this is the service that contains the Vault.
2. **Create Vault Database** – you must create a Vault database to use with Pulsonix.
3. **Choose Data Folder** – you must choose where Pulsonix will store Vault data.

As already mentioned, this is a brief overview of the Vault in this document. *Refer to the Online Help for more information.*

Once installed, the Vault is managed from within the Pulsonix program.

Vault Manager

The Vault Manager controls all aspects of the revision control and management of Pulsonix design items:

The screenshot shows the Vault Manager interface with the following components:

- Browser:** Libraries to Vault, Designs to Vault, Generic Files to Vault, Audit Trail
- Vault Folders:** Refresh button and a tree view containing folders like Parts, 3m, Actel, AD, ADSP, Altera, Altera2, AlteraCyclone, AMP, Assmann, Atmel, Avago, AVX, Bourns, Capacitor, CoilCraft, Coldfire, CWR, Dies, Diode, Fairchild, FCI, Fuse, Generic, Glenair, Hardware.
- Vault Items:** 16 items listed in a table.
- Item Details:** Refers To dropdown and Revision: <Latest Revision> dropdown.
- Item Table:**

Item ID	Type	Folder	Name	Revision
53529	Part	\Library Content\Parts\Actel	A40MX02-PL44	1.0
53531	Part	\Library Content\Parts\Actel	A40MX02-PL68	1.0
53530	Part	\Library Content\Parts\Actel	A40MX04-PL44	1.0
53532	Part	\Library Content\Parts\Actel	A42MX09-PL84	1.1
53533	Part	\Library Content\Parts\Actel	A42MX16-PQ160	1.0
53521	Part	\Library Content\Parts\Actel	A54SX08A1-TQ100	1.0
53519	Part	\Library Content\Parts\Actel	A54SX08A-TQ100	1.0
53522	Part	\Library Content\Parts\Actel	A54SX08A-TQ144	1.0
- Item Table (Detailed View):**

Item ID	Type	Folder	Name	Revision	Timestamp
9121	PCB Footprint	\Library Content\Footprints\LCC	PLCC84-MX	1.1	02-12-2016 16:08:1
11134	Schematic Symbol	\Library Content\Schematic Symbols\Actel	ACTEL-B16	1.0	31-10-2016 19:25:4
11139	Schematic Symbol	\Library Content\Schematic Symbols\Actel	ACTEL-L6	1.0	31-10-2016 19:25:4
- Preview Of:** Part 'A42MX09-PL84'
- Preview Images:** A schematic symbol and a physical footprint of the PLCC84-MX component.
- Properties:**
 - <Part Family>=A4
 - Category=FPGA/MX
 - Description=MX FPGA
 - Mfr=Actel

Key Concepts of the Vault

What can be stored in the Vault?

The Vault can hold the following types of 'library' data: Parts, Footprints, Schematic Symbols, and Schematic, PCB Doc Symbols, 3D Packages and STEP models.

It can also hold the following types of design-based data: Schematic and PCB Designs, Schematic and PCB Technology Files, Schematic and PCB Profiles, Schematic Block Files and PCB Panels.

In addition, 'Generic' files such as Gerber and Excellon, ODB++, BOMs and other non-native file formats can be stored within the Vault.

The Vault is designed to provide you with a secure environment for managing your 'published' data. You may still use locally-stored design files and native libraries for developing data, and release your completed items to the Vault when you are ready to do so.

What is an 'item'?

Each item that is placed into the Vault is given a unique item identifier, or "IID". Each time that item is saved to the Vault, a new version of the item is created, with this latest version having a new version timestamp or "Version". This is distinct from the "Revision", which we will hear more about in a moment. In this way, the Vault contains a full history of all revisions of an item.

The IID combined with the Version uniquely identifies a specific version of an item. In this way a Part for example can know which exact version of a Footprint it is to use. Not just any version of the Footprint, only the specific version that is indicated by the IID and Version listed in the information held along with the Footprint name inside the Part.

Other Vault item properties

In addition to each item having its own Item ID, every Vault installation has its own Vault ID. This allows the application to clearly identify an item as belonging to the current Vault. This means you cannot share items across separate Vaults, because there is no safe way of ensuring the uniqueness of the item ID of items created in different Vaults. You can still take an item from one Vault and check it into your own Vault as a new item, at which point it will be assigned a new item ID.

Cross References

Depending on the settings you use when publishing your data to the Vault, the application will maintain cross-references between related items, allowing rapid access to information such as ‘Where Used’ without having to resort to time-consuming compilation of reports.

Managing and updating Vault items

There are four basic actions which you can use to manage your Vault items. Your Permissions will control which of these actions are available to you for the various types of item in the Vault.

Check Out

Check Out will “book out” an item from the Vault for you to make changes. This action will be recorded in the Audit Trail, and the item will be marked as checked-out by you to prevent other users from making changes to it at the same time. They will still be able to access the item, for example for a Part they will still be able to use that Part in one of their designs, but they will not be able to check it out to alter it until you have finished with it.

Check In

After modifying an item, Check In will “book it in” to the Vault to commit your changes. Another record is placed in the Audit Trail, the item you are checking in is given a new revision, the ‘lock’ on it is released, and the newly modified item is available for others to use.

You can also Check In an item that is not yet in the Vault, including newly-created items such as Parts and Footprints.

Uncheck

If you have used Check Out to book out an item to change it and then change your mind, you can use Uncheck to release your hold on that item.

Copy Out

If you need to use an item for something without actually changing it, then Copy Out can be used to pull a copy of the item to be stored locally. You might want to use this for example to open a PCB design to generate manufacturing data or run reports, actions that don’t actually change the design in a way that you want to record.

Vault Admin Tools

The Vault admin tools on the Setup menu allows you to control and manage aspects of the Vault system that are not directly related to revision control or data management.

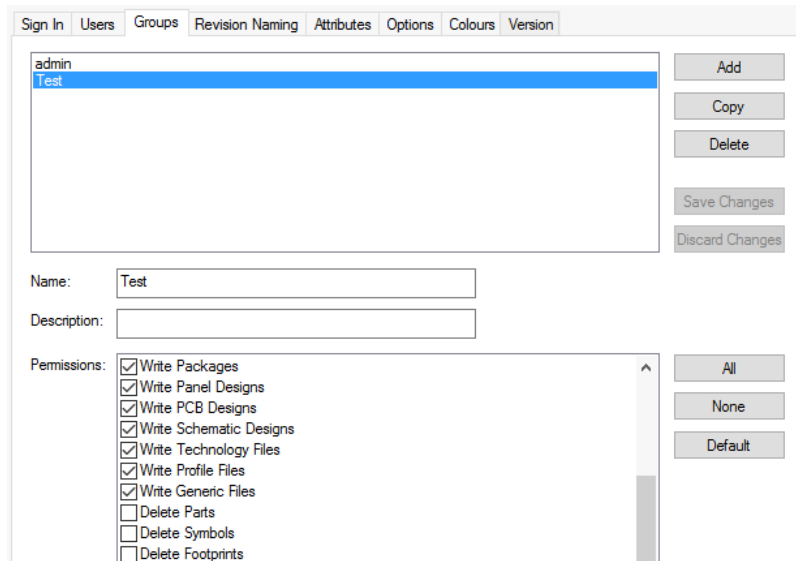

Adding Vault Items to a Design

There are a number of ways to add components to your design from the Vault. Primarily, you can use the **Insert component** option or **Part Browser** bar.

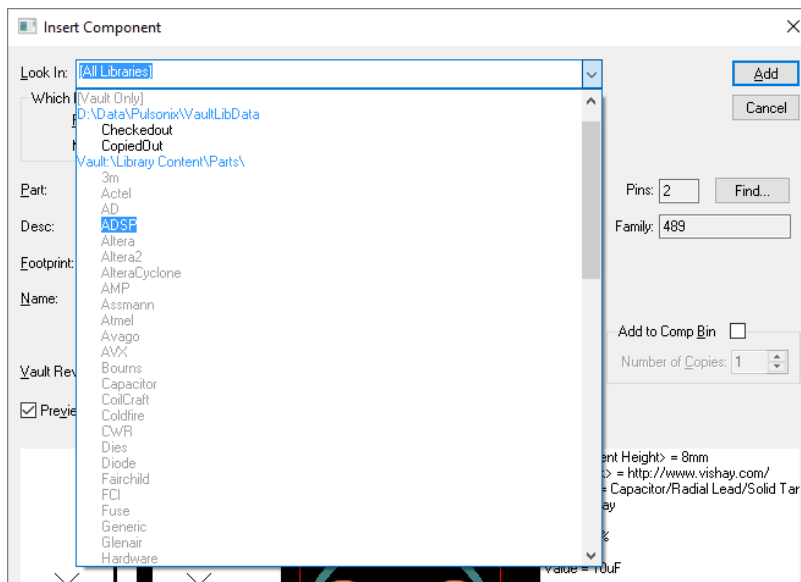

Chapter 5. Schematic Capture Editor

Getting Started

There are a number of ways of starting a new Schematic within Pulsonix.

- You can start with the supplied Technology files and/or Drawing Profile. This is the preferred and recommended method of starting a Pulsonix design.
- You can start with an empty design, that is, no Technology files, and no Drawing Profiles. You would add the necessary styles etc. to the design as you need them.
- You can start by importing a design from another system using the import mechanism. Once the Schematic has been imported, a Technology file can be made from it as can a Drawing Profile, and libraries imported or created from the design.

The discussion below deals with the basic start, with and without Technology files and Drawing Profiles. It then builds the design using the natural design flow as a guide, adding design items as they are required, each topic deals with one feature of the process.

Starting a New Drawing with Default Files

Regardless of which active window is currently open in Pulsonix, you can start a new **Schematic** design using the **New** option. This dialog can also be used for starting new designs (Schematics and PCB), Library items, Technologies, Profiles and access to the Library item creation wizards.

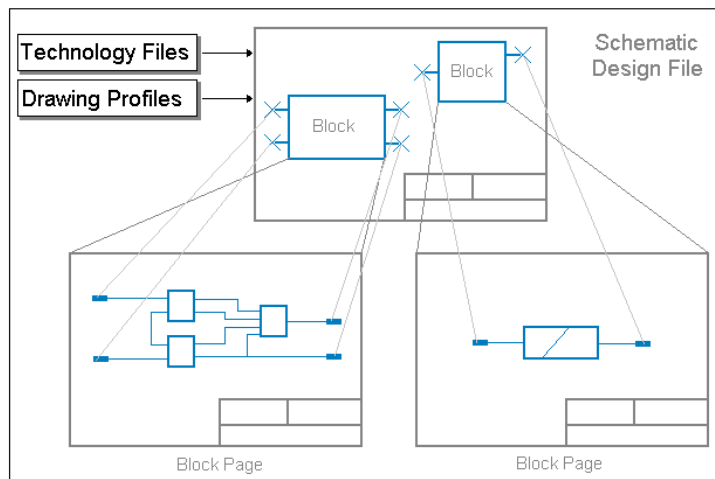

Once you've decided to start the new schematic, you then need to decide whether you require a Technology file and/or a Profile file.

The Technology file contains information such as the Styles, predefined Net Names, Attribute Names and Colours. The Drawing Profile file can contain documentation items such as a Page Border. You can start without either of these files and add them to the design later. It is better practice to start with the Technology file at least, although the Drawing Profile file is also useful because it provides a localised area in which to work and also is a guide to the printed page size for later on.

► To start a new Schematic design

1. On the **File** menu, click **New**

It is better to start with a **Technology** file. The styles and values used in it will be the same as the styles used in the supplied libraries. Although this is not too important, it makes it easier to understand if you are just getting started with Pulsonix.

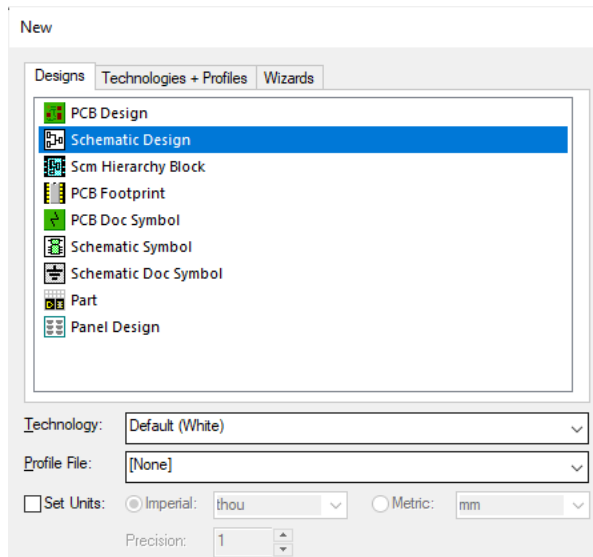

2. Click on the small 'down' arrow on the **Technology** drop down list
3. From the list of **Technology** files select **Default (White).stf**
This is one of the default files supplied until you create and save your own.
4. Leave the **Profile File:** entry as **[None]**, unless you require a page border.
5. Use the **Set Units** to override the **Units** defined in the **Technology** file.
6. Click the **OK** button to start a new Schematic design.

Design Options for Schematic Design

Before getting started on the design itself, you should check that when you start adding design items, the editor will behave as you expect or wish it to.

Many characteristics of design items are set up in the **Design Settings** dialog from the **Setup** menu and in particular on the **Defaults** tab. Once you start editing the design and adding new items to it, you should also check on the **Options** dialog from the **Tools** menu, to ensure that the **Edit Connection** and **Interaction** tabs are set to your own preferences. Pulsonix is a very flexible system and allows many of the options to be customised to suite your particular style of working.

The **Defaults** page sets up the styles and values used when adding new items to the design.

In this example, the **Bus Terminal** defaults are shown:

Line Style:

Name Style:

Bus Terminal Offset:

Bus Terminal Direction:

Up (on vertical bus segments)

Right (on horizontal bus segments)

In Dialogs - Apply Styles to All Connected or Same Name Busses

Unless an item is pre-selected, the default style defined in this dialog is used. If a similar item is pre-selected, inserting a new item of the same type will inherit the style of the item. For example, if text is added to a design and the text style then changed from say *Normal* to *Large200* (*Normal* being the Default), if the text remains selected, the next text item added will use the *Large200* style even though the default is *Normal*.

The **Naming** page in the **Options** dialog contains very specific information regarding the characteristics of design items, items such as the leading character or symbol used for the default system net names, e.g. whether N0001, or \$1 is used (or another character).

<p>Force To Upper Case</p> <p><input checked="" type="checkbox"/> Component Names</p> <p><input type="checkbox"/> Gate Names</p> <p><input type="checkbox"/> Net Names</p> <p><input type="checkbox"/> Part Names</p> <p><input type="checkbox"/> Pin Names</p> <p><input type="checkbox"/> Test Point Names</p>	<p>Name Options</p> <p><input checked="" type="checkbox"/> Case Sensitive Pin Names</p> <p><input type="checkbox"/> Numeric Gate Names</p> <p><input checked="" type="checkbox"/> Fill-In Gaps In Number Ranges</p>
<p>Default Net Names</p> <p>Name Stem: <input type="text" value="\$"/></p> <p>Number Width: <input type="text" value="0"/></p>	<p>Name Ranges</p> <p>Range Start: <input type="text" value="["/></p> <p>Range End: <input type="text" value="]"/></p> <p>Range Separator: <input type="text" value="-"/></p> <p>Item Separator: <input type="text" value="."/></p> <p>Example: U1,U[3-6]</p>
<p>Local Net Names</p> <p><input checked="" type="checkbox"/> Default to local names</p> <p><input checked="" type="checkbox"/> Names Unique Across Design</p> <p>Local Name Prefix: <input type="text" value="!"/></p> <p>Owner-Net Separator: <input type="text" value="!"/></p> <p><input checked="" type="checkbox"/> Owner Before Net Name</p>	<p>Pin Names</p> <p>Component to Pin Name Separator: <input type="text" value="."/></p>
<p>Net Pages Attribute</p> <p>Prefix: <input type="text"/></p> <p>Separator: <input type="text" value="."/></p> <p>Newline After: <input type="text" value="0"/></p> <p><input type="checkbox"/> Show Current Page</p> <p><input checked="" type="checkbox"/> Show Page Number (instead of Name)</p>	<p>Component Names</p> <p><input checked="" type="checkbox"/> Display Gate Name</p> <p>Gate Separator: <input type="text" value="-"/></p> <p><input checked="" type="checkbox"/> Display Connector Pin Name</p> <p>Connector Pin Separator: <input type="text" value="."/></p>
<p>Page Link Attribute</p> <p><input type="checkbox"/> Show Page Number (instead of Name)</p>	<p>Part Names</p> <p><input type="checkbox"/> Display On Each Gate On Page</p>

The **General** page in the **Options** dialog allows you to set up more general design items.

The screenshot shows the 'Options' dialog box with the 'General' page selected. The dialog is organized into several sections:

- All Text:**
 - Adjust To Readable Orientation
 - Multi-Line Text Vertical Align
 - Barring Character: (when doubled)
- System Font:**
 - Proportional Width Digits
- CAM/Plot:**
 - Transform about design extents
- Attributes:**
 - Substitution Char: (when doubled)
- Matching Styles:**
 - By Name Only
 - By Name And Value
 - By Value Only
- Naming Rules:**
 - Make named styles use naming rules
- Blocks:**
 - Allow Multiply Instanced
- Schematics Top Level:**
 - Name:
- Spacing Rules:**
 - Enable linking of types
- Schematics Implied Junctions:**
 - Display Implied Junctions

These dialogs are pre-programmed with built-in settings and should only be changed if you understand what they do and need to change them. Some of the settings can only be changed before a design is started where there are no design items in the design itself already. Some items can be changed after the design is started but the system updates itself to adjust all the design items that already used these settings, e.g. Default Net Name stem.

Saving Design Settings and Options

All **Design Settings** options are saved in the design, and so only effect the design you are editing. Other parameters used in the **Options** dialog are saved to the system's Registry and so are set up for every design that you subsequently create or edit.

The **Design Settings** options are saved with the Technology files and so, once your preferences have been worked out, this allows for the same settings to be used when the Technology files is selected in future Schematic designs.

When setting up **Design Settings**, you must also consider whether your design will use hierarchy and what style that hierarchy might be, multiple-instanced or not. This is covered in more detail later on in this *chapter* under *Hierarchy*.

Setting up your Technology

The concept of Technology files has already been discussed in a previous Chapter. This section details specific uses of Technology with the Schematic design editor.

One other important consideration when setting up Technologies is the final process of translating to the PCB design and how the PCB handles the items used in the Schematics. The Pulsonix PCB design editor will use any **Net Names**, **Net Class Names**, **Net Class Rules** and **Attribute Names** used in the Schematic when transferred.

Schematic Technology dialog

The illustration below shows the major styles used in components and Documentation Symbols, Connectors and Testpoints. These are all accessed from the **Technology** dialog.

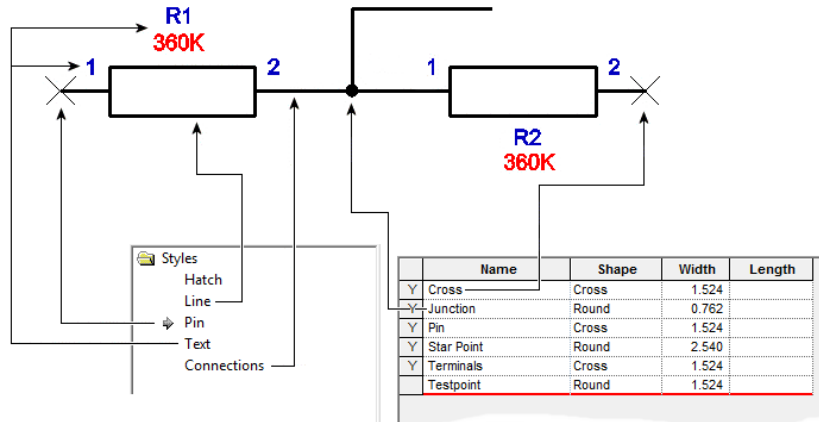

Pin Styles are used to define the appearance of pins and junctions that connections are attached to. These can be one of any of the shapes available, with a **Width** and for some shapes a **Length**. An **Offset** value can also be defined for both X and Y offsets.

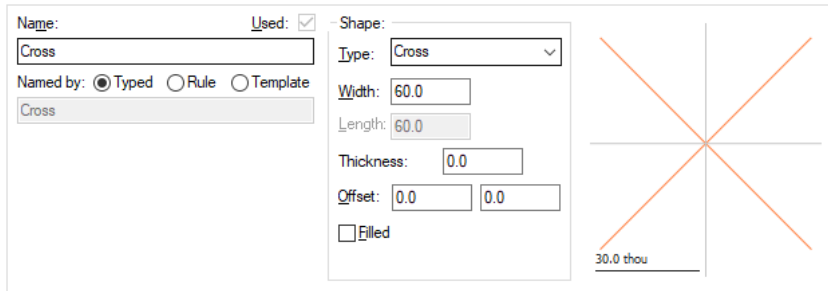

This enables you to display the pin in an offset position from that of the actual connection point.

Connections obtain their **Line** widths from the **Connections** dialog.

The **Line Styles** dialog is used for the line widths of Symbol outlines, Blocks, Busses and all other line items.

The **Text Styles** dialog is used for the appearance of Component Names, Pin numbers, Net names and all other text items.

The **Net Names** dialog is used to list the user defined net names used in the Schematic. You can set a nets Net Class name (see below) and whether the net is Local (i.e. only to be used on one page), or Global, available to all pages of the design, e.g. VCC or GND.

The **CAM Plots** dialog allows plots and prints to be setup in advance. These are saved in the Technology data along with the other design information. Plotting the design is covered in detail at the end of this chapter in the section under *Plotting The Schematic*.

Other facets of the Technology are discussed as they are used in this manual.

Rules

From within the **Technology** dialog you can also define **Rules** that will be passed through from the Schematic to the PCB design. Different levels of rules can be passed through during the **Translate To PCB** phase. For example, you can define rules for Spacings, Min and Max Track width, or Min and Max Pin Lengths. These net classes are then applied to a net or multiple nets within the design.

All of this detail is then passed through into the PCB design where it can be used and checked again on the physical design. This allows the engineer to define some of the critical electrical parameters of the design that the board layout designer can then use.

In the example below, the Differential Pair rule is shown:

Enable	Attribute Name	Match Value	Side	Layer	Area	Allow Tracks	Use Spacing	Min Gap
<input checked="" type="checkbox"/>	<Differential Pair Name	FMC*	Inner			<input checked="" type="checkbox"/>	<input type="checkbox"/>	8.0
<input checked="" type="checkbox"/>	<Differential Pair Name>	FMC*	Outer			<input checked="" type="checkbox"/>	<input checked="" type="checkbox"/>	<Undefined>
<input checked="" type="checkbox"/>	<Differential Pair Name>	Diff1_?				<input checked="" type="checkbox"/>	<input checked="" type="checkbox"/>	<Undefined>

Changing the Colours of the Schematic

All item colours within the Schematic design can be changed using the **Colours** dialog. The use of this dialog has been discussed in a previous chapter, *Setting Up The Design*.

The illustration below shows how the design is constructed using different colours for the different design items:

The schematic diagram shows a circuit with components labeled A0, C1, R1, Vcc, and Gnd. The diagram is annotated with arrows pointing to various elements, which are then detailed in three color configuration tables:

Colours – Bus & Connections

Name	Displayed	Selectable
Bus	<input checked="" type="checkbox"/>	<input checked="" type="checkbox"/>
Connections	<input checked="" type="checkbox"/>	<input checked="" type="checkbox"/>
Connect Guides	<input checked="" type="checkbox"/>	<input checked="" type="checkbox"/>

Colours – Shapes

Name	Displayed	Selectable
Shapes	<input checked="" type="checkbox"/>	<input checked="" type="checkbox"/>
Sym. Shapes	<input checked="" type="checkbox"/>	<input checked="" type="checkbox"/>
Doc.Sym. Shapes	<input checked="" type="checkbox"/>	<input checked="" type="checkbox"/>
Block Sym. Shapes	<input checked="" type="checkbox"/>	<input checked="" type="checkbox"/>
Block Port Shapes	<input checked="" type="checkbox"/>	<input checked="" type="checkbox"/>

Colours – Connect Points

Name	Displayed	Selectable
Sym. Pins	<input type="checkbox"/>	<input checked="" type="checkbox"/>
Doc. Sym. Pins	<input type="checkbox"/>	<input checked="" type="checkbox"/>
Block Sym. Pins	<input checked="" type="checkbox"/>	<input checked="" type="checkbox"/>
Block Ports	<input checked="" type="checkbox"/>	<input checked="" type="checkbox"/>
Junctions	<input checked="" type="checkbox"/>	<input checked="" type="checkbox"/>

From within the **Colours** dialog, **Text** categories are also available for (free) **Text**, **Sym Text** and **Doc Sym Text**.

*Grid colours are set up in the **Grids** dialog as discussed previously.*

Using a Drawing Profile (Page Border)

There are three methods of adding a page border to a Schematic design depending on whether you are using predefined page border or are creating it from new. It is recommended that you use **Drawing Profile files** for this purpose.

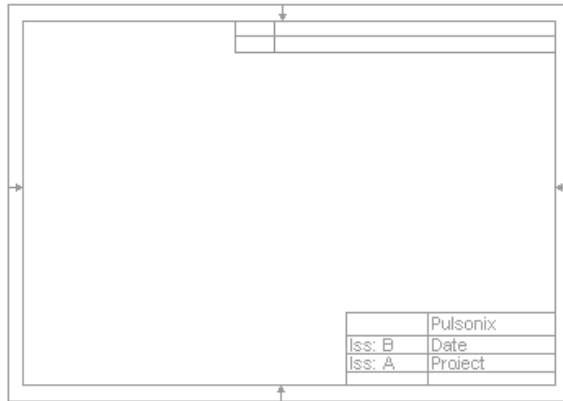

Drawing Profile file - predefined Drawing Profile files can contain page border outlines in various sizes to start the design. These may already exist to be loaded into any Schematic page, or created within a design and saved as a Drawing Profile file. The supplied Drawing Profile files can be edited and saved to suite your own style required.

Created Interactively - using the **Insert Shape** and **Insert Text** options you can create the shape outlines and add any text required (this can then be saved to a Drawing Profile file to be used with other designs).

Documentation Symbol - Documentation symbols created and stored in the Documentation Symbol library can be added to the design as 'ready-made' page borders to use, this method is used by many other systems. If importing from another system these page borders will be converted to the Pulsonix Doc Symbol library.

Adding a Drawing Profile File

Once created, Drawing Profile files can be added to the design like most other items. These can be added at any time during the design process but it does make sense to add them early on to give you a guide to the size of the page and the area you have to work in. Adding Drawing Profile files while using the **New** option is the most efficient way of doing this, but they can also be added later by using the following procedure.

► To add a Profile File

1. On the **Setup** menu, select **Load Drawing Profile**.

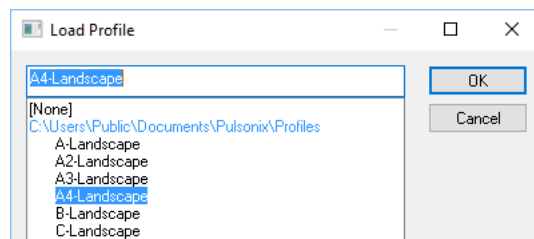

2. From the list, select a **Profile** file from the list. This file should be one that suites your eventual printing or plotting output requirements. The list of Profile files available is taken from the path(s) defined in the **Folders** option.
3. Click **OK** to add the drawing profile file to the design.
4. The profile will be added to the design but remains selected for repositioning. Click in free space to deselect it. If you wish to move it, select the outline and drag to the new location.
5. If a drawing profile already exists in the design, it will be replaced with the new one selected.

Resolving Styles during Insert Profile

When saving Drawing Profile Files, the contents of the file can contain Styles not defined in the Technology you choose for the Schematics, it could also be that the Styles in the Drawing Profile file and the Technology file match in name but not in definition within it.

When a Profile is loaded, any Styles used in the file will be used if they already exist providing the name and the contents match. If they don't match, a new style is added to the Technology dialog. Most important, is that the Style contents are maintained, the thickness and sizes etc.

When creating the Drawing Profile file, you should attempt to use the Technology file that will be intended for use with the Schematic designs.

Adding Documentation Symbols

Documentation Symbols can be used to define Page Borders. This is covered in the chapter headed *Adding Documentation Symbols*.

Creating Page Borders interactively

Page borders can be created interactively using the options provided within Pulsonix. Please refer to the chapter headed *Adding Shapes* for more details.

Using the Component Bin

This section details how the Component Bin is used in the Schematic design editor. An overview on how the Component Bin works generally can be found in the previous Chapter, *Using Pulsonix*.

The Component Bin in Schematics is used mainly as an off-page Bin for unused components and connector pins. You would use it to hold components or Connector pins that are unplaced but that you know you will need later on, or unused gates that form part of multi-gated component already used in the design. When multi-gated components are deleted, the gates are put in the Bin until all of that component's gates have been deleted from the design.

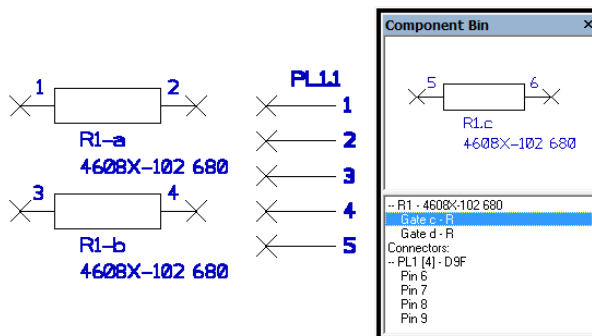

Schematic components can be added directly to the Component Bin during the **Insert Component** operation as shown earlier in this Chapter. However, if you have components in the design that you wish to move into the Bin temporarily while editing another area of the circuit you should be aware that if connected at the time, the connections will be lost. Unlike the PCB editor that removes tracks but retains the connectivity, the Schematic editor loses the connection. If you move a connected Schematic Component into the Bin by mistake, use the **Undo** option to retrieve it.

Components, gates or Connectors placed in the Component Bin will not be transferred to the PCB design during **Translate To PCB** unless they form part of an existing multi-gated Component already used in the design. Any completely unused components etc. in the Bin will be ignored.

Adding Components

Once the **Design Settings** have been set and the **Drawing Profile** (Page Border) inserted, the Schematic editor is ready for the design to be created.

One of the first processes to attempt is the insertion of Symbols into the Schematic design; Pulsonix provides the **Insert Component** function for this purpose.

Part and Symbol contents are created and saved into corresponding libraries. The Part entry contains a Part name, a Footprint (optional if translate to PCB isn't required) and a corresponding Schematic Symbol or multiple symbols if the Part represents a multi-gated Component.

Note: In Schematics, an instance of a Part used in the design is called a Component.

When using multi-gated components, in the **Design Settings, Naming** dialog, you can define whether the **Gate Name** is displayed or not by selecting the check box. This displays gates like this: U1-a, U1-b etc. The **Gate Separator** character can also be defined depending on how you want it to look, U1-a, U2,a, U3/a etc.

The image shows a screenshot of the 'Naming' dialog box in Pulsonix. The dialog is divided into several sections:

- Force To Upper Case:** Contains checkboxes for 'Component Names' (checked), 'Gate Names', 'Net Names', 'Part Names', 'Pin Names', and 'Test Point Names'.
- Name Options:** Contains checkboxes for 'Case Sensitive Pin Names' (checked) and 'Numeric Gate Names'.
- Default Net Names:** Includes 'Name Stem' (text box with '\$') and 'Number Width' (text box with '0').
- Local Net Names:** Includes checkboxes for 'Default to local names' (checked) and 'Names Unique Across Design' (checked), along with text boxes for 'Local Name Prefix', 'Owner-Net Separator', and a checked 'Owner Before Net Name' checkbox.
- Net Pages Attribute:** Includes text boxes for 'Prefix', 'Separator', and 'Newline After' (text box with '0'), and a checked 'Show Current Page' checkbox.
- Name Ranges:** Includes text boxes for 'Range Start', 'Range End', 'Range Separator', and 'Item Separator', along with an 'Example' field showing 'U1,U[3-6]'. The 'Range Start' and 'Range End' boxes contain '[' and ']' respectively.
- Pin Names:** Includes a 'Component to Pin Name Separator' text box.
- Component Names:** This section is highlighted with a red box and contains a checked 'Display Gate Name' checkbox and a 'Gate Separator' text box.
- Part Names:** Includes a checked 'Display Connector Pin Name' checkbox and a 'Connector Pin Separator' text box.

The creation of Parts is covered later on in the manual in the Chapter on *Library Management*.

Using the Insert Component dialog

Using **Insert Component** will allow you to select the required Part from the appropriate library or libraries.

Use **Look In** to choose the libraries you are going to search for the required Part. Normally **[All Libraries]** will be used to search all libraries in the Library folder, otherwise, select the library name or use **[Current Design]** to search components in the design. All other libraries available in the drop down list will be shown using their own name.

Which Parts enables you to filter the search list to find specific Parts. You will notice that with no filter information or * (any), the **Matched:** numbers may be uneven, e.g. 1654 of 2952, this means that there are some Parts in the libraries that are PCB only Parts and as such, unavailable for Schematics. The Filter box can take any name and wildcard characters.

*Wildcards can be used to make the filter more efficient. (Wildcards are special characters that are used to match any character rather than being specific, for example * and ?). For example, 74LS* More information about using Wildcards can be found in the on-line help.*

The **Pins** box is used to limit the matching parts to those with a known number of pins (blank means any pin count).

Once a Part or range of Parts matching the Filter selection have been found, the first Part available will be shown in the **Part** list. This will display the full Part name (4608X-102 680) and the Library from where it came, shown in braces, e.g. {Resistor}.

From the Part library entry, the available alternative **Footprint** entries will be loaded into the Part drop down list, e.g. SIP8. These may be surface mounted alternatives or different packages available for the Part. Choose the required Part and Footprint.

The **Name** box shows the default name stem for this Part (taken from the Parts library default Component Name Stem entry) and the next available number in the sequence. Both the name stem and the number can be edited if required.

Type in the name required of the Component. The default name presented will be constructed from the Name stem taken from the Part in the library, e.g. R and a number to form a unique name as yet unused in the design, change this if required.

The Gates entry is only shown if the chosen part has multiple gates and you are not adding to the Component Bin (only whole components may be added to the bin).

The default gate identifier is the next free gate of this type that is not yet used in the design. For example, if **U1-a** and **U1-b** are already placed on a sheet in the design, then **U1-c** will be the default name. The list box will contain the names of unused gates on the Component using the typed name.

The **Component Bin** check box can be selected if you wish to add the Component(s) to the Component Bin. These components can then be dragged from the Bin into the design at a later stage. The **Number Of Copies** box allows you to add multiple parts to the Bin in one operation. Please refer to the section below on *Using Component Bin* for more information.

The **Preview** check box opens the preview window allowing you to view the Component before it is inserted into the design, this gives you chance to visually inspect it to ensure that it is the current one. Checking the **Schematic & PCB** box will also allow you to preview both design views of component selected. The Attributes button will preview **Attributes** associated with that component.

The **Vault** button will display information about the Part if it has come from the Vault (the Vault must be installed and active for this button to be displayed).

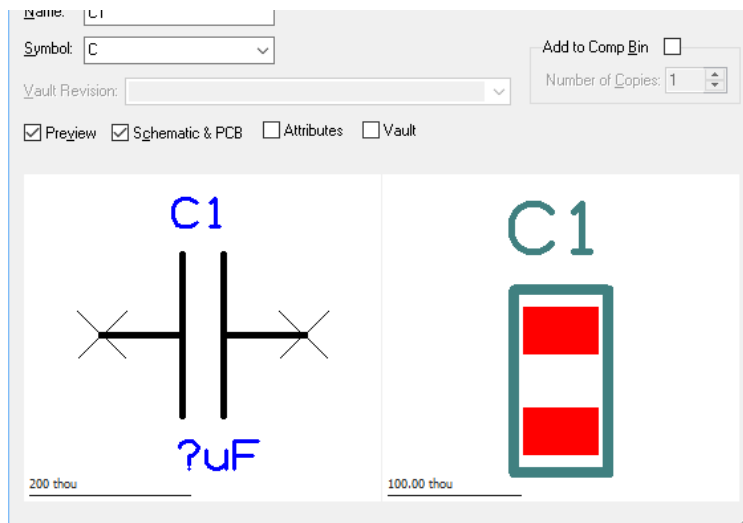

Once you have the Part you require (shown in the Preview window) and its Footprint and Name are correct, you can add it to the design using the **Add** button.

If you are not adding to the Component Bin, the **Add** button will dismiss the dialog from view and will allow you to interactively add as many Parts of the type selected as you like to the design. If you require a **different Part** you should cancel this process by pressing the <Esc> key on the keyboard. This will immediately return you to the Insert Component dialog from where you can make further Part selections. If you wish to **cancel Insert Component** completely, having finished this process, use the **Cancel** button from the Add Component dialog.

Adding Multiple Components in Arrays

After selecting the **Insert Component** option, if you then right mouse click while the Component is dynamic, you can select the **Insert Multiple Items** option from the context menu.

From this you are presented with the **Insert Multiple Components dialog**:

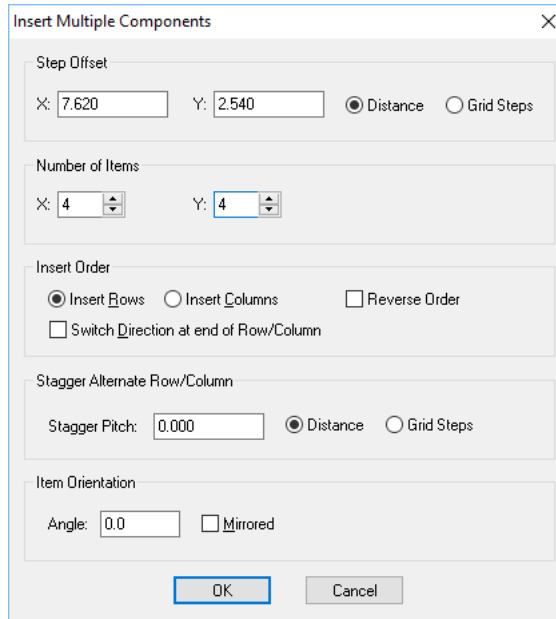

The **Step Offset** defines the distance each Component is offset from the previous one. There are separate values for X and Y and they may be negative to step in the reverse direction.

The **Number of Items** defines the number of items in the X & Y directions. These numbers include the original as the first item (so they start from 1).

Use **Insert Order** to define the order that the items are added. First select **Insert Rows** or **Insert Columns** to specify the items are added in rows or columns, and check the **Switch Direction** box to specify that the next row is started above the end of the previous row, or leave unchecked for each row to be added in the same direction.

Press **OK** to add the multiple items. They will all be dynamically displayed on the cursor for you to click in the required position. Use **Insert Multiple Items** again to alter the item counts or gaps between them whilst placing the items. Set the counts to 1 to go back to adding a single item.

Interactively positioning a Component

Whilst using the mouse to add the Component or Gate, you can use the context menu to change its angle and to mirror it, for example, or to change the size of the grid steps that the Component is being moved by. This is explained in detail in the Chapter *General Utilities* under *Moving Items*.

Use the **Next In Sequence** option from the context menu to increment the Component name and gate identifier to the next free Component or gate not used in the design. Click to position the Component or gate at the required position.

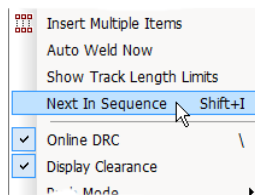

Once in the design, components can be repositioned using the **Move** option or by selecting and dragging them.

Using Decoupling Capacitors

Decoupling or bypass capacitors are frequently used in the design process. There are quite often equal amounts of decoupling capacitors to integrated circuits, on large digital designs this can mean a lot of work to add lots of these devices. Pulsonix has a short form notation for using one device to represent many devices by using a simple naming convention.

When naming a single capacitor Component you can use the notation *name[1-3]* where 1-3 represents the number range, e.g. C[1-3]. After **Translate To PCB**, this will become 3 individual capacitors of the same Part type and will be named C1, C2 and C3.

The **Name Range** characters used are set up in the **Design Settings** dialog under **Naming**.

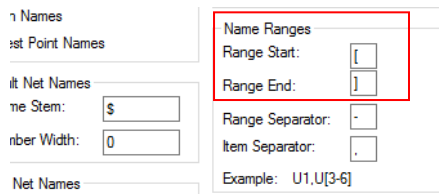

The **Range Start** and **Range End** are the characters used to enclose the range numbers e.g. C[1-3]. The **Range Separator** is used to 'split' the number range, e.g. C[1-3] and the **Item Separator** is used when there is more than one Component name or if the sequence is not sequential, e.g. C1, C[1-3]



Note: this naming methodology applies to other components as well, not just capacitors.

► To add decoupling capacitors

1. From the **Insert** menu, select **Insert Component**.
2. Click on the **Name** box and type the name range required, for example **C[1-4]**
3. The dialog will now recognise the name range and display the message **Range of X components**.

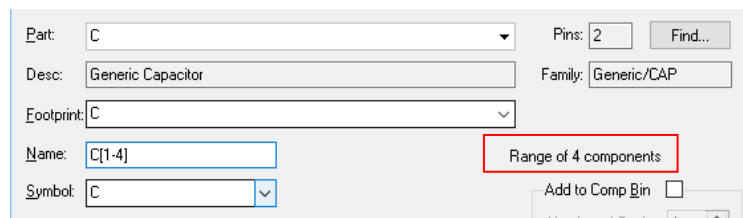

► Alternative method for naming decoupling capacitors

1. Insert a capacitor Component into the design from the **Insert Component** dialog.
2. Click on the **Component Name** e.g. **C1**, right click and select **Properties, Component** page.

3. Edit the Component **Name** to create the name range required, e.g. **C[1-3]**. This is verified with the message **Range of X components** as shown above. If the name range has been defined incorrectly, when you attempt to exit the dialog, it will tell you to correct the error first.
4. Click **OK** to accept the new name.
5. If the name range contains a name that has already been used, then a warning dialog will be displayed when you attempt to exit and you will need to correct it before you can apply the range.

Note: As an alternative to using named ranges for decoupling capacitors, you can also use the Pin Network option. Please refer to the Online Help for further information.

Adding Connectors

Connectors in Pulsonix are Parts that have a special ‘connector’ flagged set during the Part creation. As a Schematic representation, they are usually pins on the designs that can be individually placed, but which refer to one PCB Component. In Pulsonix you can create connector Parts like this, or as one symbol containing many pins, again referencing one PCB footprint. Both methods are detailed below:

In Pulsonix, the Connector can be represented in one of two ways:

- As individual connector pins that can be placed anywhere on the Schematic design, but that refer to the same footprint using up to the maximum number of connector pins for that device e.g. PL1-1, PL1-2 etc.
- The single Connector pin has special properties: it can be selected from the **Insert Connector** dialog and placed anywhere on the Schematic. This means one pin could be used as an input pin on one side of the design, and another could be used on the right side of the design as an output pin.

The second method of using connectors:

- Like a ‘normal’ Component with single or multiple gates to show the Schematic representation, and a PCB footprint. This is less flexible in the Schematic design as the Schematic pins cannot be placed anywhere (unless you define multiple single pin gates). If you want this, create a proper Connector Part.

Both have their uses. For this discussion the Connector Pins will be detailed. If you wish to use a normal Component as a Connector you should follow the chapter for *Creating Parts* later in the manual.

From the **Design Settings** dialog and **Naming**, use the **Display Connector Pin Name** check box is used to decide if you want the pin number to be displayed as part of the Component Name.

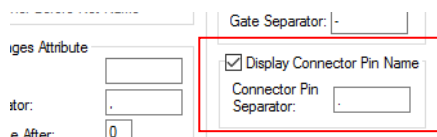

When naming Connector pins, Pulsonix uses the **Connector Pin Separator** character defined in the **Options** and **Designs** dialog to distinguish between the **Connector Name** and the **pin** in the sequence, e.g. PL1-1, PL1-2 etc.

► To add Connector pins

1. Click the **Insert** menu, click the **Connector Pin** option.
2. Select the **Parts library** you wish to use using the **Look In:** drop down list.

- A list of Connector Part Names will appear in the dialog. Only parts that were added to the library, as connectors will be shown. Use the **Filter** to reduce this list to the parts that you are interested in.

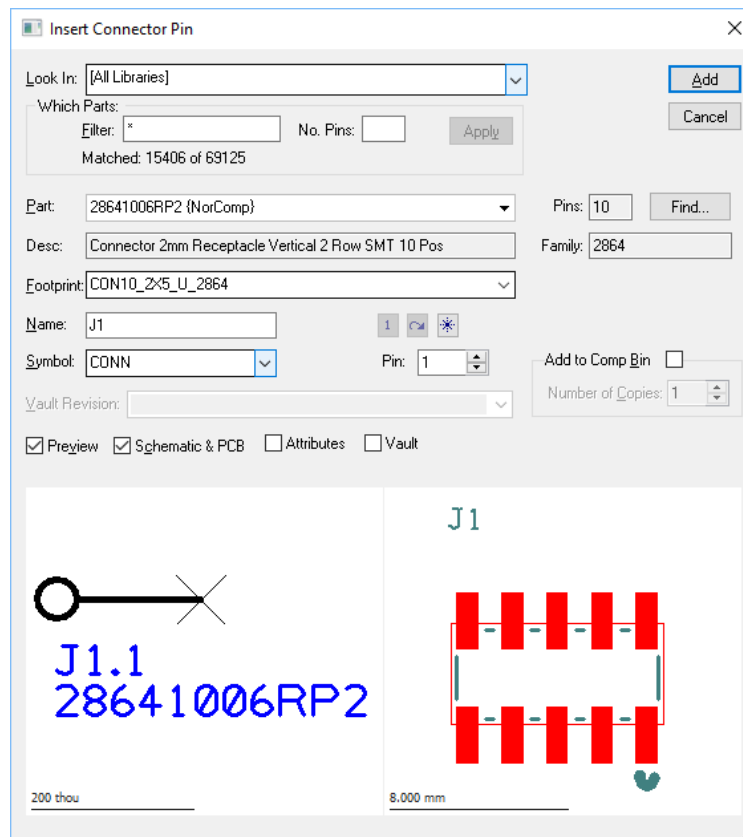

- Choose which connector part you wish to add from the list of **Parts:** using the drop down list.
- Change the pin number you want to add (if the default provided is not suitable) using **Pin:**
- Choose to add the connector (or a number of copies of it) directly to the **Component Bin**, or to add a connector pin interactively into the design using the **Add** button.
- If adding to the **Component Bin**, you are returned immediately to the dialog, else follow these next steps.
- Using the mouse, move the connector pin to the desired position and click to place it into the design.
- Continue to place connector pins using the same Part. Each pin is auto incremented to the next free pin number in the design, or, if all pins of the Component have been added, the Component's name is auto incremented to the next free name in the design.
- Press the <Esc> key, to return to the add connector pin dialog.

You can also insert connectors using the normal Insert component dialog. Check the **Include Connectors** switch to browse your connector parts as well.

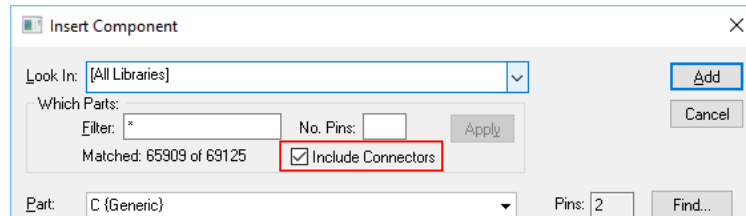

Reloading Parts

Once components have been used into the design, you may need to change the Symbol or the Part definition in the library and then reload it into the design.

You should select the Component you wish to reload. From the context menu you are provided with options to **Reload From Library** (once the Part and/or Symbol has been edited), **Edit Part In Library** and **Edit Symbol In Library** to edit the actual Part or Symbol items.

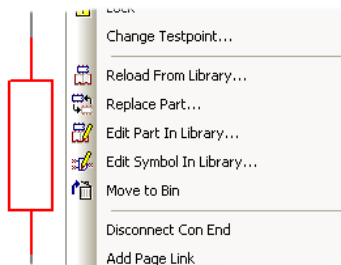

If you select one of the two **Edit** options, you will be automatically placed into the Part or Symbol editor with that particular Part or Symbol loaded from its library ready for editing and saving. You should make your changes and save the updated library item. This is detailed later on in the Chapter on **Library Management**.

Once the Part and/or Symbol item has been changed, you need to then reload it back into the design, effectively 'swapping' out the existing item for the new one.

To do this, use the **Reload From Library** option. With the Component selected in the design, you can use the option from the context menu, or the **Reload From Library** options on the **Utilities** menu.

When Reload is used, all other components in your design using the changed Part or Symbol will also be reloaded. You cannot have two different versions of the same Part or Symbol in a design.

The **Reload From Library** option reveals a control dialog that enables you to selectively choose how the Part will be reloaded. You can choose how items are loaded and which facets within them are retained or overwritten.

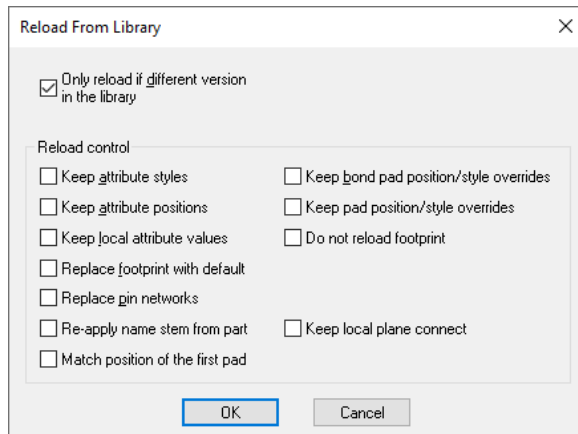

Pressing **OK** takes you to the summary page for confirmation and also the ability to **view a report** of the potential reloads before they are performed.

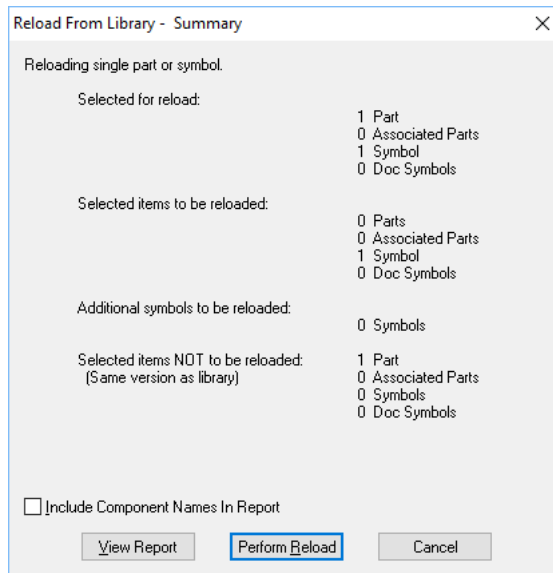

Adding Connections to the Design

Connections are added to the Schematic design to make electrical connectivity between Component, Connector and Documentation Symbol pins. You can add connections to other connections forming junctions. You can also add connections to the design that do not connect to any electrical pins, these are 'dangling' connections and are useful during the design process but should be resolved before the translation to PCB process.

As already demonstrated in the Technology section above, connections hold properties of the Net name and Style. When translated to PCB, all connections using the same net name are joined together to create the netlist from where the PCB is then created.

Information about the connection being added is shown on the Status bar.

Setting up Connection Options

Before any connections are added to the design you should setup the default values used and any predefined Net Names or Net Classes to be used (setting up Net Names and Net Classes has already been discussed in the previous section).

Default **Connection** and **Net** values are set up in the **Design Settings** dialog under **Defaults**.

Connection sets up the **Style** of the connection. This will provide the displayed and plotted width when used in the design.

Net sets up the default **Net Class** that new connections will use during insertion. The **Name Style** will be the default text style used if the **Net Name** is displayed in the design.

Inserting Connections

Once a connection has been started, each single click will add a corner until the destination has been reached. The finish marker F will be displayed and a single click on that pin or electrical 'landing site' will finish it.

Connections can be added to the design in a number of ways:

- Using the Insert Connection option from the Insert menu or from the Schematic Toolbar, click on the pin to start adding a connection, or;
- Double-clicking on a Component pin to start a new connection, or;
- 'Dragging' off an unconnected Component pin to start a new.

***Tip:** If the 'drag off pin' mode is enabled you may find it difficult to move components if you select too close to a pin. To avoid this, select and keep pressed the **Shift** key, and the Component will be selected and moved.*

If you intend adding connections by '**dragging**' off pins you must select the check box this first through the **Options, Select** dialog. If unchecked, a drag moves the Symbol as normal.

<p>Select</p> <p><input checked="" type="checkbox"/> Select Tight Groups</p> <p><input checked="" type="checkbox"/> Minimum Pick Tolerance</p> <p><input checked="" type="checkbox"/> Enable Nudge</p> <p><input type="checkbox"/> Do Not Pick Locked Items</p> <p><input checked="" type="checkbox"/> Select Whole Components</p> <p>Exceptions: <input checked="" type="checkbox"/> Select Component Attributes</p> <p><input checked="" type="checkbox"/> Select Component Pads</p> <p><input checked="" type="checkbox"/> Select From Popup List</p>	<p>Frame Select</p> <p><input type="checkbox"/> Select If Completely Framed</p> <p><input type="checkbox"/> Alt Drag Does Frame Select</p> <p><input type="checkbox"/> Select Error Markers</p> <p><input type="checkbox"/> Select Construction Lines</p>
<p>Drag</p> <p><input checked="" type="checkbox"/> Drag Along Shape Selects Path Between 2 Points</p> <p><input checked="" type="checkbox"/> Drag Unconnected Pin Starts New Connection</p> <p><input type="checkbox"/> Drag From Pin Uses Sketch Mode</p> <p><input checked="" type="checkbox"/> Control Drag Does Duplicate</p> <p><input checked="" type="checkbox"/> Control Drag Sig Ref To Copy Net Name</p>	<p>Double Click</p> <p><input type="checkbox"/> Suppress Properties On Double Click</p> <p><input checked="" type="checkbox"/> Double Click on Attribute to Edit Value</p> <p><input type="checkbox"/> Double Click On Pin Uses Sketch Mode</p>

You can use double-click or drag method to add connections but these are only 'one off and only add a single connection. Once the connection is completed, you are automatically returned back into Select Mode. The **Insert Connection** mode allows you to continue 'stitching' in multiple connections until you exit this mode.

At any point you can change the characteristics of the connection. You can change its **Style**, the **Net Name** and the **Net Class Name**. You can do this while adding the connection or after the connection has been added by editing its **Properties**. These options are available on the context menu or as shortcut keys as pre-defined.

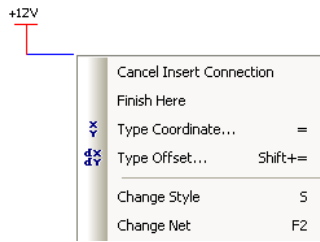

Changing the connection Style

The **Style** of the connection can be changed from that defined in the **Design Settings, Defaults** dialog.

► To change a connection Style

1. While adding the connection right click and select **Style** or press the <S> key on the keyboard.

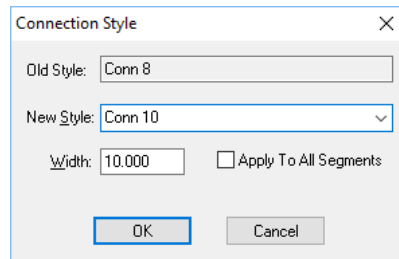

2. Select the **New Style** name from the drop down list, or edit the new **Width** required and type the new style name in.

If the Style name is left blank, you will be prompted with a default name (*style1* or the next available name in the sequence) that will be added to the technology if **OK** is pressed.

The **Apply To All Segments** check box should be used if you wish the style change to be applied to all segments on that connection.

Changing the net name during Insert Connection

While inserting a connection you may wish to change the **Net Name**, this can be done using the **Change Net Name** option from the context menu or by clicking the <F2> key on the keyboard.

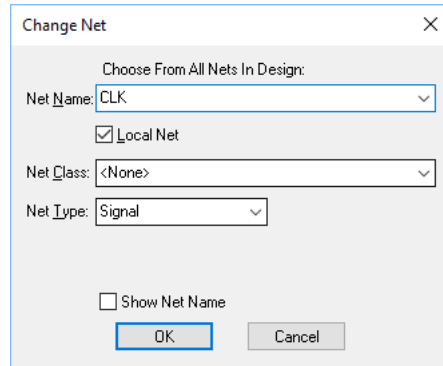

From the dialog displayed you can change the **Net Name** by typing in a new name, or by selecting an existing name from the drop down list. The net names list will contain both Local and non-local (Global) net names.

If you have typed in a new net name, the **Local Net** check box is available. Check this to force the net name to only be used in the current scope. The scope is either all pages in the current block instance or all pages in the design top level (i.e. all pages not in a block instance). Alternatively, make it a non-local net, a **Global** net, (i.e. available to all pages of the design) by unchecking the Local Net box. This might be a net name such as VCC or GND. If the selected net contains items connected to closed busses (i.e. busses that have a closed set of allowed net names, these are explained later on) then the list is limited to just the names allowed.

You can also change the **Net Class** by selecting a name from the drop down list provided it has been defined in your Technology. A Net Class won't be required if you're using **Net Styles**.

Tip: While adding connections, you can press <F2>, followed by the signal name and <Enter>. This will display the Change Net Names dialog, enter the signal name that you type and OK the dialog.

Net Names that are unused in the design but that may have been used previously or typed in incorrectly can only be removed in the **Net Names** page of the **Technology** dialog. By pressing the Delete button on a selected Net Name in this dialog, you can remove it all together. By doing this, you will restore the Net Name to a system default net name using the next in the sequence.

The **Show Net Name** check box can be selected if you wish to display the net name on the net. You can also set this status afterwards using the context menu of a selected net.

Start & ending on different design items

During the insertion of a connection, you can end the connection on a new, single pin design item, as well as any existing electrical pin. This feature can also be used to start a connection on but you must be in **Insert Connection** mode.

During Insert Connection, before starting the connection you can right click to use the **Start Connection On** option from the context menu. After starting the connection you can right click to use the **End Connection On** option on the context menu. You will be presented with the following menu and sub-menu:

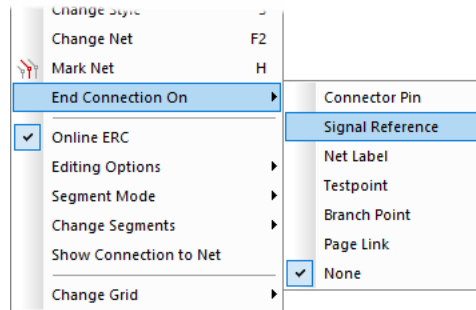

Connector Pin is used to add a PCB Connector pin. This displays the **Insert Connector Pin** dialog to choose the connector Part and which pin number to use.

Signal Reference is used to add a reference to a Net Name. This displays the **Insert Signal Ref** dialog to choose which signal reference Symbol to add. Use this to add symbols to indicate the use of the net, for example, a ground symbol, a cross-page reference, or a sheet label. This displays the **Insert Signal Ref** dialog to choose which Net Label Symbol to add.

Net Label is used for attaching to a net to highlight a particular net.

Testpoint is used to add a Testpoint to the design. This displays the **Insert Doc Symbol** dialog to choose a Documentation Symbol to use for the testpoint (unless a testpoint has already been added to the design that it can copy). A unique testpoint name will be allocated by the system and attached to the Documentation Symbol's pin. Use this to indicate that a testpoint needs to be added to this net when **Translate To PCB** is performed.

Branch Point – if you have the Interactive High Speed option, you will also be able to end a connection on a Branch Point. These are used in conjunction with **Signal Paths** and/or **Sub Nets** to create specific branching points of a net so that additional parameters can be added.

Page Link is used to add an off page connector symbol. This is only available if you have changed the **Net** to be a **global** net, i.e. available to other pages of the design. This first displays the **Insert Doc Symbol** dialog to choose the Documentation Symbol to use (unless this net already has a page link symbol it can copy). Then it displays the **Add Page Link** dialog to choose the page to link to.

None is used when no new item to start/end the connection from is required. This allows you to pick an item from where to start/end the connection.

Once you have chosen an item to start/or end on, it is displayed at the end of the cursor for you to place. Use a single click to place a start item, or a double click to place an end item.

Adding 'Dangling' Connections

A dangling connection in Pulsonix is a connection that starts or finishes in 'free space'. This is perfectly legal and can be useful if you start a connection and cannot decide its destination right now. You can leave it dangling as unconnected at one end until a later stage. Once a connection is dangling, to continue it, double-click on its end (to Edit it), or if using the **Insert Connection** option, select its end and continue with the connection path.

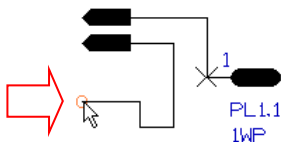

Starting Connections on other electrical points

You can start a connection on other electrical items such as junction points and other connections. However, to do this you cannot use the Drag method, and the Double-click method only works in some instances.

To start a connection on a junction point (the dot that indicates two or more connections connected to each other), you may use the Insert Connection mode or double-click on the junction. From this, a new connection will be started.

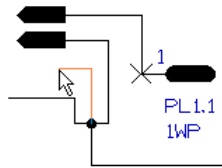

If you wish to start a connection **from a corner** of an existing connection you should use the Insert Connection option or double-click on the corner. The drag method will only move the corner. By starting on a corner of a connection a junction point will automatically be inserted.

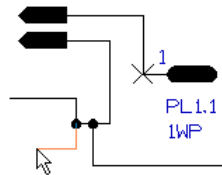

If you wish to **start mid-point** on an existing connection you can only use the Insert Connection method. Attempting to use double-click will edit the connection. Using the Drag method will move the connection segment.

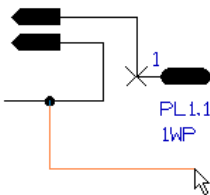

By starting on the middle of a connection a junction point will automatically be inserted.

Changing Segment Modes

While editing connections you can change the 'mode' of segment to enable different 'styles' of editing to take place. For example you can use the **Orthogonal** mode that provides you with two dynamic segments on the connection being edited, or **Angle** that gives you a mitred corner when you change directions.

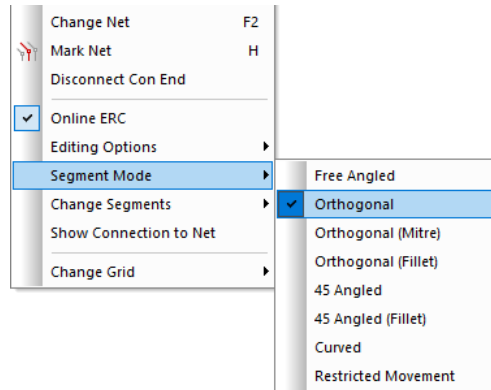

Free enables the connection to be added at any angle, and **Curved** works the same as **Mitre** except that the corner added is curved.

In addition to the Segment modes, you also have the **Editing Options**. These provide you with additional options for use during **Insert Connection**.

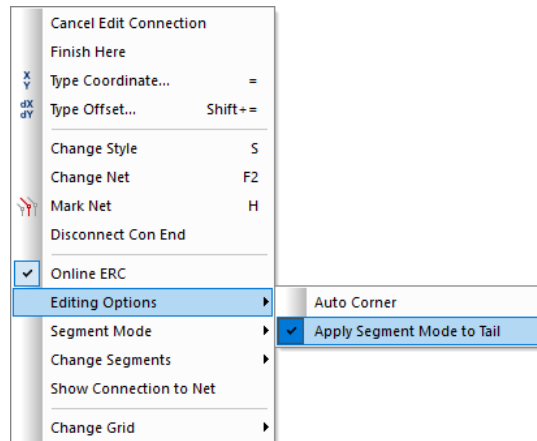

Auto Corner will automatically insert corners when any change of direction is made during Insert Connection. This will use 90 degree corners if the Segment Mode is set to Orthogonal, or Mitred corners if Mitre is set.

If **Auto Mitre** is set, when a change of direction is made, a Mitred corner will be added regardless of what is set in the Segment Mode. The Mitre will be a fixed size using the setting in the **Options, Edit Connection** dialog.

For both the **Segment Mode** and the **Editing Options**, you can either change these while editing or inserting a connection, or before the session using the **Options** and **Edit Connection** dialog.

Segment Mode: Apply Seg Mode to Tail

Interactive Mitre/Fillet Auto Corner

Size: Any Angle Tolerance:

Show 'Can Finish' and 'Has Loop' Markers Remove Loops

Add To Bus Shows Net Name Auto Share Connections

Always Mark Net being edited

Clear Mark when edit complete

Show Connection to Nearest Node

Sketch Connection

Use Point To Point Mode Mitre Result

Use Grid When Sketching Ignore Text

This dialog is also used to set other options related to inserting and editing **Connections**.

Starting a Connection on a Bus

To start a connection from a Bus (Busses are explained in more detail later on in this chapter on *Using Open & Closed Busses*) you must use the **Insert Connection** method. Click on the bus segment you wish to start from and you will be presented with a dialog from where to choose the net name.

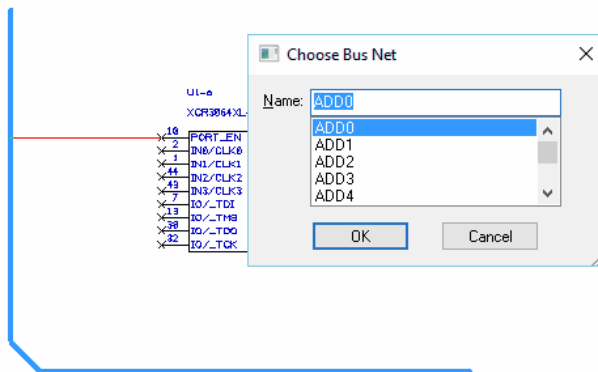

When using **Insert Connection** and adding to a bus, there are rules covering **Open** and **Closed** busses that are adhered to. There are covered in detail in the chapter on *Using Open & Closed Busses* later on.

Showing Junctions over Pins

If two connections are attached to a Component pin, a junction is only drawn if the **Draw Implied Junctions On Pins** check box is checked in the **Options** dialog and **Display**.

The example below shows how the 'implied' terminal would look in the design:

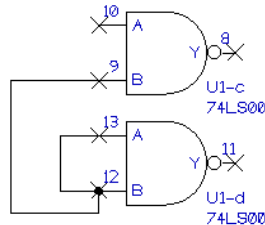

This can be overridden on individual pins if required by selecting the pin and using **Properties**:

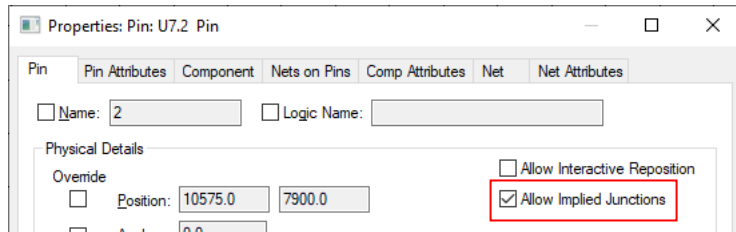

Changing the connection grid

While adding a connection, use the **Change Grid** option to ensure connections are placed on predefined grid points as required. Connections will snap to the **Working Grid** or no grid if the **Use No Grid** option is selected.

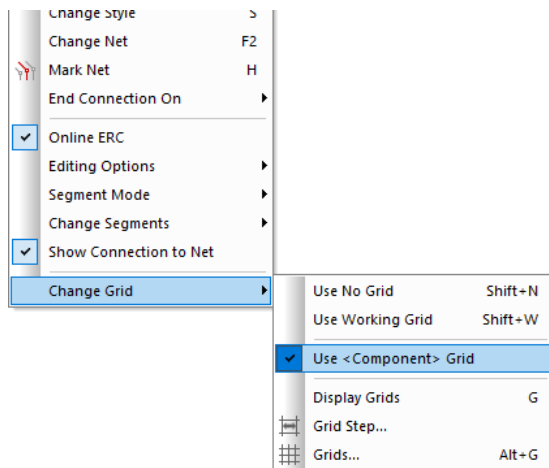

Inserting Components to split a connection

Once a connection has been added to the design, it is possible to move or insert a Component over the connection to split the net. This is useful to add a capacitor or resistor into a section of circuit that already exists.

This situation can only occur with 2 pin components and where the connection is orthogonal horizontally or vertically, the process is automatically exercised once Pulsonix detects this situation.

First the Component is selected or inserted and moved over the connection so that the Component pins are in-line with the connection.

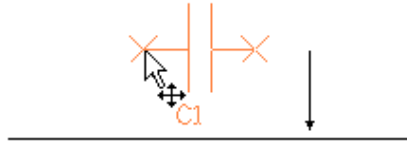

Once the Component has been moved over the connection, the weld markers are displayed (small round blobs):

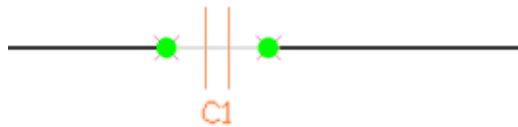

A warning dialog is displayed to show that the net is split into two, with one retaining the original net name (if assigned):

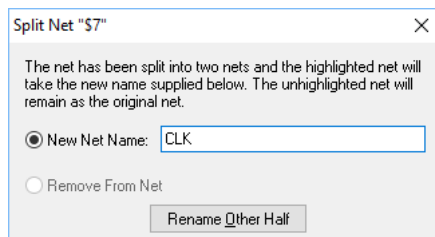

The Component is then dropped in place with the original connection split.

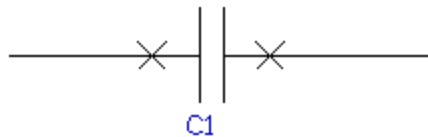

Disconnecting Terminals

If you wish to disconnect a connection and put it on another terminal use the **Disconnect Con End** option. This option is only available when editing a connection and can be found on the context menu.

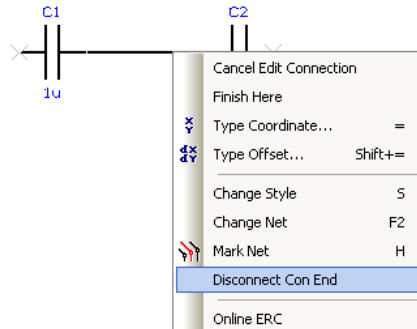

The end that is dynamic for editing will be disconnected when edited. This direction can be changed using the **Reverse Edit Direction** option available on the context menu under the **Change Segments>** option.

Add Connection Modes

Sketch Connection Mode

The Sketch connection path mode is available in the Schematic design editor. This allows you to interactively make a connection between two points using a basic ‘sketching’ mode, or by using a point-to-point mode. This is an alternative method to dragging off terminals or using Add Connection mode.

Using the **Sketch Connection** mode from the **Insert** menu, you can add connections to the design. Once in this mode, this is verified by the display of a modal cursor, a cursor which shows a mode.

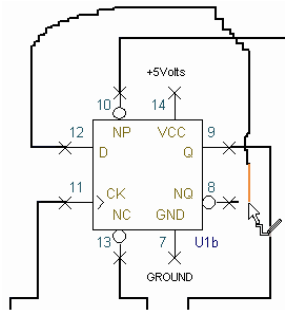

This picture shows the approximate path that you ‘sketch’ in. The modal cursor is also shown.

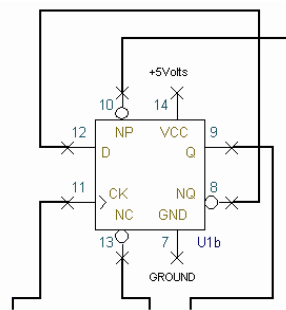

This picture shows the final result after completion and tidy-up.

Immediately after using sketch mode, the tidy routine will snap the connection onto the grid and remove all the rough edges for you. Once added, the connection path can be tidied up using normal connection editing options.

Context menu options

While using the sketch mode, you can select options from the context menu.

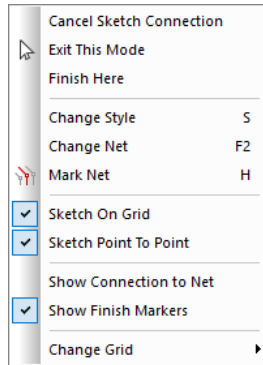

Sketch on Grid should be used if you require the connection to be on grid, this mode is recommended.

On the context menu, you can select **Sketch Point To Point** mode. This allows you to point and click to add a connection path. After the mouse click, the path will be tidied back to the last click, this gives you a ‘guided’ routing path which is automatically tidied as it goes along. This may be a preferred mode of operation to the normal sketch mode.

Sketch modes can be pre-selected from the **Options** dialog and **Edit Connection** page.

Connection Options

The **Options** dialog and **Select** page allows you to use drag or double click to add a connection from a pin on a net with no connection. This is particularly useful for reverse engineered designs. The default is drag to sketch and double click to use normal add connection. The default sketch mode is point to point.

<p>Select</p> <ul style="list-style-type: none"> <input checked="" type="checkbox"/> Select Tight Groups <input checked="" type="checkbox"/> Minimum Pick Tolerance <input checked="" type="checkbox"/> Enable Nudge <input type="checkbox"/> Do Not Pick Locked Items <input checked="" type="checkbox"/> Select Whole Components Exceptions: <input checked="" type="checkbox"/> Select Component Attributes <input checked="" type="checkbox"/> Select Component Pads <input checked="" type="checkbox"/> Select From Popup List 	<p>Frame Select</p> <ul style="list-style-type: none"> <input type="checkbox"/> Select If Completely Framed <input type="checkbox"/> Alt Drag Does Frame Select <input type="checkbox"/> Select Error Markers <input type="checkbox"/> Select Construction Lines
<p>Drag</p> <ul style="list-style-type: none"> <input checked="" type="checkbox"/> Drag Along Shape Selects Path Between 2 Points <input checked="" type="checkbox"/> Drag Unconnected Pin Starts New Connection <input type="checkbox"/> Drag From Pin Uses Sketch Mode <input checked="" type="checkbox"/> Control Drag Does Duplicate <input checked="" type="checkbox"/> Control Drag Sig Ref To Copy Net Name 	<p>Double Click</p> <ul style="list-style-type: none"> <input type="checkbox"/> Suppress Properties On Double Click <input checked="" type="checkbox"/> Double Click on Attribute to Edit Value <input type="checkbox"/> Double Click On Pin Uses Sketch Mode

Naming and Renaming Nets

By default, any connection added to the design will contain a default net name. This name can be changed during the addition of the connection or renamed afterwards.

Using default Net Name properties

Nets have a number of default properties - **Net Name**, **Net Class** and a local state. New Nets will automatically be assigned a default Net Class and made global when added to the design (a global net can be used throughout the design, for example +5V or GND). Nets that have previously been named in the Technology file will already have a Net Class assigned to them, and be marked local or global (local nets are considered to be page specific, for example, on a multi-sheet hierarchical design).

Naming Nets & Renaming Nets

At the addition of connections or the editing of connections you can name them using your own name as an alternative to a system default net name. You can press the <F2> shortcut key this will display the **Change Net Name** dialog. This option is also available on the context menu.

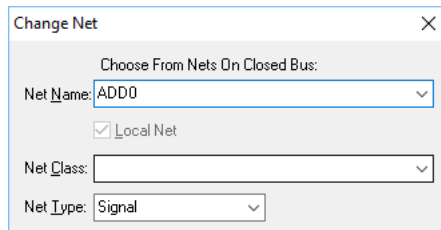

The image shows a dialog box titled "Change Net" with a close button (X) in the top right corner. Inside the dialog, there is a section "Choose From Nets On Closed Bus:" followed by a dropdown menu showing "ADD0". Below this is a checked checkbox labeled "Local Net". Further down is a "Net Class:" dropdown menu which is currently empty. At the bottom is a "Net Type:" dropdown menu showing "Signal".

Local and Global Nets

When designing your Schematic, by default, net names are considered global. That is, even when using multiple pages, everywhere a net name is used, it refers to the same net. Items using the same net name are connected to the same net.

It is possible to define a net name as **local**, which means that only items on the same page can be connected to that net. The **Local Net Names** section of the **Design Settings** tab and **Naming** dialog controls the creation of these local nets, and how their names are generated. This ensures they are unique when producing netlists, or passed forward to PCB. These parameters can only be changed for a new design that doesn't already contain net names or for the Schematic Technology file.

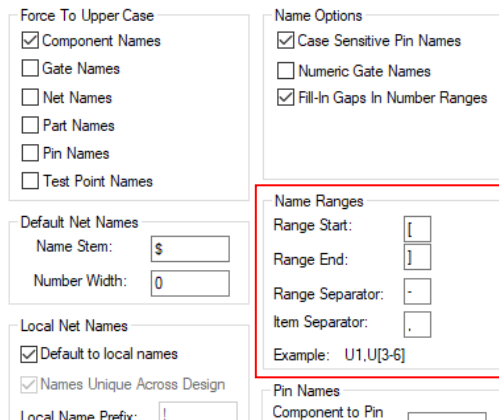

The image shows a portion of the "Design Settings" dialog box. It is divided into several sections:

- Force To Upper Case:** Contains checkboxes for "Component Names" (checked), "Gate Names", "Net Names", "Part Names", "Pin Names", and "Test Point Names".
- Name Options:** Contains checkboxes for "Case Sensitive Pin Names" (checked), "Numeric Gate Names", and "Fill-In Gaps In Number Ranges" (checked).
- Default Net Names:** Includes "Name Stem:" with a text box containing "\$" and "Number Width:" with a text box containing "0".
- Local Net Names:** Includes "Default to local names" (checked), "Names Unique Across Design" (checked), and "Local Name Prefix:" with a text box containing "!".
- Name Ranges:** This section is highlighted with a red box and contains:
 - "Range Start:" with a text box containing "["
 - "Range End:" with a text box containing "]"
 - "Range Separator:" with a text box containing "-"
 - "Item Separator:" with a text box containing "."
 - "Example: U1,U[3-6]"
- Pin Names:** Includes "Component to Pin" with a text box.

Names Unique Across Design, when checked, ensures that the local net name is only used on one page. So if 'Page1' has a local net called 'Net1', 'Page2' could not have any reference to a net called 'Net1'. When this option is unchecked, it is then possible for 'Page2' to also have a net called 'Net1', but it is not the same net and they are not considered connected. Of course when such a design is used in a PCB application these two nets must have unique names. This is where the other controls on the dialog are used. To make the net names unique, the page name is added to them. The way this is done is configurable. You can choose to have the page name before or after the net name, and also have a prefix and infix. In our example, if we chose a Local Name Prefix of '\$\$', a Page Net Separator of '-' with the **Page Before Net Name**, the nets would be named '\$\$Page1-Net1' and '\$\$Page2-Net1'.

If using these options, consideration must also be taken if the design is to contain hierarchical blocks. See the section under *Hierarchy* for more information.

Defining Track & Vias styles in SCM and Translated to PCB

When working with Schematic designs, there are two methods for defining the Track and Via styles in the PCB. The method used depends on how specific you wish to be up-front.

- You can either use a Net Class on a net to create a collective of 'similar' nets that can have a Track and Via style defined, that is, passed into the PCB and use Net Types with the same effect. Net Types can also be used in the same way.
- The second method is to be more specific and to define net or groups of nets with Track & Vias Rules. Rules can be defined generically, such as all nets or ADD*, or very specifically, such as CLK uses XXX rule and SDQ_* uses YYY rule. Once in the PCB (and with the **Design Settings**, **Synchronisation** switch set), defining them in this dialog means they are directly converted in the Schematic into Net Styles in the PCB.

Setting the switch in Design Settings, Synchronisation in the PCB Design

A option in the **Design Settings** option under **Synchronisation** allows **Net Styles in PCB** to be created from the **Track & Via Size Rules** in the Schematic. Use the **Apply Schematic Track & Via Size Rules to Net Styles** switch to enable this feature. Without this switch enabled, this feature will not operate.

The screenshot shows the 'Synchronisation' section of the 'Design Settings' dialog. It contains several options:

- PCB in Safe Mode
- Allow PCB Only single pin nets
- Synchronised Design Name: Name:
- Back Annotation: Enabled
- Synchronise with Schematic:
 - Apply All Rules Strictly
 - Apply Spacing Rules
 - Apply Footprint Changes
 - Apply Net Class Changes
 - Apply Net Colours
 - Apply Schematic Track & Via Size Rules to Net Styles (highlighted with a red box and a red arrow)
 - Apply Schematic Title & Subject
 - Ignore Attribute White Space
 - Allow Update of Schematic to match PCB

This means, where you need to specifically define Track and/or Via Styles in the Schematic, they can be passed through into your PCB where they will be used in **Net Styles**. Both the **Translate To PCB** and **Synchronise Designs** options will use this feature once the switch is set.

If **Translating to PCB** to create the initial design, your PCB Technology used must already have this switch set in order to pass across the settings. Once set, use the **Synchronise Design** option to update the design with these settings.

Design Settings Synchronisation

Once the **Apply Schematic Track & Via Size Rules to Net Styles** switch has been checked in the **PCB Design Settings Synchronise** dialog, you can then define the **Track & Via** styles in your **Schematic** design.

Defining Track & Via Size Rules in the Schematic

From in the **Schematic** design, use the **Technology** dialog and **DFM/DFT Rules – Track & Via Size Limit** dialog. These should be defined in accordance to your requirements. They can be generic such as all **Net Names** in the design, or more refined such as specifically named nets such as DQS*. Other parameters can be selected from the drop-down list as well as **Layers**, **Sides** and **Within Areas**.

These are the rules that will be passed into your PCB design.

Translate to PCB

During **Translate to PCB**, with this switch set in your **PCB Technology** file, this setting will be initially applied to the new design and your **Schematic Track & Via Size Limit Rules** will be defined in the PCB

If the **Track & Via Size Limit Rules** are applied to the PCB, it will add new **Track** styles and a new **Pad Style** to the **Technology**. Two new Track Styles will be created based on the **Min** and **Max Track** width defined. The **Pad** style created will use the **Min** and **Max Via Diameter** to create a pad of the Max diameter size with a drill using the Min Diameter value.

A new **Via Pad** style is added to the **Pad Styles** dialog:

New **Track** styles are added to the **Track Styles** dialog:

	Name	Width
	Signal(8)	8.0
Y	Signal(5.5)	5.5
Y	Signal(9.9)	9.9

Matching settings in the **Net Styles** dialog for the nets requiring them will also be created using the new (or matched) Track and Via Styles.

Electrical Rules Checking (ERC)

ERC Modes of operation

There are two modes of checking the electrical rules; **Online** and **batch** checking. The batch check is more comprehensive and checks all rules set. The online checking option checks a subset of the full batch checking option and is restricted to Pin Types only.

Online ERC

Online rules can be switched on and off in two ways; through the **Options** dialog and **Online ERC**, and by use of the **context menu** during **Insert Connection**.

The Online ERC dialog on the Option dialog allows the mode to be switched on, and then as with Online DRC mode in PCB, allows it to be continuous or enabled **On-Drop** or **After Edit**. You can also opt to **Add an Error Marker** to the design on the detection of an error.

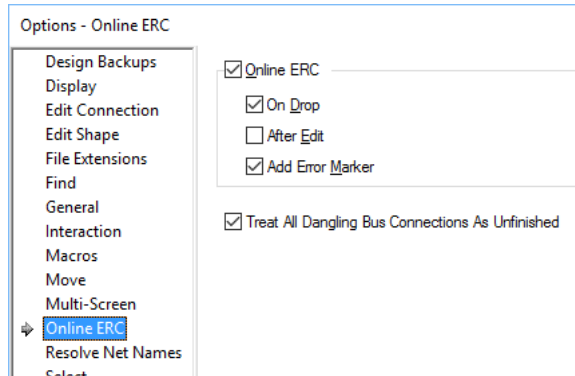

If you check the **Treat All Dangling Bus Connections As Unfinished**, any dangling connections from a bus are flagged as unfinished when running the **Dangling Nets** or **Dangling Connections** checks in the DRC option. With this left unchecked, the check is ignored for these connections.

Electrical Rules Checking Dialog (batch checking)

As well as the **Pin Type Rules** there are also additional rules that can be checked when the **Electrical Rules Checking** option is run.

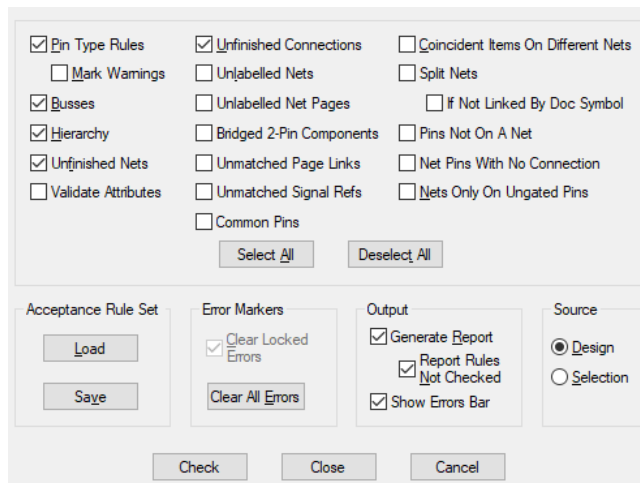

Different rules can be selected for checking in this design. The online ERC option will only check Pin Type rules, the Electrical Rules Checking dialog contains additional rules for batch checking.

Acceptance Rule Set

The electrical rule switches that are shown in this dialog can be saved into the design to form the acceptance rule set. This is the set of rules that should be checked before the design is to be accepted as finished. Use the **Load** button to change the switches in the dialog to the acceptance set in the design, and the **Save** button to change the acceptance set in the design to the switches in the dialog. The summary at the end of the ERC report says if all acceptance checks were checked or not.

Defining the Rules

The **Electrical Rules Checking (ERC)** mechanism allows pin type rules to be set, then checked on components that have been allocated these rules. The checking is carried out using an online option, or the batch option.

The order in which this process works is:

1. Define and add the **Pin Type** to the pin number in the **Part** editor.
2. Define the **Pin Type Rules** in the **Schematic** design or its technology. This is done using the **Pin Types** and **Pin Type Rules** dialogs.
3. Add the Component(s) to the design, these must be components that have **Part** definitions with **Pin Types** defined.
4. Enable the **Online Electrical Rules Checking (ERC)** and start adding connections to the design. Errors found during this process will be displayed, or;
5. Use the **Electrical Rules Checking** option from the **Tools** menu, this is used to check all of the connections and components in the design.

Pin Type Rules

You must set up two items within the **Technology** dialog: **Pin Types** and **Pin Type Rules**. One defines the Pin Type Name and the other defines how each of the Pin Types react with each other.

Pin Types Dialog

The **Pin Type** name is added to the **Pin Types** dialog under **Technology**. By default, Pulsonix is supplied with a list of industry standard names, there are no built-in Pin Types as such but a set predefined for you. Any of the names can be edited but care must be taken if you do this, as the names will potentially not match Part library Pin Type entries. This list also includes any user-defined Pin Types.

	Name	Type	Allow on Block Port
Y	Output		<input checked="" type="checkbox"/>
Y	Input		<input checked="" type="checkbox"/>
	Bi-Directional		<input type="checkbox"/>
	Open Collector		<input type="checkbox"/>
	Or-Tieable		<input type="checkbox"/>
	Tri-State		<input type="checkbox"/>
	Terminator		<input type="checkbox"/>
Y	Power	Power	<input type="checkbox"/>
Y	Ground	Ground	<input type="checkbox"/>
	Open Emitter		<input type="checkbox"/>
Y	No Connect	No Connect	<input type="checkbox"/>
	Passive		<input type="checkbox"/>
	Pcb Connect	Pcb Connect	<input type="checkbox"/>
	Mounting Hole	Mounting Hole	<input type="checkbox"/>
	Ancillary Pad	Ancillary Pad	<input type="checkbox"/>

Use the **New** button to create a new **Pin Type** name.

Any names added can be checked once they have been added to the Pin Type Rules definitions and provided they have been assigned to a pin on a Part.

From the Pin Type dialog you can specify if a Pin Type is power/ground/no connect and if it is allowed on block ports.

When a Pin type is defined as **Power** or **Ground** then when the Part is brought into the design, if the design has more than one net name assigned to any power net classes then a dialog will prompt you

for the net name for which to connect to. A Pin type of **No Connect** will not allow any connection to connect to it.

The **Allow On Block Port** check box allows the Pin type to be used for **Block Ports** and applies block port rules to block ports when using hierarchy. Block instance pins use the normal pin rules.

Pin Type Rules

The **Pin Type Rules** dialog is used to define how the Pin Types will react with each other when connected together. The first column displays a list of all the Pin Types defined (taken from the Pin Types dialog). The second list displays the rule against the corresponding Pin Type, these are colour coded depending on the rule. Any text in **blue** is noting a **Warning Rule** with **Red** noting an **Error Rule**.

A rule can be defined by selecting the Pin Type and clicking the **Edit** button, or by double clicking the Pin Type name.

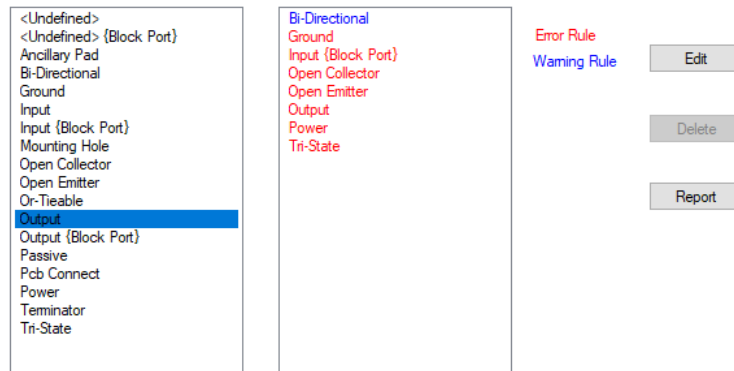

The **Edit** dialog allows single or multiple selections of Pin Types on which to then apply a rule. The **Ignore** status is the default and is shown in the normal text colour, only **Warnings** and **Error** rules are displayed in the appropriate colour.

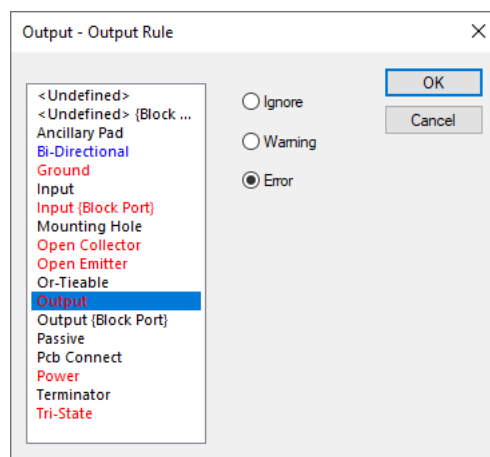

Pin Type Rules can be **reported** using the **Pin Type Rules** report found on the **Output** menu under **Reports**.

An example report looks like this:

<Undefined>	
<Undefined> {Block Port}	
Bi-Directional	
Ground	Warning
Input {Block Port}	Warning
Power	Warning
Output	Warning
Output {Block Port}	Warning
Ground	
Bi-Directional	Warning
Open Collector	Error
Open Emitter	Error
Tri-State	Error
Output	Error

Load Technology Pin Types

The **Load Technology** option will load **Pin Types** and **Pin Type Pair Rules** if required.

The ERC Error Browser

When the design contains error markers (added when the ERC check is run and errors are found), you can show a list of all the markers by displaying the **ERC Error Browser**.

The browser can be invoked when running **ERC** from within the dialog by using the **Show Errors Bar** check box or from the **View** menu or from the **Dockable Views** toolbar.

You can select an error marker in the **Errors Browser** and highlight it in the design.

Viewing Errors

To view an error of a particular type, click on the box next to **ERC Errors**. This will then display all the actual error types found in the design. Click on the box next to the error type that you want to look at. This will then give a list of the pages that have this error. Click on the box next to the page name. This will then list the position of all errors of this type on this page. If you then double click on one of the positions in the list, the view centre of the page will move to this position. The error marker will be drawn in the current highlight colour.

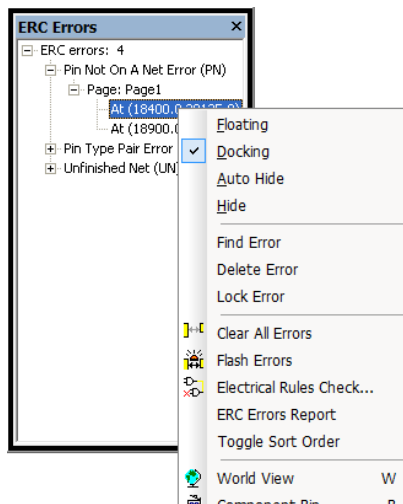

Right clicking inside the ERC Errors Browser will display a context menu. From this there are menu items that allow various complimentary options to be run.

Documentation Symbols

Overview

As the name suggests, **Documentation Symbols** are typically symbols that have no real electrical significance on the design but are used for annotation or documentation purposes.

These symbols could be used for design items such as Testpoints, Power & Ground symbols and Cross Page Link Symbols etc.

The main difference between Documentation Symbols and 'ordinary' Symbols is that they have no Part definition, and they reside in their own Documentation Symbol library. Most importantly, most Documentation Symbols are not transferred to the PCB design when using **Translate To PCB** or appear in any Parts Lists created. There are a couple of exceptions in that Testpoints and Mounting Holes are transferred to PCB.

Schematic Documentation Symbols are used for several purposes. It is therefore necessary to specify the purpose of each symbol when it is created. In this way, the program can ensure that the symbol satisfies the requirements of its purpose (for example that it contains exactly one pin) and that you are only presented with symbols of the correct type when adding them.

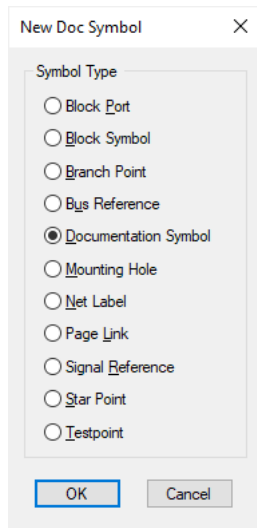

There are a number of documentation symbol types:

Block Port is used within a block to connect with the enclosing level. It is a terminal used to connect between hierarchical levels. A block port symbol must have a single pin, and can contain any shapes you wish. To add a block port, use the **Insert Block Port** command.

Block Symbol is used to represent a block instance. When you create a block, you can nominate a block symbol to represent that block. You can also choose the symbol when inserting a block. A block symbol must have a pin for each Port in the block it is to represent.

Branch Point is a symbol used with the high speed option to create 'branches' within a net so that specific rules can be defined using **Signal Paths** and/or **Sub Nets**.

Bus Reference is a symbol used to display the nets range on a bus. The symbol must contain a single pin. Whilst adding a bus, use **End Connection On** from the context menu.

Documentation Symbol can be used in many ways. For example, it could contain a logo. You can add a documentation symbol to a design by using the Insert Documentation Symbol command.

Mouting Hole can be defined in the Schematic so that it can be assigned a net name when passed through to the PCB.

Net Label are attached to nets to highlight the net name. These can be formatted with shaped and coloured boxes.

Page Link is a symbol to represent a link to another page. When this symbol is used, it can be associated with another page in the schematic. You can then 'jump' to the specified page using the Jump to Page command, when the symbol is selected. Whilst adding a connection, use **End/Start Connection On** from the context menu.

Signal Reference is a symbol used to represent a break or link on the net. The symbol must contain a single pin. It would typically be used for a ground or power symbol. Whilst adding a connection, use **End Connection On** from the context menu.

Star Point is a symbol used when multiple nets containing different names are to be connected together at a common point.

Testpoint is a symbol used to represent a testpoint. The symbol must contain a single pin. Testpoints can be added using the Insert Testpoint command. Whilst adding a connection, use **End Connection On** from the context menu.

Using 'general' Doc Symbols

Documentation Symbols can contain any documentation shapes, electrical pins, text and attributes. They can be created or edited using the Schematic Documentation Symbol editor. These would be used for general documentation purposes, such as drawing borders, drafting notices etc. They are not used for electrical notation such as power and ground labels.

You should add Documentation Symbols from the library to the design using the **Insert Documentation Symbol** option.

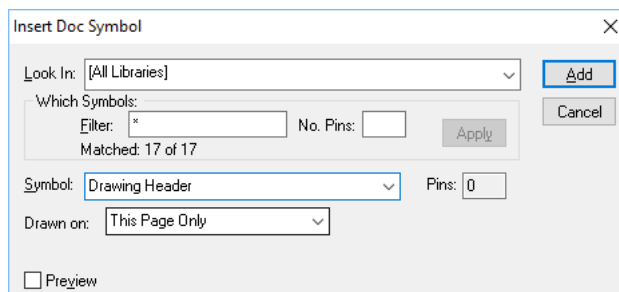

This dialog uses standard Pulsonix functionality.

- Set the Documentation Symbol library you wish to add from (**Look In**). A list of Symbol names will appear in the dialog. Use the filter to reduce this list to the Symbols that you are interested in.
- **Filter** the name and/or the **Number of Pins** to refine the list.
- Choose the Documentation **Symbol** you wish to add from the list.
- From the drop down list, select the Page or pages you wish the symbol to be **Drawn On**.

The **Preview** check box allows you to preview the symbol before it is added to the design.

The **Add** button will dismiss the dialog from view and will allow you to interactively add as many Documentation Symbols of the type selected as you like to the design. If you require a **different Symbol** you should cancel this process by pressing the <Esc> key on the keyboard. This will immediately return you to the Insert Documentation Symbol dialog from where you can make further Symbol selections. If you wish to **cancel Insert Documentation Symbol** completely, having finished this process, or use the **Cancel** button from the dialog.

Using Doc Symbols

Like components in the design, they can be selected and the symbol from the library edited using the context menu. If modified in the library and already used in the design, they should be reloaded using the **Reload from Library** option from the context menu, or the **Reload** options on the **Utilities** menu.

Doc Symbols can be placed in to the Component Bin for use at a later stage.

When using Doc Symbols in the design they can be connected to and added directly onto a connection by releasing it on the connection itself.

Using the Next and Previous Symbol option

When adding Doc Symbols, from the context menu, you can select **Next Symbol** and **Previous Symbol**. This will select the next (or previous) symbol in the list displayed in the Insert dialog. Any filters created will also be applied.

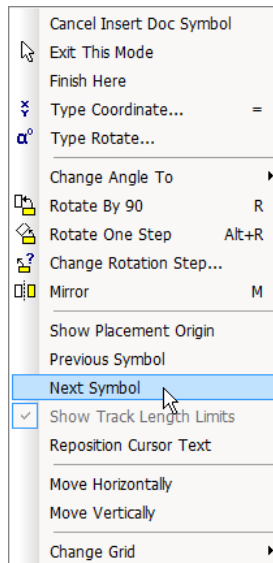

Block Ports

These Doc Symbol types relate to hierarchical block use and are used to indicate lower level block connections to the upper level.

Block Ports are added to the design using **Insert Block Port** and are only available if the system detects that you are on the correct level of hierarchy. When creating Block Ports, the Pin Name attribute is predefined for use. Shapes can be added to the symbol to annotate it.

The use of these Doc Symbols is described further in the section on Hierarchy.

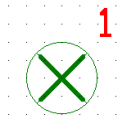

Block Symbols

Block Symbols are used to represent hierarchical blocks that have been saved.

When creating these Doc Symbol types the **Block Name** and **Block Instance Names** are added by default.

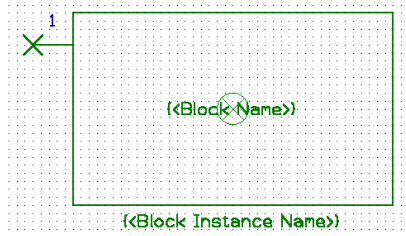

You can add any number of pins to represent the connections to the lower level circuitry. These will be available for selection for use during **Insert Block Instance**, **Properties** and **Change Block**.

Block Port and Blocks

These are discussed under the *Hierarchy* section below.

Branch Points

Branch Points are added to the design using the **Insert Signal Reference** option. These are connected to a net to indicate the point at which a Signal Path or Sub Net would be defined to/from. These are used when using the High Speed Design option and will be available when you have this license feature.

The illustration below shows how a branch point may be connected as an integral facet of the net (Branch 1) or as an isolated standalone item (Branch 2):

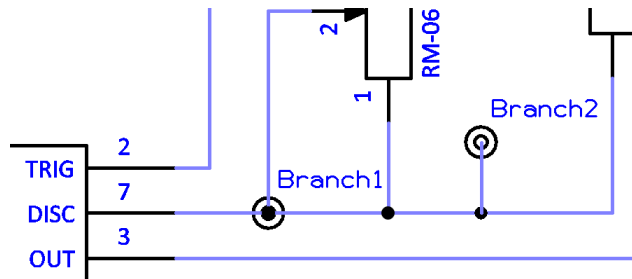

Once these have been added you can then create a Signal Path or Sub Net to which these can be referenced. They do not form and part of a net other than an indicator to a branch. These points are translated to PCB when they can be positions.

Bus References

Bus References are similar to signal references and can be added to Schematic designs via the new menu command **Insert Bus Reference**. These are attached to buses and used to label the bus. They display the nets within the bus.

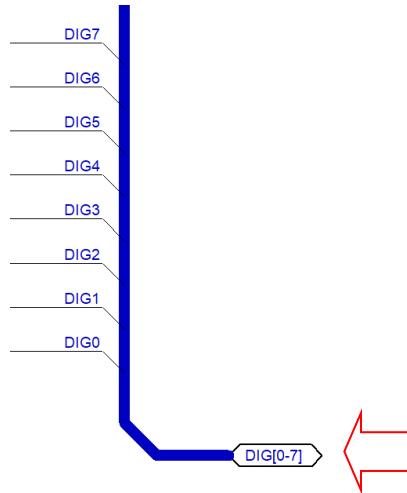

A bus can be started and ended on a Bus Reference. This can be configured within the symbol to display various details of a bus, for example, the Net Name.

Documentation Symbols

Documentation symbols in a schematic are used for adding additional information without the information being passed to the PCB or appearing on a bill of materials (BOM) or having any other significant electrical meaning. This might include drawing borders or special drawing/drafting information such as WEEE or Static symbols.

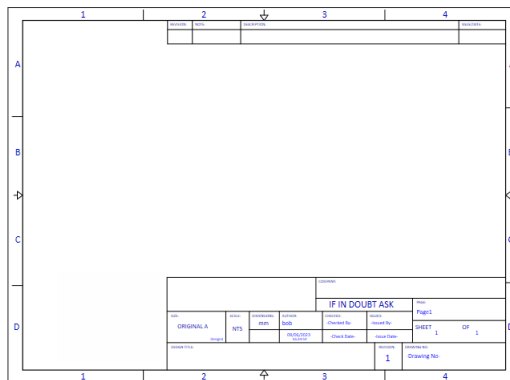

Mounting Holes

When used, Mounting Hole Doc Symbols can be added to an existing net to enable their net connectivity in your PCB design. They might contain a Pin plus a Net Name attribute and some documentation outline as required.

Following successful **Translation to PCB**, Mounting Holes are added to the **PCB** using the **Mounting Holes** setting in the **Design Settings, Defaults** page. This setting will select the layer for the Mounting Hole and Pad Style used.

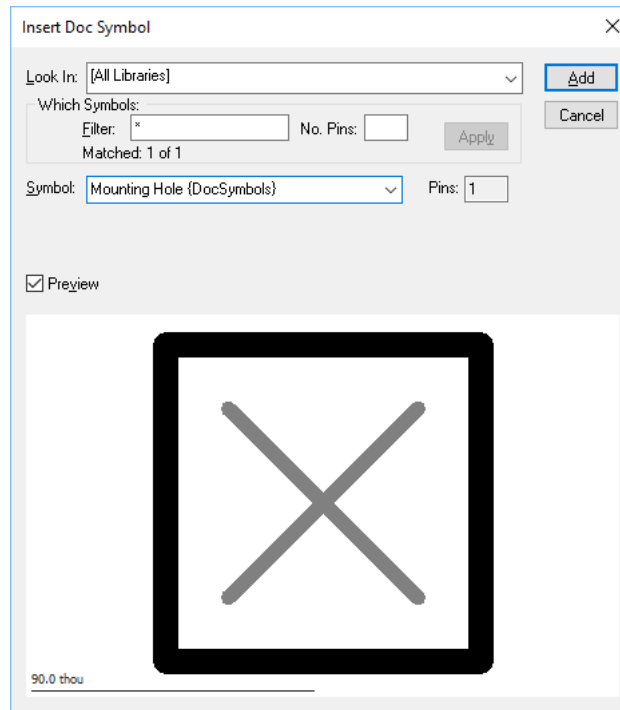

Net Labels

Net Labels are used to 'hang' on a net to explicitly show the net name on your Schematic design. Because it uses a special Doc symbol, it means you can customise how it looks and where it is attached to. The symbol's net name is dynamic and will update as the name changes.

On creation, the symbol will contain a **Pin** and an attached **Callout** with the **Net Name attribute** stored in the callout.

You can add net labels by using the **Insert Signal Reference** and selecting the **Type** as **All** or **Net Label**.

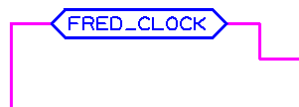

Page Link

In Pulsonix, a Schematics design can consist of multiple pages, each representing a separate sheet of the final schematic. You can add links between these pages enabling a page to refer to another page. These links enable you to easily switch the current page you are editing to the page referred to.

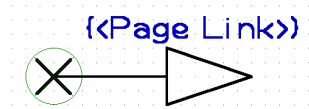

Page Links are added through the **Insert Signal Reference** dialog. During creation, the {Page Link} and {Net Name} attributes are added along with a pin. When added to your design, it will ask you to provide the page that the link refers to.

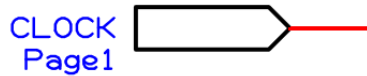
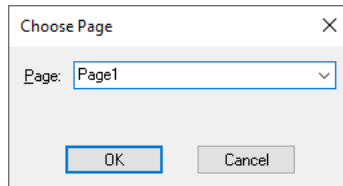

Page links are often used to join a global net connection leaving one sheet and entering another. These are for documentation purposes only as all parts of a global net are always connected together when creating a PCB design from the Schematic.

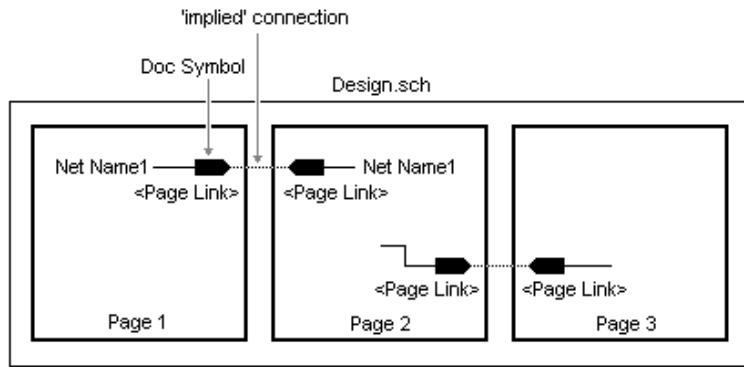

Adding Page Links

Pulsonix page linking is performed using the special **<Page Link>** attribute. The attribute's value is the name of the page that the link refers to. Double clicking the mouse when the cursor is over one of these attributes will change the page currently being edited to the page the link refers to. This way you can use the mouse to easily traverse the schematic's pages. There are two ways of adding a page link attribute; using the **Insert Attribute** option and the **Insert Page Link** option.

► To add a page link

1. Select the item you wish to add the link to, or select nothing if the link is to be added to the schematic's page itself. Right click the mouse to use the **Add Page Link** option from the context menu. Choose from a list of names of the pages in the schematic, or type the name of a future page to be linked to. The attribute will then be added.

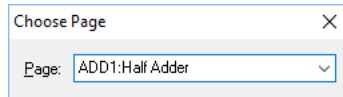

2. The page link attribute may be visible, in which case you can use it directly to switch pages as mentioned above, or it may be left invisible. If invisible, selecting the item the page link is on will allow switching pages using the context menu.

Interacting With Page Links

► To use page links

1. Double click on a **visible page link attribute name** to switch pages, if the named page exists.
2. Select the page link attribute, or the item the attribute is on and right click the mouse to use the context menu.
3. Use **Jump To Page** to switch to the page referred to.
4. Use **Change Page Link** to alter the name of the page the link refers to, or to change the visibility of the **<Page Link>** attribute.
5. With nothing selected, right click the mouse to use the context menu. If this page is itself linked to another page you will be able to use **Jump To Page** and **Change Page Link**, mentioned in the previous section.

When To Use Page Links

Documentation References

Often the sheet outline title block contains lists of the names of the other pages that make up the design. Adding these names as page link attributes means you can also use them to switch pages.

Cross Page Signal References

Where separate pages are simply used to split up a complex design, you have the situation where a connection leaves one page and enters another. This is usually done by ending the connection on a symbol that represents an off- page connector, with the name of the page it is going to next to it. Pulsonix handles this by ending the connection on a single pin documentation symbol that has a page link attribute. The advantage of this is you can actually use these symbols to switch to the page that the connection is going to.

To make it easier to do this, when adding connections on global nets, you can right click the mouse to use the context menu to start, or end, the connection on a page link symbol. You simply have to choose the name of the symbol to use and the name of the page to link to and an off page link will be dropped into the design.

Signal References

Signal References can be used for a number of purposes but effectively they all have the same effect, that of adding additional documentation to your schematic. They can take the form of cross sheet signal references, power & ground symbols or simple signal references.

The **Insert Signal Reference** dialog from the Insert menu allows you to add any of the categorised documentation symbol types and add them to your design. By using the **Type** drop down list, the Sig Refs will be presented in the Symbol list using their category. You can use **All** to present all documentation symbols regardless of category. Categories for these symbols would have been specified during their creation using the **New** dialog or when saving to the library.

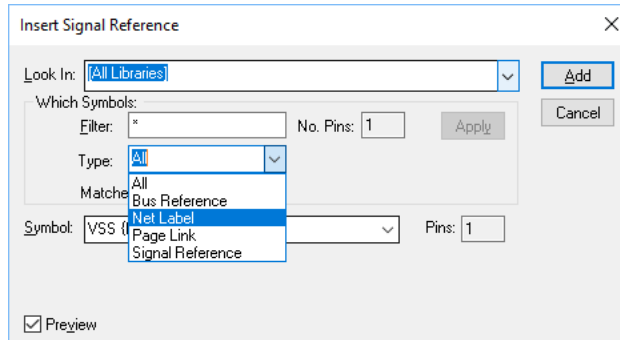

Other special doc symbols, such as Doc Symbols, Testpoints, Branch Points, Mounting Holes, Blocks, Block Ports and Star Points are all handled from their own Insert dialogs.

Reassigning Sig Ref Symbols for other use

Existing Sig Ref symbols already in the library can be re-categorised by editing them and using the **Symbol Properties** dialog from the **Edit** menu or by using **Save To Library** and choosing the new type from the list:

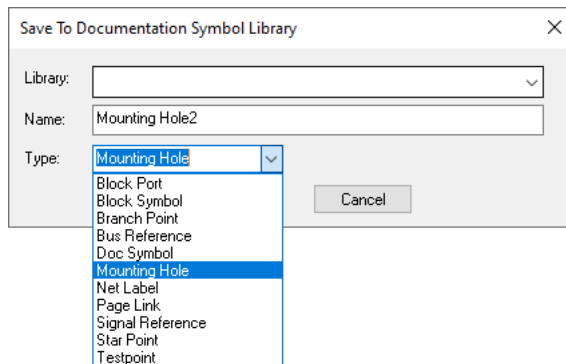

Power and Ground Symbols

Power and ground symbols are often required in the Schematic to indicate a connection to a power source. These symbols are required for aesthetic purposes and are not translated to the PCB. The signals they represent are connected together at the translate stage by 'implied' connectivity.

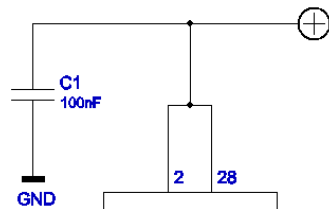

The power and ground symbols themselves can contain inherent net name properties that are automatically used when the Symbol is attached to the net.

Nets that are invisible in the design but that provide connectivity are generally referred to as 'implied nets' because they are not directly visible but are translated to the PCB design where they become connected together using their net names.

When creating Signal Reference symbols for use with power and ground nets you can be specific or semi-specific in your use of the Net Class and Net Name matching that will be used in the design.

When in the Doc Symbol editor you can select the **Symbol Pin** and right click to get its **Properties**. From this dialog you can opt to automatically **Connect To Net** when it is used in the design.

Connect To Net allows you to specify that the pin should connect to a net of the given net class type (**Power**, **Ground** or **Signal**, or to a given **Net Name**). This is useful, for example, if you wish to create a ground symbol that should obviously be connected to a **Ground** net. If the design only contains a single net of the appropriate type, the symbol will be automatically connected to it. If there is more than one net, a dialog offers you the choice. If there is no such net, a dialog offers you the option of creating one. Similarly, for a given net name, if the net exists, the pin is automatically connected.

You can Connect To Net, provide the Net Type and/or Net Name.

► To add Power/Ground symbols

1. From the **Insert** menu click **Insert Signal Ref**
2. From **Type:** select **Signal Reference** from the drop down list
3. From the **Symbol** name drop down list, select the Symbol required
4. Once the Doc Symbol is dynamic on the end of your cursor, you can position it over a net.
5. When released a dialog is displayed (if applicable):

If only a Net Class Type has been specified when the symbol was created when you add the Symbol it will automatically connect to the ground or power net in the design unless there is a choice, in which case you are prompted to select one.

6. From this dialog, select the **Net Name** for the Doc Symbol.
7. The Net being connected to will now take on the net name specified. If the Net already has a name, a warning dialog will be displayed requesting the net name to use.

Cross Sheet References

The principle described above for power and ground symbols also applies to normal signal references used for inter-sheet or cross sheet notation. The main exception is that the pin used in the symbol has no predefined Type or Net Name. The Net Name is applied to the pin when used.

When creating Signal References in the Doc Symbol editor, the Net Name attribute is predefined for your use.

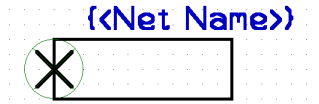

A Signal Reference in the Schematic might look like this:

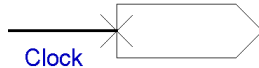

Star Points

Star Points or Delta Points as they are sometimes called, allow you to connect multiple named nets together at a common point. This might be the GND and Digital_GND nets for example, where they have the same input point but need to be isolated from each other except for the source point.

Star points are used in both Schematic and PCB designs and are recognised by Translate to PCB and Synchronise Designs.

The process of using star points in Schematics is straightforward. The Doc Symbol is defined as being a **Star Point** type. This can have any number of terminals but the nets connecting to them remain independent regardless of whether a single terminal or multiple terminals have been defined.

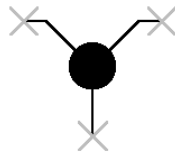

When translated to the PCB design, the first segment of the tracks only will not cause DRC violations with each other. It is also recommended that in PCB you have the switch **Allow Single Pin PCB Nets** set to off.

Testpoints

As with Signal References, Testpoint symbols are very basic. During creation in the doc Symbol editor, the Testpoint Name attribute is pre-selected for use.



These will be used when the Insert Testpoint option is selected and when a connection is selected to end or start on a Testpoint.

Using Busses

A bus is a shape that represents a collection of signals on the schematic design. This makes the schematic less cluttered as many parallel connections running from one side of the drawing to the other will not be required. You can add a connection from an electrical pin to the bus that carries the required signal.

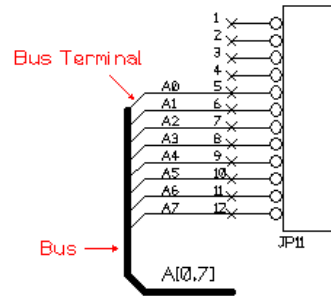

Closed Busses

A newly added bus is **Open** to carry **any** net names. You can **Close** it to only carry a closed set of allowed names by selecting it and using Properties from the **Edit** menu.

Once closed, you can only add a connection to the bus if the connection is on one of the nets defined in the bus's set of net names. When trying to connect to a closed bus, you will be presented with a list of the bus's net names to choose from.

The set of allowed net names can be displayed next to the bus using a condensed range format. Select the bus and right click to use **Show Net Name** from the context menu. Then drag the name range to the desired position.

Bus Terminals

When a connection is attached to a bus segment, the end of the connection is bent at 45 degrees as it touches the bus. This 45 degree segment is known as a **Bus Terminal**. The Bus Terminal takes its colour and width from the Connection, but it is not part of the connection.

To set the default Bus Terminal length use **Design Settings** and the **Defaults** tab and change the bus terminal offset to the required value, and also its exit direction from the bus, **Up** (or **Down** unchecked) on vertical bus segments and **Right** (or **Left** unchecked) on horizontal bus segments.

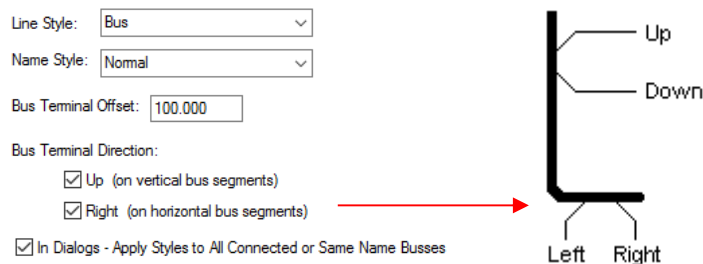

The bus terminal may not be initially added in the preferred direction, to alter this select it and use the **Rotate** option to **Flip** between the allowed angles.

When the connection segment attached to the bus terminal is moved, the bus terminal moves with it to the nearest place on the bus. When the bus segment is moved all bus terminals attached to it are moved with it to keep the bus together.

The net name can be displayed next to the bus terminal. Select the bus terminal and right click to use **Show Net Name** from the context menu. Then drag the name to the desired position. Use the **Options** and **Interaction** tab to enable automatic display of net name when connecting to a bus.

When a connection to a bus is deleted, the bus terminal is also deleted.

Bus References

A **Bus Reference Doc Symbol** can be added to a bus to indicate its use or for documenting the nets it contains.

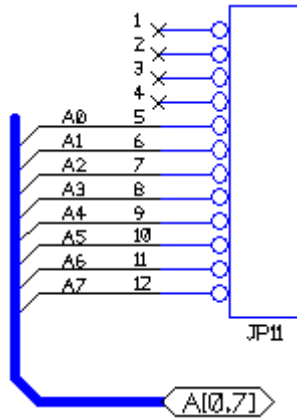

Translate To PCB

Busses are not important when translating to PCB; they are simply a way of simplifying the Schematic using an annotation for multiple nets. All items connected to a bus will be joined to any other items on nets of the same name.

► To insert a bus

1. Before entering **Insert Bus**, select another existing bus if you want to create a bus with the same line width and allowed net name set.
2. Click the **Insert** menu and click **Bus**.
3. Click to pick the start position, and click to add each corner. Double-click the mouse button to finish.
4. If required use Properties to add or change the allowed net names to the bus.

Changing Net Names on a Bus

The **Bus** tab is available when using the Properties option on one or more selected bus segment(s). You should use this to change the selected bus line style and allowed nets.

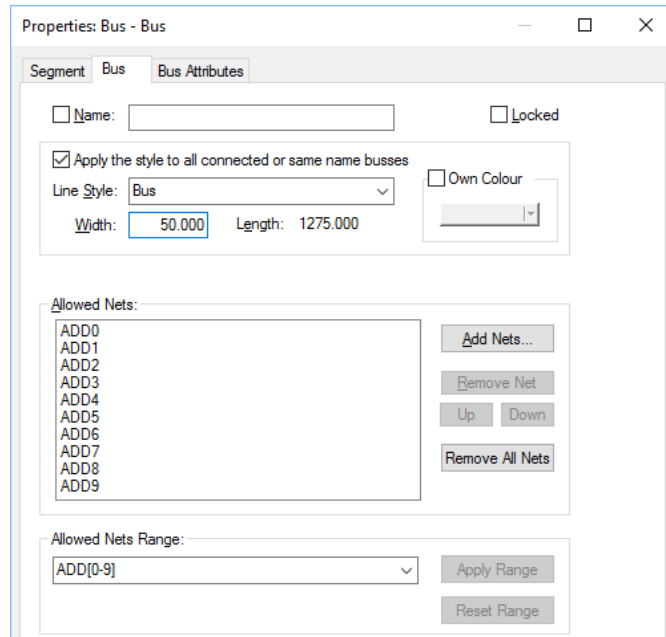

Locked is used to lock the bus from future editing or moving. Once the bus is in its final position, lock it to avoid accidentally altering it.

Choose the required **Line Style** for the bus from the list of line styles already defined in the design. These can be altered using the **Technology** option from the **Setup** menu. The width for the selected style will be shown in the edit box.

If you don't know the name of the style then type the required line width in the **Width** edit box. The style that matches the typed line width will be selected from the list. If no line style in the design matches the typed width then the line style name box will be left blank. Type the new name for the line style, or leave blank for the system to assign a default name for you.

Listed here are the **Allowed Net Names** that represent the signals that the bus can carry. If any net names are listed the bus is **Closed**, so only the listed nets can be connected to the bus. If there are no names listed the bus is **Open**, so any net can be connected to it.

Add Net is used to add some net names to the closed bus. It displays the **Add Net To Bus** dialog that allows you to select from net names already in the design, or add your own new net names (see below on how to do this). If the bus was open (i.e. no names listed), and it has nets already connected to it then you will be asked to add these nets to the list automatically. If the bus has default named nets connected to it (e.g. N0001) you cannot turn it into a closed bus.

Remove Net is used to remove the selected net name from the Allowed Nets list. You cannot remove names of nets that are already connected to the bus.

Remove All Nets is used to turn a closed bus into an open bus by removing all of the net names from the Allowed Nets list.

Allowed Nets Range initially displays the list of **Allowed Nets** in range format. This is the string you would see if you displayed the net name on the bus. Details of the range format are shown in the next section on *Decoupling Capacitors*.

You can use this to type in the required closed bus nets directly in range format or select from a list of name ranges used on other busses in the design. If the text is changed the Apply Range and Reset

Range buttons are available. **Apply Range** allows you to apply the changed string to the Allowed Nets list. **Reset Range** resets the string to match the current names in the Allowed Nets list.

► To add net names to a bus

1. From the **Bus Properties** dialog, click the **Add Net** button. This dialog is used to specify the net names are allowed on the closed bus. Only connections on those nets can be attached to the bus.

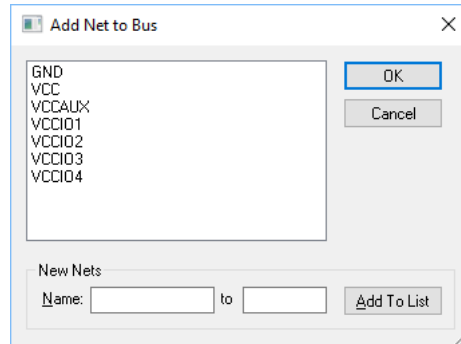

2. This lists all the named nets that exist in the schematics design that are either global or local to the page that the bus is on. Select one or more net names from the list that you want to add to the bus.
3. If you want to add new net names to the bus that are not in the list, use the New Nets box at the bottom of the dialog. Type the name of the new net into the Name: box. If adding a range of net names, type the first name into the **Name:** box and the last name in the range into the **to:** box.
4. Click **Add To List** to add the new net names to the above list. These names are selected ready to add to the bus. Note: New net names added using this method are always added to the design as global nets. If you want to change them to local nets, use the **Technology** dialog and **Net Names** facility.
5. When you have selected the names, use **OK** to add these names to the allowed net names list on the bus.

Auto-weld Connections to a Bus

You can also drag a Component in the Schematic design so that when the pins of the Symbol are over a bus segment it will weld it to the bus.

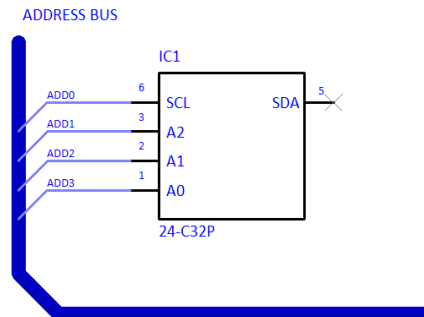

For Closed Buses

Move a Component or Gate (Symbol) so that the pins are coincident with the bus, ensure the pin grids and bus grid are the same:

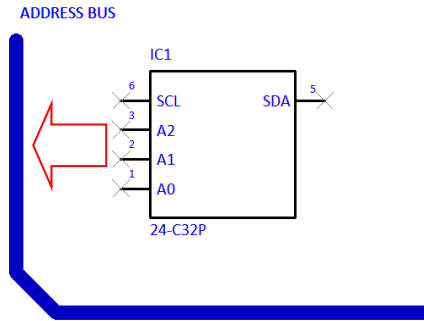

Weld Markers between the bus and Component pins are displayed indicating the component can be welded:

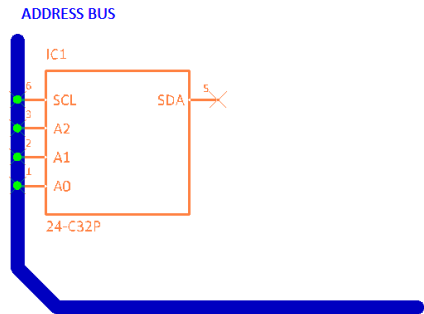

When a bus is closed (i.e. with named nets), a dialog will be presented to choose the net names from the bus for each of the pins:

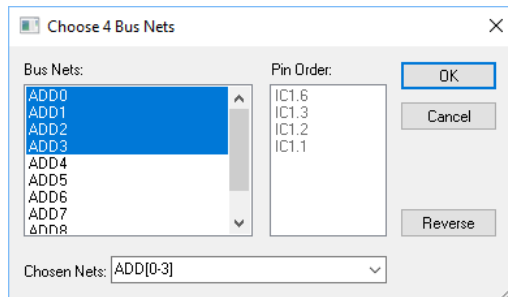

When choosing nets to add to the pins, it will always select the first matching number of nets/pins. However, the Bus Nets can be individually changed by picking them from the list, the Shift and Ctrl keys can also be used to aid selection.

Moving the symbol away from the bus will show the connections and bus terminals clearly.

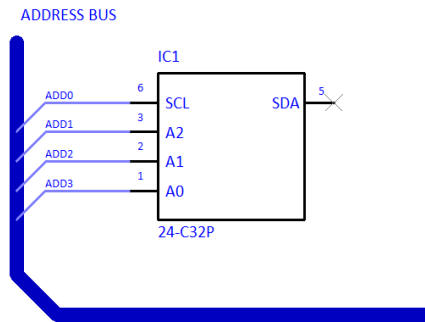

Open Bus

If the bus is an open bus you cannot pick from net names on bus, but can type the required net name range (or pick an existing closed bus name range from a drop down list).

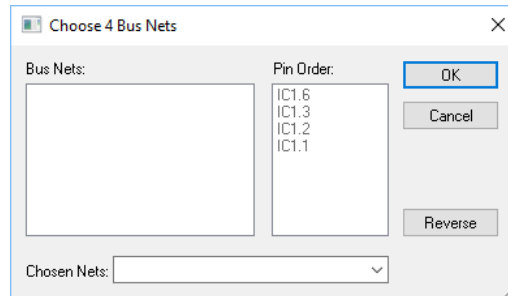

If other closed buses are defined within the design, you can choose the nets using the drop down list using **Chosen Nets**:

Bus Names in PCB

Bus Net Names are translated to the PCB and can be used in options that have an interest in them, such as the **Bus Routing** option. These can be used to easily select bus net names for bus routing. More information about this function can be found in the Online Help *Bus Routing Usage*.

Hierarchy

What is hierarchy and why use it?

Hierarchy in Pulsonix is the ability to add ‘blocks’ to a design that in-turn can contain circuitry. Blocks are simply shapes that represent a lower level of the design, these are often used to declutter the schematic or to reuse existing blocks of know good circuitry.

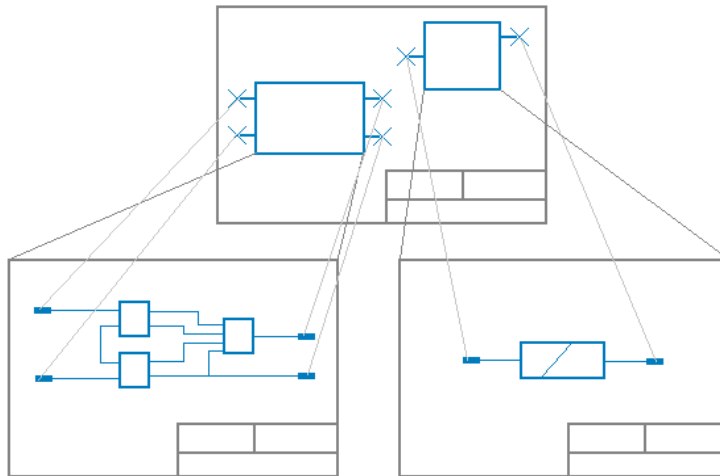

There are two, not unrelated, reasons for using hierarchy.

- To allow a schematic design to be structured, so that it can be broken down into its functional elements. This promotes Top Down design; break down a problem into functional elements, then define the detail of each element.
- To facilitate the re-use of commonly used circuit elements. This promotes Bottom Up design; use predefined elements to build a solution.

In practice, you may want to use a combination of both Top Down and Bottom Up design.

Overview of Hierarchy

Blocks

A block should be a functional element that has a well-defined purpose and interface. In design terms, a block is a special schematic design that describes the implementation of its function; it also has a symbol associated with it that represents the interface.

A block can be instantiated in a schematic design (or another schematic block design). The symbol representing the block is placed in the circuit, and can be connected to, in a similar way to a component. However, as well as the symbol being added to the design, all the pages of the block design are also added. Component and net names are resolved so that there are no conflicts. Connecting to the symbol pins joins the nets with those defined in the block instance.

In many respects, a hierarchical schematic design is no different to a normal multi page design. The net lists would be the same, and the drawings are largely the same. However, it is easier to navigate, because you can **Push** into the pages representing the block instance, from its symbol, and **Pop** out of the block instance, back to the symbol. It is also possible to update the contents of a block instance, from the original block design.

Top Down Design

To work top down, that is, from an ‘upper’ level schematic sheet, you can add an existing block or generated a block instance for each part of the design that is, as yet, undefined. At a later stage, you can **Push** into the block instance to edit or define its circuit. From the top level, you can then connect to the block instance using **Insert Connection** (or **Insert Bus**), either connecting to an existing pin on the block symbol, or adding a new one by clicking anywhere on the symbol outline.

Bottom Up Design

You may want to create libraries of commonly used blocks, such as power supplies or signal converters. You can do this by taking an existing Schematic design and creating a Schematic Hierarchy block design from it. This is saved into one of the nominated Schematic block folders. When creating a Schematic Design it is then possible to insert a block instance of one of these saved blocks.

Navigating a Hierarchical Design

To navigate up and down in the hierarchy of a design, use the **Push** and **Pop** commands. To **Push** into a block instance, select any part of the block and select the **Push into block** command from the context menu. To **Pop** out of a block instance, back up a level, select the **Pop out of block** option from the context menu. You do not need to select anything it is sufficient that the active page is part of a block instance.

Push/Pop to and from blocks

Once the block has been added to the design, you can move down into the block by using the ‘**Push**’ command. This is available on the context menu once the block is selected, or by using the <PgDn> key on the keyboard.

At the lower level, you ‘**Pop**’ back up into the hierarchical block using the option from the context menu or by using the <PgUp> key on the keyboard.

If you have the **Workbook** mode switched on, the blocks can be navigated using the tabs at the bottom of the screen. You can also use the **Design Browser** Window.

Once you’ve pushed into the lower level you can now add your circuit and Block Ports.

Using the Design Browser and Hierarchical Blocks

The **Design Browser** in the Schematic editor supports and shows **Hierarchical blocks**. It also shows the lock status of the block indicated with a small padlock symbol. This is discussed later in this section under *Multiple Instancing*.

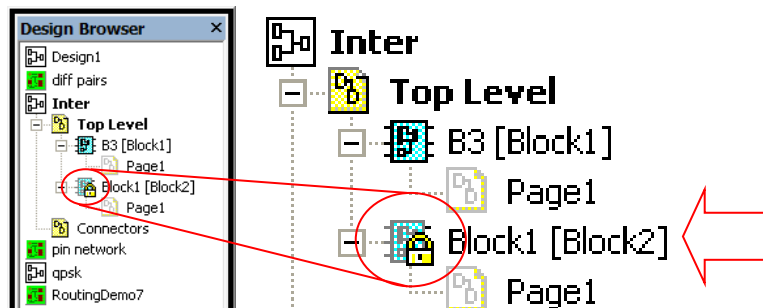

Connecting Through Hierarchy

Using Connections

Instantiating hierarchical blocks gives you the internal connectivity of the block, but you will want to connect these nets through the hierarchy. There are two ways to do this.

If the net in a block is defined as not **local** (global), then it may be used anywhere in the entire design. So the same global net name can be used inside and outside a block instance, and the attached items will be connected together. This is fine, but you will want to define connectivity inside a block instance that cannot be connected to outside the block instance. This is achieved by using a **local** name. Net names are defined in the Technology file.

To connect a local net to items outside the block instance, you will need to use a **Block Port** inside the block. This will match with a pin on the block instance symbol. The mapping between the two is defined in the **Block Properties**.

When a connection is moved over a block, the 'F' Finish marker is displayed to indicate that you can automatically connect to the block using a block port when a block port would be legal.

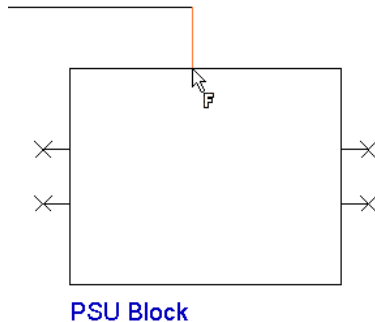

If the block has no defined ports on the lower level then a new block pin is added without prompting. If the lower level has spare block ports defined, you will be prompted with the **Select Block Port** dialog. Use this to select or type the name of the block pin. When **OK** is clicked, the connection will be attached to the block with a block pin.

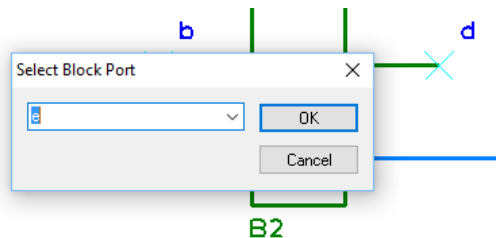

Connecting a Bus to Hierarchy using 'Bus Pins'

Like connections connecting to a block, you can also connect a **Bus** to a Block Pin. When editing a Bus, move it over the Block Pin in the same way you would a connection and the 'F' Finish marker will be displayed. Any Net Names within the Bus will be carried into the hierarchical block via this Bus Port. A corresponding Block Port added on the lower level will also contain these Net Names and can be connected to using a Bus.

Setting up your design for hierarchy

When starting a Schematic design there are settings that you should check in order to use hierarchy. Settings appropriate to hierarchy are defined in the **Design Settings** option, **General** page and **Naming** page.

Allowing Multiple Instanced Hierarchy

Multiple Instanced Hierarchy is the ability to take one hierarchical Block use it multiple times on the design but to have all instances referenced back to one 'master' block. For example, an RGB channel of three identical blocks or a sound mixing desk of many multiple channels.

If you want to use multiple instancing of blocks you must enable the **Allow Multiple Instanced** within the **Design Settings** option under **General** and **Blocks**. If using this for the first time or if unsure, leave it unchecked.

The image shows a screenshot of the 'Design Settings' dialog box, specifically the 'General' page and the 'Blocks' section. The 'Blocks' section is highlighted with a red box. It contains the following options:

- Allow Multiply Instanced
- Schematics Top Level
 - Name:

Other sections visible in the dialog include:

- All Text**: Adjust To Readable Orientation, Barring Character: (when doubled)
- Attributes**: Substitution Char: (when doubled)
- System Font**: Proportional Width Digits
- Matching Styles**: By Name Only, By Name And Value, By Value Only
- CAM/Plot**: Transform about design extents

Blocks which share the same definition and edits on one instance can be applied to the other instances. Without this, each instance is completely independent. This needs to be set before any blocks are added.

The **Schematics Top Level Name** is used in hierarchical schematic designs. It is the name of the top level owner scope and is applied to net names local to the top level (i.e. not in a block instance), using the **naming rules**.

Multiple Instanced Properties

Once this has been selected, the block can be multiple instanced, without this selected, the **Properties** of a block will show the **Can Be Multiple Instanced** greyed out and you will not be able to instance it: If **Locked Instance** is checked, it prevents the contents of this instance from being edited. This is used in conjunction with the **Can be Multiple Instanced** property, to control which instance can be edited.

Description is the description defined on the block. It can be edited on an unlocked block instance. The check box alongside the name shows if the description is currently displayed on the block instance symbol.

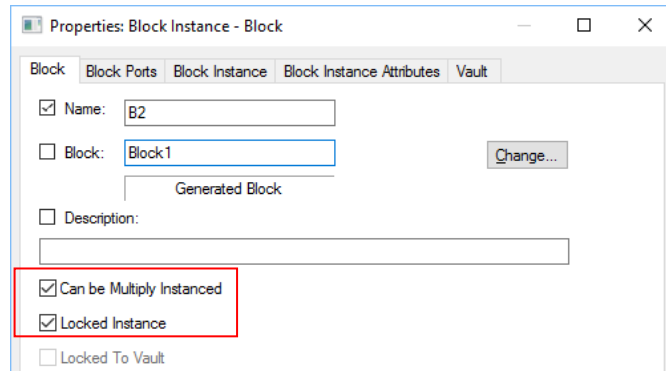

Once a block has been instanced, it is possible to edit them independently so that they diverge from the original definition. More likely, you would want to keep the definitions in step, either with the original block design, or with each other. This can be achieved, by using **Reload Block** and updating from the original block design, or by applying changes from one instance, to all the others.

A block instance also has a Locked instance property that prevents the contents of the instance from being edited or changed in any way. This ensures that it remains a copy of the original definition. A block instance also has a **Can Be Multiple Instanced** property. By enabling this, multiple instances of the block are locked together. Only one of these instances can be unlocked and edited. They can be brought back into line using **Update Multiple Instanced Block**

The function **Unlock Multiply-Instanced Block** appears on the context menu when selecting a block instance, or with nothing selected when editing on a page in a locked block instance. This option allows you to **unlock** the block for editing. Within the Design Browser you can see the lock status of blocks (see below).

With the **Multiple Instance** enabled and the block allowed to be multiple instanced, once copied there are other additional options on the context menu that are displayed.

Use **Update Multiply-Instanced Block** to apply changes made to the design to all other instances of the block.

Revert block option. If you have unlocked and made changes to a block that is a multiple instance you can revert it back to look like the locked copies using this option.

If you unlock a block instance and switch off **Can Be Multiple Instanced** from **Properties**, you will not be able to apply the instancing back to the block.

Net Names on Blocks

The **Design Settings** should be checked so that the program handles the **Blocks** and **Net Names** correctly. Under the **Naming** tab you should set the way in which **Local Net Names** are used. Set **Default to Local Names** and **Name Unique Across Design** to on (checked). This will ensure that net names used within each hierarchical block will be local (and not Global) and that net names across the design will be unique.

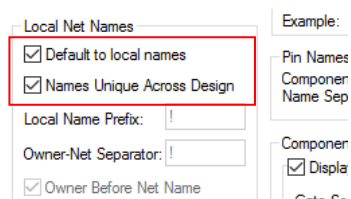

In summary, the **Design Settings** should be like this:

For Hierarchy but not multiple-Instanced:

Allow Multiple Instance	Off
Default to Local Names	On
Name Unique Across Design	On

For Hierarchy but using multiple-Instanced:

Allow Multiple Instance	On
Default to Local Names	On
Name Unique Across Design	Off

Folders and Schematic blocks

All previously saved blocks are located under the **Schematic Blocks** search path defined on the **Setup** menu and **Folders** option. Change this if you wish to add a user location or network drive.

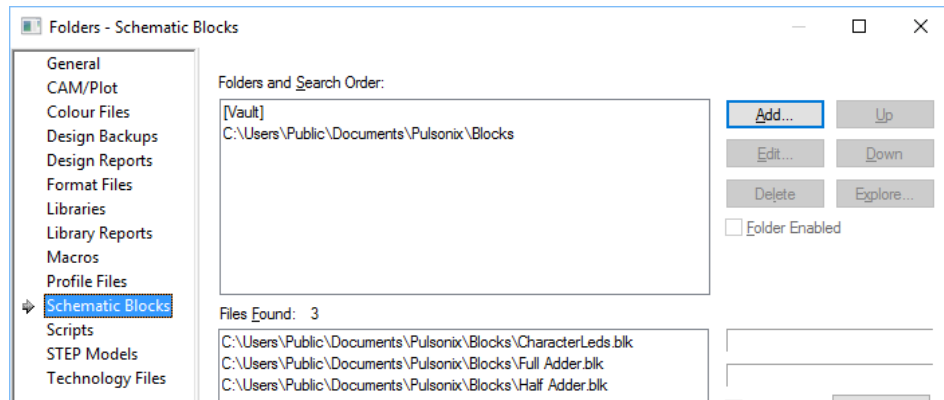

Creating a new block to add to your design

Starting with Top Down design means you will start with a new block and after pushing down into it, will add the circuitry.

The process for creating a new block from the top down is as follows (and this assumes a new block rather than an existing block will be used):

► To add hierarchical blocks using Generate New Block

1. It is assumed that you have adjusted the **Design Settings** accordingly.
2. From the **Insert** menu, use **Insert Block Instance** to add a block to the design.
3. Select **Generate New Block**.

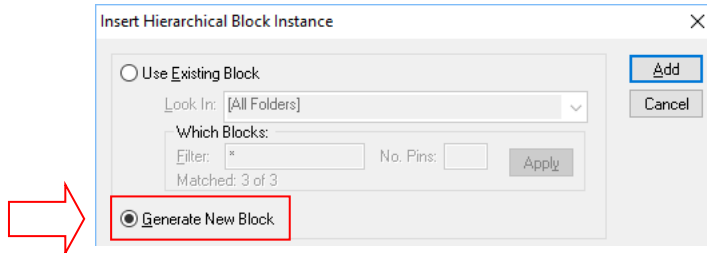

- If the number of ports (input and output pins) is known then these can be set. If not set it to zero (0) and adjust it later on.

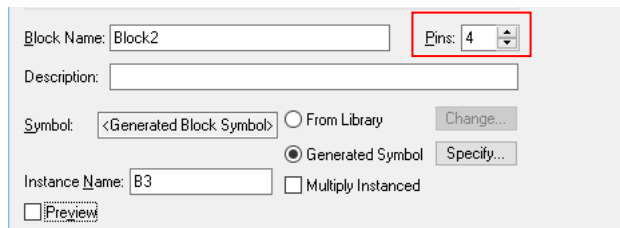

- The bottom section of the dialog is the **Preview** area. This allows you to preview the block before it is added to the design.

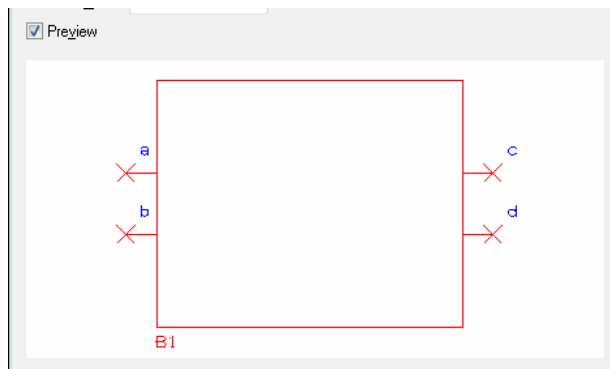

- Press **OK** to add the block to the design.
- Double-click on the block outline to **Push** down into it, or right click and select **Push Into Block** from the menu. On a selected block, you can also use the shortcut key **<Page Down>**
- Once pushed into the lower level block, create the circuit or copy and paste it from another design.
- At the lower level you add **Block Ports** to the design (using **Insert Block Port**) to create interface links back to the upper level. There will always be a direct 1:1 relationship between the lower **Block Ports** and upper level **Pins** of a hierarchical block.
- From the **Insert** menu, select **Insert Block Port**
- Block Ports are added from the **Doc Symbol Library** and are defined as Block Ports during their creation. Use the **Insert Block Port** option to add Block Ports to the design.

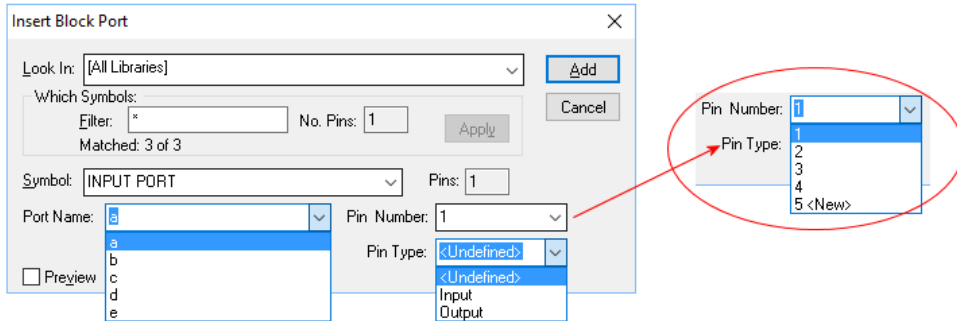

12. The **Insert Block Port** dialog allows you to specify the **Libraries** to be searched in and the **Name** of the Symbol.
13. When adding Ports, if the number of pins was typed in during **Generate Block**, then the Port Name and Pin Number will match this number, e.g. if 4 pins were requested then **a, b, c, and d** will be available for **Port Names** and the **Pin Numbers** will show **1 to 4** and **5 <new>** as the next new pin number. **Port Names** are automatically created and incremented. You can type a name into the Port Name box for use. The next Port added will then be incremented using this name plus one, e.g. the name Port1 is incremented to Port2 etc.
14. You can also specify the **Pin Type** for the Block Port. By default this list is artificially restricted to **Input, Output** and **<Undefined>**. If you wish to use more Pin Types then they must be enabled through the **Technology** dialog under **Pin Types**. Checking any of the pin types in the **Allow on Block Port** column will enable them to be listed.
15. Insert the required number of block ports.
16. Connect your circuit to the Block Ports. Any next names used will appear on the upper level block. Block Ports can be left unconnected if you wish to come back to them at a later time.
17. Pop back up to the upper level using the **Pop** command from the context menu or you can also use the shortcut key **<Page Up>**
18. Now you need to add **Block Pin** to the block.
19. For this example, we'll add block pins to the block automatically.
20. With the block still selected, right click and select **Regenerate Block Symbol**
21. It will now automatically add the corresponding number of Block Pins to lower level Block Ports (regardless of whether they are connected or not).

The block now has a circuit at its lower level, each of the ports at the lower level match the number of ports at the upper level. This is the basic hierarchical design.

Saving Blocks

An auto-generated block can be subsequently saved for use later in another sheet or design. To do this, right click on the block and select **Save To Block File**.

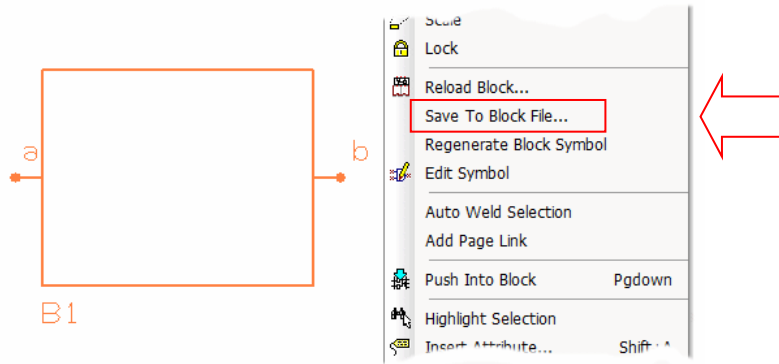

From the **Save As** dialog, type a name and press **Save**. This block will be saved in your pre-selected **Folders**.

When you need to use this new block, from the **Insert Block Instance** dialog, select **Use Existing Block** and choose the **Block Name**: Your new block will appear by name in the drop down list. With the **Preview** box checked, you can also preview it to check it is the required one.

Blocks, Pin Types and ERC

Pin types and Blocks

If you wish to use more **Pin Types** within your block they must be defined and enabled through the **Technology** dialog under **Pin Types**. Checking any of the pin types in the **Allow on Block Port** column will enable them to be listed.

	Name	Type	Allow on Block Port
Y	Output		<input checked="" type="checkbox"/>
Y	Input		<input checked="" type="checkbox"/>
	Bi-Directional		<input type="checkbox"/>
	Open Collector		<input type="checkbox"/>
	Or-Tieable		<input type="checkbox"/>
	Tri-State		<input type="checkbox"/>
	Terminator		<input type="checkbox"/>
Y	Power	Power	<input type="checkbox"/>
Y	Ground	Ground	<input type="checkbox"/>
	Open Emitter		<input type="checkbox"/>
Y	No Connect	No Connect	<input type="checkbox"/>
	Passive		<input type="checkbox"/>
	Pcb Connect	Pcb Connect	<input type="checkbox"/>
	Mounting Hole	Mounting Hole	<input type="checkbox"/>
	Ancillary Pad	Ancillary Pad	<input type="checkbox"/>

The **Block Ports** dialog on **Block Properties** allows you to change the **Name** of the pin, the pin **Number** sequence on the block and the **Pin Type** (used in the **Electrical Rules Checking** option).

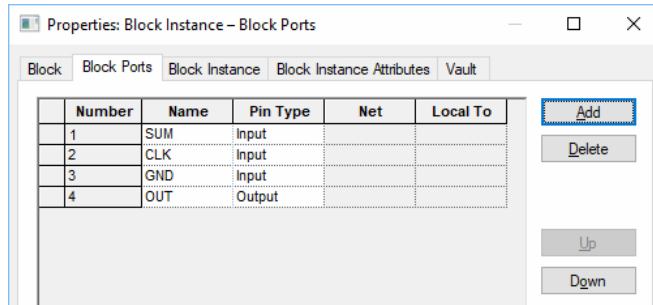

The **Up** and **Down** buttons enable the order of the ports to be changed so that they physically change on the block symbol. These buttons are only enabled if the pin is not connected to a net.

Electrical Rules Checking

All Block Port and Block Pins with Pin types defined are checked using the **Electrical Rules Checking** option and **Pin Type Rules**.

Using an existing Hierarchical Block in the Design

The process for 'Bottom Up' design is much the same as Top down but you use existing blocks that have been saved to the library to build the circuit. Common blocks can be used and reused to create circuits making the design process much easier.

► To add hierarchical blocks using an Existing Block

- From the **Insert** menu, use **Insert Block Instance** to add a block to the design.
- Select the **Use Existing Block** radio button.

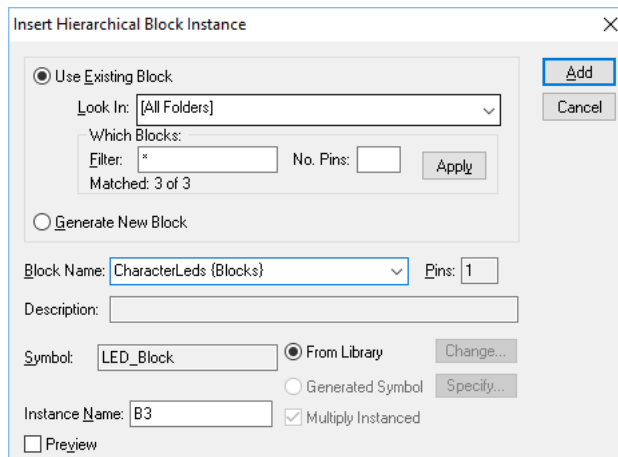

- You can select which folder to looking or select **<All Folders>** (from the folders defined and enabled in the **Folder** dialog).
- Choose the **Block Name:** from the drop down listed presented.

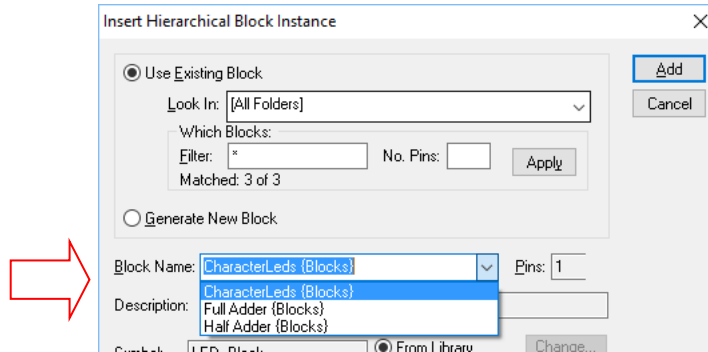

- With the **Preview** box checked, a preview of your block will be displayed for verification.

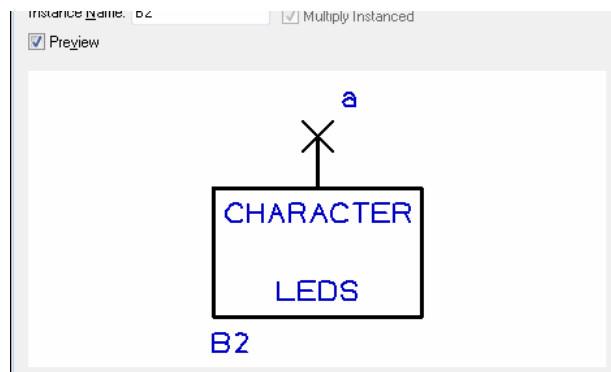

- Click the **Add** button to add the block to your design.
- The block in your design can now be navigated using the **Push** and **Pop** commands.
- The inserted block can also be modified (the Block shape, number of Block Pins and lower level Block Ports and the actual circuitry). This can then be updated and resaved.

Creating a Hierarchical Block from an existing Schematic Design

Below is a brief description of when you have an existing Schematic design and want to create a block from it.

► To create a block file from an existing Schematic

- From within the open design, in free space, right click and select **Save To Block File**

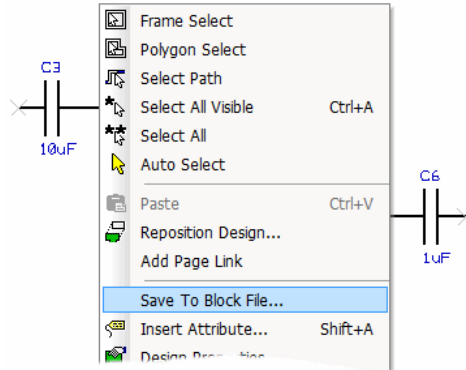

2. From the **Save As** dialog, choose a block name and press **Save**.
3. This saved Block will now be available when you select **Use Existing Block** from within the **Insert block Instance** option.

Cutting an existing Schematic Circuit to a block

If you need more space in the design or wish to save a section of the circuit to reuse at another time or in multiple instances, you can 'cut' a section of a circuit out to a block.

► To create a block from an existing section of circuit

1. From within the open design, from the Edit menu, select the **Cut To Block** option.
2. With the Cut To Block modal cursor displayed, either draw a frame around the required circuit to make the selection or right click to display the context menu.

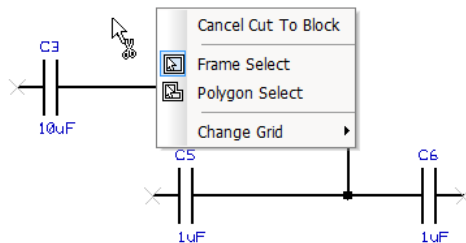

3. From the context menu you can choose to make the selection using a **Frame Select** or **Polygon Select** depending on which mode is appropriate to your required selection. You can also **Change Grid** to make the selection more accurate.
4. This selection can also be pre-defined and changed using the **Frame Select** switch setting under the **Options** option and **Interaction** tab. You have the option for **Frame Select** to **Select If Completely Framed** or open selection if left unchecked.
5. Draw your selection around the required circuit.

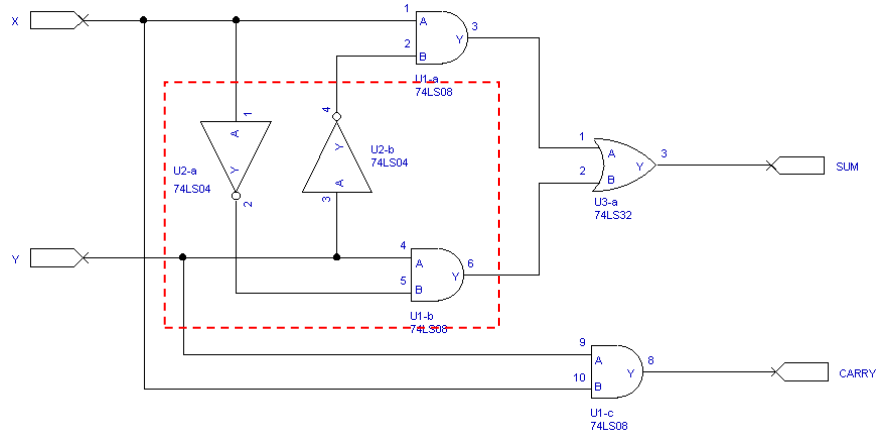

6. In the above example you will see that a section of the design will be cut out and pasted to a lower level block.
7. The block will be created and the appropriate number of Block Pins added to it. Connections around the cut block can be edited and repositioned.

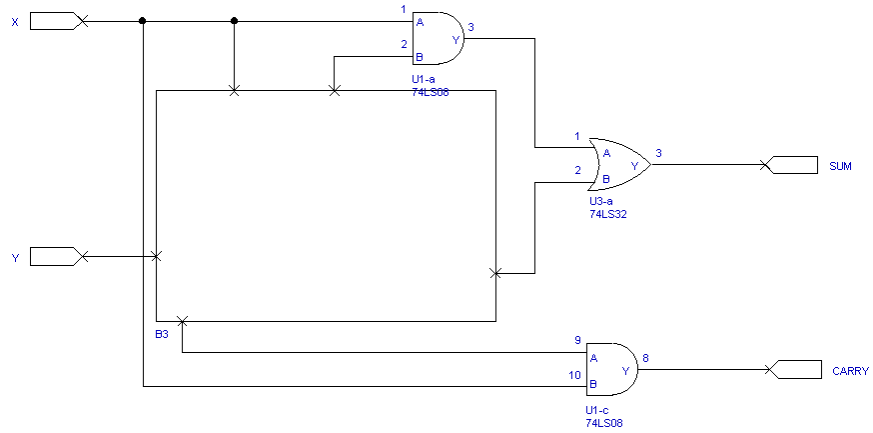

8. The resultant lower level now looks like this when the block is pushed into:

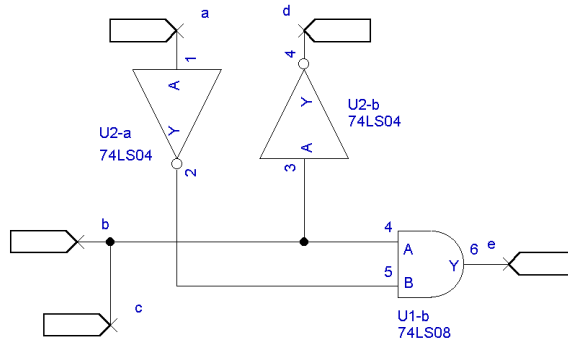

9. There is no repositioning of lower level Block Ports, they are added in exact relative positions from when cut. However, they are a direct 1:1 relationship with the block pins added to the block above, this also includes Net Names.
10. You can see that where connections existed, these have been terminated to the upper level using block ports. The block ports have been automatically named.
- 11.
12. Block Ports can be suitably repositioned and the Schematic circuit edited.
13. The modified block can then be saved here using **Save To Block File**. At this point, the block hasn't been saved, just simply created.

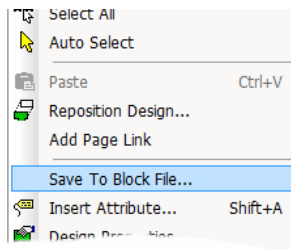

14. Where the design contains multiple sheets, these will also be saved to the block file.
15. This block is now available to use again using **Use Existing Block** from the **Insert Block Instance** dialog.

Editing a block shape

Once a block is used in the design, its shape can be edited. There are some points to note if doing this:

If the port has no block ports and you use the **Regenerate Block Symbol** option from the context menu after adding block ports to the lower level, the shape will be replaced with another automatically generated block symbol.

The modified shape is saved with the block in the Block Library.

After selecting the block, there are various options available for use from the context menu.

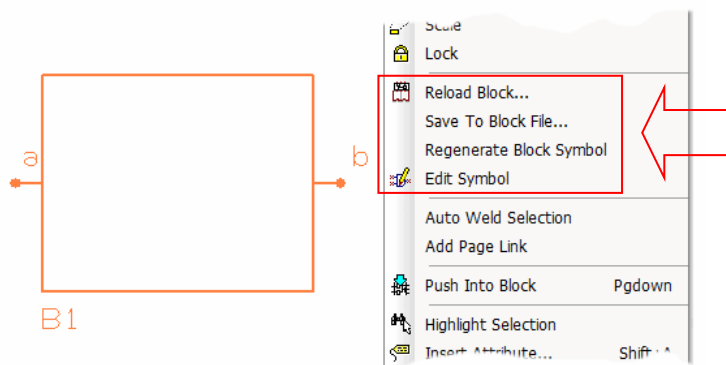

Reload Block will reload the block with the one saved in a block file. If a block file has not been saved for this block then it will not allow you to reload.

If the Block was **Generated** when it was added (i.e. it was not read from an existing Block file), then the block name which was specified at that time, may not exist and the reload will fail. A warning message is given when this is the case.

Save To Block File will allow the block (and its lower level contents) to be saved to a block file, to be used at a later date.

Regenerate Block Symbol will automatically generate a new symbol based on the current number of pins or block ports. If the **Edit Symbol** option has been used and the shape not saved, then this will be lost and overwritten with an automatically generated one.

Edit Symbol allows you to edit the current symbol. If you use this you can also save this symbol to the Doc Symbol library using **Save To Library** to be used and modified later on. If you save the Symbol (using **Save**) from this mode, the block will automatically load this Symbol by name from the library.

Naming/Renaming blocks

Blocks can be named, and once named, can be renamed. This helps you identify them by their functionality perhaps, i.e. Memory, PUSE etc. Initially the block can be named by typing its name when using the **Insert Block Instance** dialog.

Once in the design, it can be renamed by selecting it and using the **Properties** dialog and **Block** tab. **Name** is the block instance name, i.e. B1, B2 etc. (the same block can be instanced multiple times), and **Block** is the block file name (if multiple instanced, this will be the same block name in all instances, the Name will change though). You can also add a **Description** if you wish.

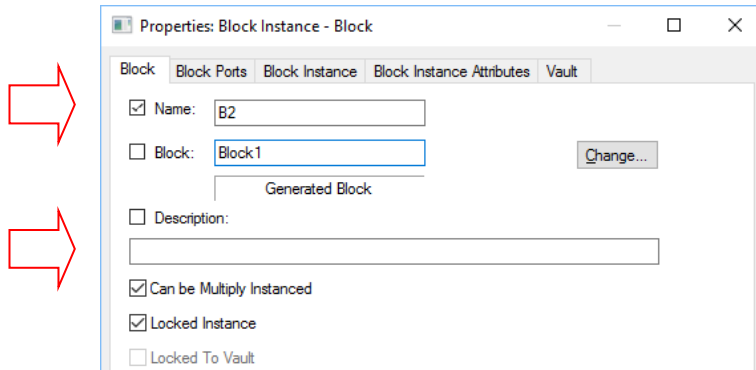

Details from this page can be exported to a report using the **Report Maker** option.

Changing blocks in the design

On the **Properties** of a block instance, the **Block** page has a **Change** button.

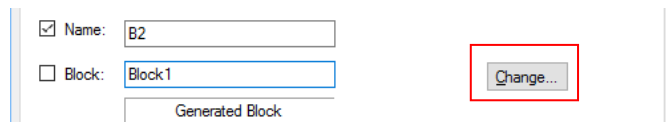

Use this button to change the block using a different block file from the block library. You have the choice whether to replace the symbol or not. The **Change Symbol** button means that the block can be changed with or without changing the Symbol that is saved with that block.

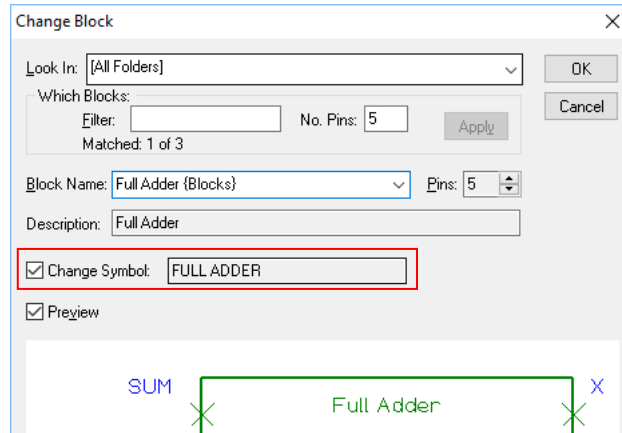

Once **OK** has been pressed, the **Reload Block** confirmation dialog is displayed.

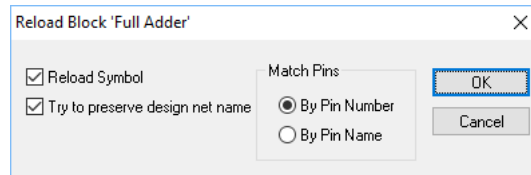

Check the **Reload Symbol** box if you want the top level symbol to be reloaded at the same time.

Check the **Try to preserve design net name** box if you want net names to be as similar as possible to the nets in the existing block. This obviously depends on how much the connectivity has changed within the block.

Working with Multi-Instanced Blocks

A block instance has a **Locked Instance** property which prevents the contents of the instance from being edited or changed in any way. This ensures that it remains a copy of the original definition. A block instance also has a **Can be Multiply Instanced** property. By enabling this, multiple instances of the block are **locked** together. Only one of these instances can be unlocked (**Unlock Multi-Instanced Block**) and edited.

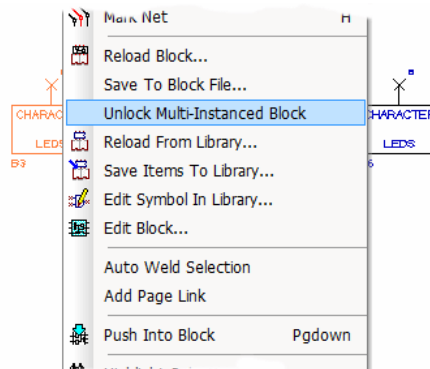

They can be brought back into line using **Update Multi-Instanced Block**. If you unlock one instance of a block and make edits to it you can throw away these edits to make it the same as the other locked blocks using the **Revert Multi-Instanced Block** option from the context menu.

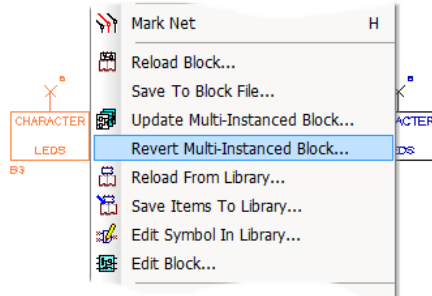

Use the **Update Multi-Instanced Block** command from the context menu to cause all multiply instanced copies of the block to become the same as the unlocked instance (only one unlocked instance is allowed).

Adding More Pages to the Design

Once the design has been started as a single page, you may need to add new pages as the design grows, or modularise the design into logical blocks of circuit functionality.

To add new pages to the design, you should use the **Insert Page** option that is available on the **Insert** menu. From this dialog you can name the page that will be added to the design:

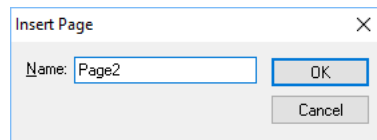

Or you can use the right click option within the **Design Browser** window.

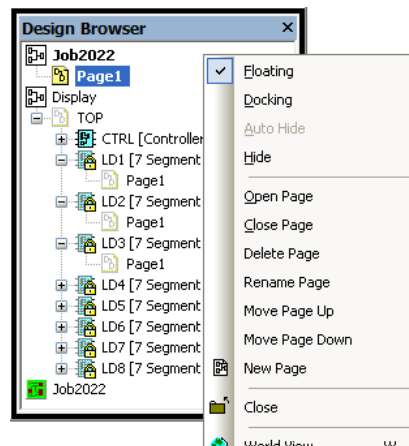

Once the new page has been added, while it is still selected, you can rename it.

You may also subsequently use the context menu to **Rename** or **Delete** the page.

Any page can be opened for editing, or closed using double-click on its name in the **Design Browser**. The new page will not be saved into the design until a **Save** or **Save As** has been completed.

The Design Browser is recommended for use if using multiple pages as it will allow you to navigate through the pages by simply double-clicking on the one required.

Combining Schematic Pages from other Designs

There may be a requirement to work with other engineers who have Pulsonix or another Schematic capture system, and to combine all the Schematic sheets into one master design to create a single PCB design.

There are two different methods depending on where the Schematics is taken from.

Adding a Pulsonix Schematic design

If adding an existing Pulsonix design to an already populated Schematic page in another design, you should use the **Copy** and **Paste** options from one to another. To ensure that the complete design is selected, you should use the **Select All** option from the context menu (or use the keyboard shortcut **Ctrl-A**). For specific areas of circuitry to be copied, use the **Frame Select** or **Polygon Select** options also available on the context menu.

During the **Paste**, any duplicate **Net Names** will be highlighted by the Resolve Net Names dialog for you to resolve. This will allow you to combine net names as required, for power and ground nets, for example. Any duplicate Component Names will automatically be resolved without warning but will be incremented, if the name already exists, to the next available in the sequence. Components can be renamed at a later stage manually or by using the Component **Rename** option.

If you wish to add the design page to create a new page in the existing Schematic, you should add a new page first and then Copy and Paste the contents into it. Again, any duplicate net names will need to be resolved and the Component names will automatically be resolved as before. All Schematic pages under a design are checked for duplicate net and Component names.

Adding another system's Schematic design

If taking the Schematic Design from another system, you must first import it. In brief (this procedure is described in more detailed later on in the manual), use the **Open** option from the **File** menu. Locate and select the Schematic design and click **OK**. The Pulsonix Import filter will automatically detect the format and import it into Pulsonix. If you are familiar with the **Data Transfer Wizard**, you can also use this mechanism for a more guided import approach. Once in Pulsonix, the Schematic will behave as if it originated in Pulsonix itself.

The procedure then for combining this imported Schematic and the existing Schematic design is as already discussed above in *Adding a Pulsonix Schematic Design*.

Building up the Design using Copy and Paste

Now that the design has components, Busses and Connections added it, a fast way of building it up is to use **Copy** and **Paste** or the **Duplicate** option, to copy sections of circuit to use elsewhere on the page or other sheets. Cut and Paste can also be used successfully to move sub-circuits to other pages. Copy and Paste are detailed in an earlier Chapter on *General Utilities*, but we will deal here with naming issues when pasting to an existing Schematic design.

Resolving Net Names when using Paste

During a **Paste** or **Duplicate** operation, **Component** and **Connector Names** are automatically incremented to use unique names but net names need user interaction to resolve.

The **Resolve Net Names** dialog shown below is displayed. This allows you to choose the nets that are to be connected to those already present, and that are to be renamed so that they do not join existing nets.

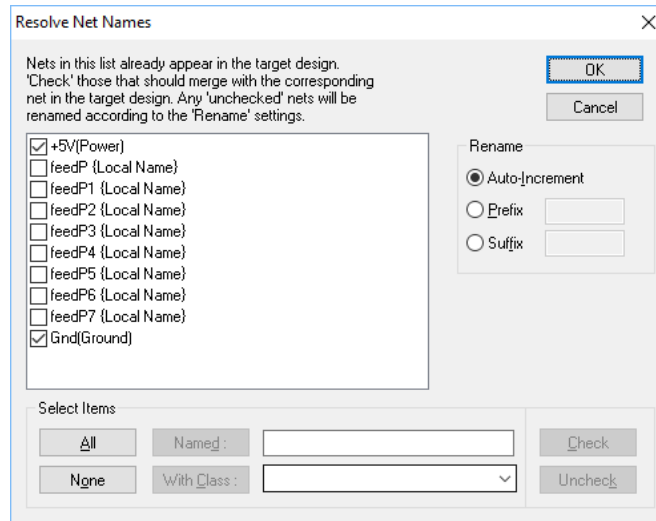

Nets that are unchecked in the list have a Rename applied to them based on the Rename criteria chosen.

► The resolving net names process

1. The first step is to identify those nets that need to be connected to existing nets. This is done by 'checking' the names of those nets in the list.
2. To do this, you can either click on each of the checkboxes directly, or use the Select Items filters to help you quickly select and then check/ uncheck whole groups of nets in one go.
3. The next step is to define the Rename criteria to be applied to the net names left unchecked in the list.
4. When you have chosen how you wish the nets to be resolved, press OK and the Paste or Duplicate operation will continue. The current settings for the Rename criteria will be preserved and used next time the dialog is displayed.

Using the resolve net names dialog

The **Don't Ask Me Again** check box is used to switch off this dialog after making a selection. The warning can be switched back later on using **Options** dialog and **Warnings**.

Net Names shows the net names being duplicated or Pasted that are already in the design. Nets can be checked/unchecked from this list directly by picking or by using one of the **Select Item** methods. Checking them to merge with existing nets, or by leaving them unchecked, the rename criteria is applied.

Auto Number applies an automatically generated default net name to the unchecked net (or nets). The number used is the next available in the default net name sequence, e.g. A0 could become N0027, where N0027 is the next unused default net name available in the sequence.

Auto Increment is used to increment the unchecked net name to the next available unused net name in the sequence, e.g. A0, A1 and A2 becomes A3, A4 and A5 respectively.

Prefix - this radio button is used to direct the rename to use a predefined prefix at the start of the existing net name. E.g. C10 becomes ZC10 if the Prefix is set to Z. This Prefix is applied to all unchecked net names.

Suffix - this radio button is used to direct the rename to use a predefined suffix at the end of the existing net name. E.g. A10 becomes A10_B if the Suffix is set to _B. For all the rename types, it will continue to increment the resulting name until it finds one that does not already exist in the design. This suffix is applied to all unchecked net names.

Select Items is used to select the net names in the nets column based on selection criteria. Once selected, use the Check or Uncheck buttons to check or uncheck the selected nets.

All selects all names.

None deselects all names.

Named allows you to type in a name or string with wildcards to make the selection, i.e. A* will select every name starting with A, e.g. A0, A1 etc. More refined selections can be made by increasing the characters to filter, e.g. A2*

With Class allows the Net Class associated with the nets in the list to be used as the selection criteria. This enables you to select nets using Net Classes of Power for example, which in-turn can be checked for connecting to an existing named nets.

The **Check/Uncheck** buttons are used to check or uncheck the selected nets in the nets names list.

Using Testpoints

Testpoints are used for a number of reasons on a Schematic design:

- To annotate a theoretical testpoint that an engineer might use on the PCB to ‘probe’ a given electrical statistic or measurement. This may be on a particular Component pin, or added separately using a documentation symbol to indicate that a particular net is to be tested. These are passed through to the PCB design during Translate To PCB. They do not appear in the design’s net or part lists.
- To define a physical testpoint part on the PCB, that is added as a Component on the Schematic by the engineer and is again passed through to the PCB design during Translate To PCB. These parts do appear in the design’s net and part lists.

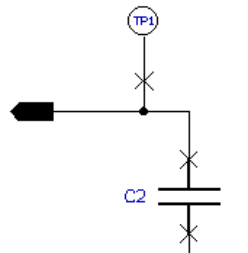

Pulsonix provides an **Insert Testpoint** option, on the **Insert** menu, for adding each of these types of testpoint. Alternatively you can select a Component pin and use the **Change Testpoint** option from the context menu to mark the pin as a testpoint.

Testpoints are Doc Symbols with the property of **Testpoint**, defined during their creation. See the Doc Symbols section previously.

► To Insert a Testpoint

1. Click the **Insert** menu and click **Testpoint**.
2. Right click to use the context menu to choose whether to **Insert Testpoint Part** or **Insert Testpoint Doc Symbol**.

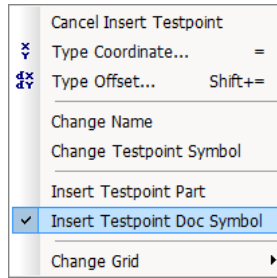

3. Use **Change Testpoint Symbol** from the context menu if a different symbol is required. Note that if a symbol has not been setup yet, you may enter the **Change Symbol** dialog automatically.
4. Right click to use **Change Name** from the context menu to change the default name supplied (shown on the status bar). The default testpoint name stem is taken from the testpoint **Defaults** in the **Design Settings** dialog.
5. Select an item on the net to be tested. A testpoint part or doc symbol will appear at the end of the cursor for you to move into the correct position. It is connected to the picked item.
6. Click to drop the testpoint in place and either add another or press the <Esc> key to exit this mode.

Doc Symbol Testpoints (not Parts) translate to the PCB design as floating test lands (PCB Doc symbols) ready for the PCB designer to place in appropriate positions on the net to be easily probed. The point of adding these to the schematic is to indicate to the PCB designer the nets need to be probed.

Testpoints added directly to a Schematic symbol pin are translated into the PCB design. These are added automatically to the corresponding pad of the Component. The pad is made into a testpoint (as you would if you selected the pad and used **Properties**, **Testpoint** to add it).

Adding Shapes

Within the Schematic design, shapes are sometimes required. You can use the **Insert Shape** option from the **Insert** menu to add documentation shapes. These shapes can be **Open** or **Closed**, **Filled** or **Unfilled** and **Hatched** or not. You can also change the Style of the line (when using non-filled shapes) to be **dotted** or **dashed** in appearance.

The default shape used when adding documentation shapes is taken from the **Design Settings and Defaults** dialog. As well as the **Line Style** of the shape, the **Hatch Style** can also be defined provided the Closed, Filled and Hatched check boxes are selected.

Once a shape has been added to the design, you are able to use the **Insert Cutout** option to cut shapes out of the existing shape.

► To add documentation shapes

1. Click on the **Insert** menu, click **Shape**
2. Draw the shape onto the design using a single click to insert corners.
3. At any time you can use the context menu to change options of the shape, e.g. **Style**, **Closed** etc.
4. While inserting the shape or editing it, you can also select **Common To All Pages** from the context menu. This will put the shape onto all pages within the current design, e.g. if it represents a page border.

Use of Attributes in Schematic Capture

This section details specific attributes associated with Schematic Capture. The general process of adding attributes has already been covered in the Chapter under *Setting Up The Design*.

Displaying Attributes

All attribute names in the design are available in the Colours dialog. These can be set to be Displayed, Selectable and to have their individual colours changed. All system attributes are shown in brackets e.g. <Component Name>, <Date> and user defined attributes shown without brackets e.g. Cost.

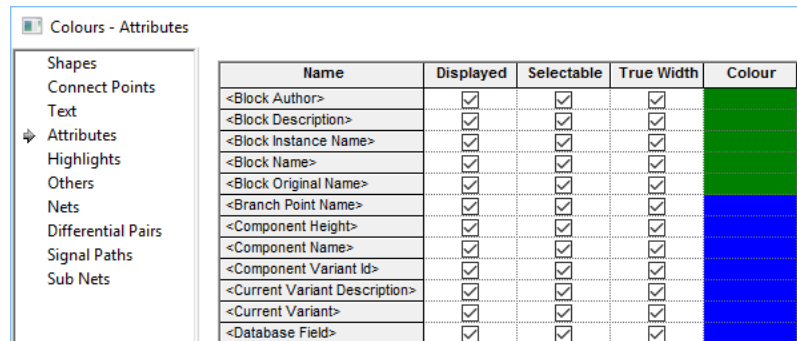

System Attributes

There are a number of system attributes that present themselves in the design as part of Components and Nets and other used design items. Attributes such as **Component Name**, **Gate Modifier**, **Part Name**, **Part Description**, **Net Name** etc. are used throughout.

There are some attributes that can be used to add design-level information that changes dynamically as the design is updated. For example, **Date**, **Last Save Date/Time** and **Design Author** are a selection of the available design-level attributes.

User Defined Attributes

New attributes can be added to any design item within Pulsonix. These user defined attributes can be extracted using the **Report Maker** output. In Schematics, attributes would generally be used for showing Costs, Preferred Manufacturer, or simulation parameters such as Model Name etc.

Attributes on components that have their attribute names marked as being 'both' design types (PCB and Schematic) will be copied to the corresponding PCB Component when Translate To PCB is used.

Translating the Schematic to PCB

The final process before starting on the PCB design itself is to translate the Schematic design into the PCB design environment.

With the concurrent checking and procedures that Pulsonix Schematics adheres to, by the time you translate to PCB there should be very few warnings or errors to resolve before the design is acceptable to start design the PCB with.

Before starting this process, you should check that there are no components in the Component Bin that should be translated. Any components in the Bin are not translated unless part of a multi-gated device already used in the Schematic.

When you are in a position that you wish to go-ahead with this transition, you should use the **Translate To PCB** option from the **Tools** menu.

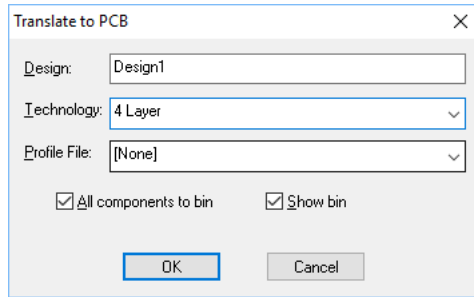

This dialog provides you with the option to name the new PCB Design although a default name matching the Schematic design name is provided. If you decide to use this, it will make it easier later on when you use the **Synchronise Design** option, or **Cross Probing**, as both options use the same Schematic and PCB Schematic design names as default.

The **Technology** box allows you to choose a **PCB Technology** file to use. The technology defines the layers, power planes, pad styles, track styles, etc.

The **Profile** box allows you to choose a **PCB Profile file** to use. This will give you a jump-start, because you can have your board outline and other general annotation predefined. You can also have critical components pre-placed in the profile, e.g. edge connectors.

Check the **Unplaced components to bin** option if you want to use the **Component Bin**, otherwise components are stacked in the design area or around the board outline if one is available.

You can opt to **Show Bin** if you have selected the option to place unplaced Components into the bin and wish it to open automatically to view its contents.

Libraries

Parts from the Parts library have already been used in the Schematic design, these will have the corresponding PCB Footprint symbol associated with them. When the translate process begins, the Parts used in the Schematic are extracted and used in the PCB design along with its footprint.

If any Part used has more than one entry in any other Parts library within the Libraries search path, the first entry found will be used.

The Path for the libraries is defined in the **Folder** option located on the **Settings** menu.

Doc Symbols

During the **Translate To PCB** process doc Symbols are not translated. These are retained in the Schematic design for documentation purposes only.

Predefined Signals

Normally, you would not display all the Power and Ground pins on gates in your Schematic. Instead these are added as Net names on the appropriate pins within the Parts in the Parts library. These Power pins will be automatically connected when the Schematic is translated to PCB. Predefined net names on pins that are not on a gate in the Schematic will not be added when translate to PCB is performed.

PCB Footprint Selection

You may edit the footprint name on a Component in the Schematic, or leave it blank to use the default on from the Part definition. Translate to PCB will try to use the supplied name, but will use the default name if it cannot find it.

Interpreting messages during Translation

There are three types of messages displayed during **Translate To PCB**:

- Information
- Warnings
- Errors

Information in the report will inform you of what has been completed and whether it is successful or not. It will also provide you with other related information such as the time and date translated, the file name, folder etc. This may be required for any quality procedures or audit trails.

Warnings are non-fatal messages that inform you of automatic changes that the program has done during the translation. All warnings should be read and noted. You may wish to correct warnings before continuing with the PCB design. Any corrected design should be re-translated to use the corrections. The warnings could also be for items, such as Attributes or Net Classes that exist in the Schematic design but not in the PCB Technology File. These are automatically passed through and added to the PCB design. The warning will inform you that they've been added and to check and edit them in the PCB design.

Errors are displayed where the program finds illegal data. For example, a Part used in a Schematic that no longer exists in the library because it has been removed, renamed or not available from the folders path defined. All errors must be checked and corrected to ensure the full integrity of the PCB design against the Schematic.

Once any corrections have been made to the Schematic, the translation process must be undertaken again. On any subsequent translation, ensure that all warnings and errors are verified and if necessary, resolved.

Exporting Netlists

From Pulsonix you can output a netlist from your Schematic design in ASCII format specific to other systems using the **Export Netlist** option located on the **File** menu.

During the output, a netlist is collated and written in a PCB format suitable for import into other system's PCB design editor. This means the netlist contains unique Component names and net names that are fully resolved with all associated names connected e.g. power and ground and busses etc.

The netlist is written in an ASCII format, in the format of the target system that you choose from the drop down list box.

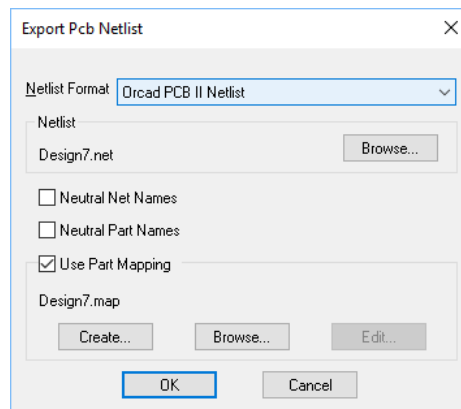

The export list is not exhaustive but does cover all of the commonly used and widely accepted file formats.

The netlist required for export should be chosen from the drop down list available under **Netlist Format**. By default, the netlist will be written to same location as the design, use the **Browse** button to change this location.

Dialog Options

Options on this dialog allow you to create a file with **Neutral Net Names** or **Part Names**. If you are sending the file to an external company, this will help you to preserve your IP.

Using Part Mapping Files

If using the Pulsonix Schematics system and another vendors PCB system, you may find that the Part names used in Pulsonix are different to that in the other system. Instead of editing the Parts in one of the libraries to match, you have the ability in Pulsonix to use a mapping file. This mapping file is generated automatically and contains the Pulsonix Part name and Footprint name, and mapped equivalents that would be used in the other system.

Exporting Spice Netlists

You can also export Schematic designs in Spice netlist format. Within Pulsonix, you can prepare components for Spice output and add circuit stimuli and fixed probes, then generate a Spice netlist.

To set the Spice Netlist Type

Before running a Spice netlist, you must choose the type to export to, each one has its own ‘flavour’ of Spice. Select the **Set Netlist Spice Type** from the **Simulation** menu in Schematics.

First choose the **Spice Netlist Type** from drop down list for the simulation file. The simulator commands in the netlist file will be formatted to suit the chosen simulator.

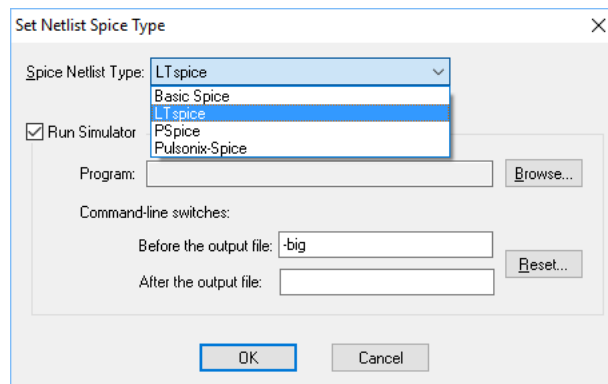

If available, you can choose to use the **Run Simulator** check box to specify whether you can directly run a simulator as well as producing the Spice netlist. This will seamlessly write a Spice netlist, then run the appropriate Spice engine without having to re-create the Schematic and no additional user intervention.

Use the **Browse** button to locate the program to be run on your computer. Where possible we have added filters to this dialog to suggest a possible simulator program name.

Add any command line switches that are needed to run up the simulator, either before or after the output filename. Initially these will be set to default values for each simulator type. If you change them you can use the **Reset** button to revert back to the default values.

Press **OK** to accept the change. If **Run Simulator** is checked you will be able to use the **Simulate Design** option to pass your Spice netlist directly to your simulator.

Outputting a Spice Netlist

To generate a Spice netlist in the format you have chosen, If the **Program** has been previously set up, use the **Run Simulation** option from the **Simulator** menu. If this has not been set up, you have to use the **Create Spice Netlist File>** (from the **Simulator** menu), then choose one of the page options and the location using the **Save As** dialog.

Reverse Engineer

From within a PCB design, it is possible to take your PCB and reverse engineer it back to create a new Schematic design. Other than the PCB option to initiate the Reverse Engineer, all the functionality of this option is within the Schematic editor. In PCB, the **Reverse Engineer** dialog on the **Tools** menu allows you various options and selections to be made when the option is run.

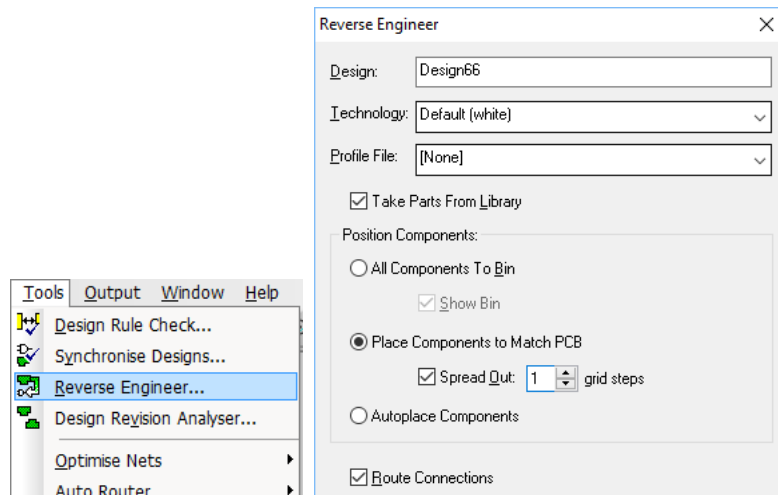

Components can be added to the **Component Bin** in the Schematic design. The bin is divided between unused and used gates; you should place all the used gates onto the Schematic pages to complete the design.

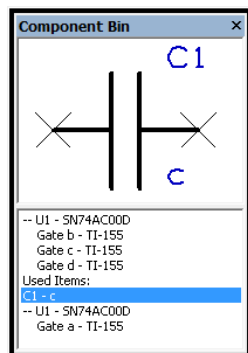

Components in the PCB design that are flagged as PCB Only Parts are not reverse engineered. If you wish to reverse engineer Components, they need to be edited in the Part editor and Schematic

symbols added, then use the **Reload** option to reload those updated Parts to the design. After this you can use the Reverse Engineer successfully.

For components that don't have a Parts library entry (because they came from an external source for example), these components will be reverse engineered but the Schematic Symbols will be automatically created for you. The shapes of these Symbols will be generic boxes and not the real shapes.

Schematic Routing

When the **All Components to bin** check box is **not** selected, components are placed in the design using their relative PCB design positions and using suitable placement spacing (or **Autoplaced** using the other radio box selection).

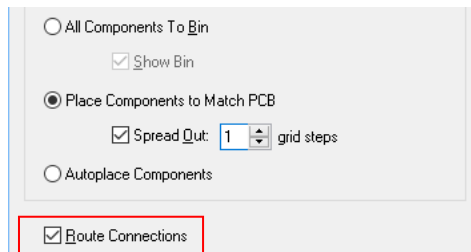

Having the **All Components to bin** check box unchecked enables you to also select the **Route Connections** check box. Once the design has been placed in the Schematic the connections can be automatically routed using the Schematic connection router.

Printing and Plotting the Schematic Design

When you wish to obtain a hard copy of your design, there is a choice of two methods for outputting prints and plots from Pulsonix:

- The Print option from the File menu that will print the current design exactly as it appears on the screen. It will output to the selected Windows printer and will be automatically fitted to the paper size.
- The CAM Plot option from the Output menu to Print or Plot a user defined output to a selected device using defined parameters. This allows you to also choose not to include some design item types. Using this method, Pulsonix plots everything in the design on a per page basis unless excluded from a plot. The control over the size, scale, position and contents can be defined using the tools provided.

Using the Print Option

The print option is a quick and easy method of generating a print of the Schematic using your default Windows printer.

When selected from the **File** menu, the **Windows** printer dialog is displayed.

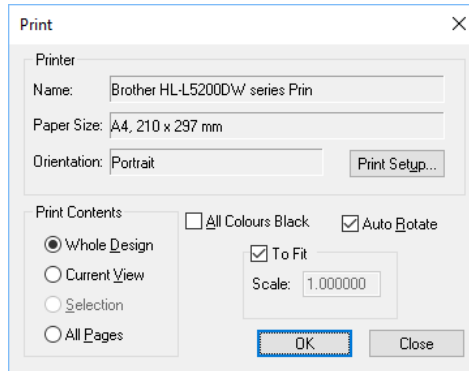

From this dialog you can select the number of copies to be made and select the print range.

This dialog also gives you access to more advanced printer specific options allowing you to change settings such as Colour/Black & White, paper size and orientation of the print. You can also force the print to **All Colours Black** and the **Print Contents**.

If a more specific and consistent print is required, independent of the screen view, the **CAM/Plot** option on the **Output** menu should be used.

The **CAM/Plot** option is a fully configurable single 'shot' output mechanism that allow you the full flexibility to output the plot(s) required.

Using the CAM/Plot option

The **CAM/Plot** output option is available on the **Output** menu.

The CAM/Plot set up parameters are defined in the **Technology**, if they are not available the first time you try and enter this option (or the first time you enter the Technology and CAM/Plot tab) you are presented with a dialog to request auto-generation of the parameters.

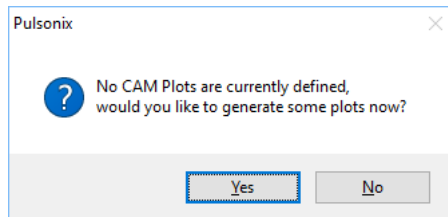

If you click **No** to this, the CAM/Plot mode is entered ready for you to create the parameters interactively. If you click **Yes**, the **Auto Generate CAM/Plots** dialog is displayed:

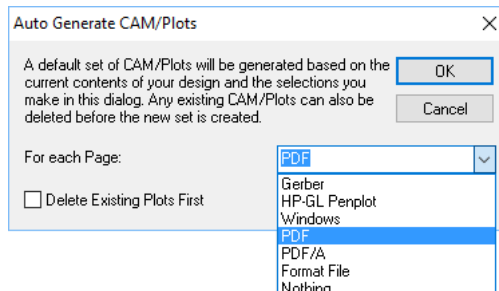

From this, you can select the default plot mode for each page or block of your design.

Once in the CAM/Plot dialog, you can select other print or plot types for any page. You can also opt to have a Windows and Pen Plotter output for each page if required. As well as defining plots or prints, you can also output reports from the format files created.

Overview of the CAM/Plot dialog

The dialog itself is split into three sections with a panel at the base of the dialog used to run the plots. This panel is available during the use of all three dialogs.

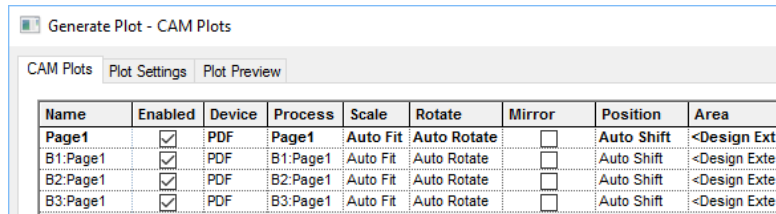

Plot Preview is used to display a preview of the final plot. This should provide you with an idea of what the plot will look like before it is plotted or printed.

CAM Plots is used to set up the characteristics of the plot, the scale, rotation, plot type etc.

Plot Settings is used to set up the plotter or printer. This dialog also contains a location for the destination of the plot output if a file is being output.

Run is used to start any plots that are enabled and to save the current settings. **Cancel** is used to exit this dialog and **Apply** is used to save the current settings but not run the plot. The **Close** button is displayed instead of **Cancel** once the **Apply** button has been pressed, this closes the dialog also.

Plot Preview

The **Plot Preview** dialog allows you to select the page required to preview.

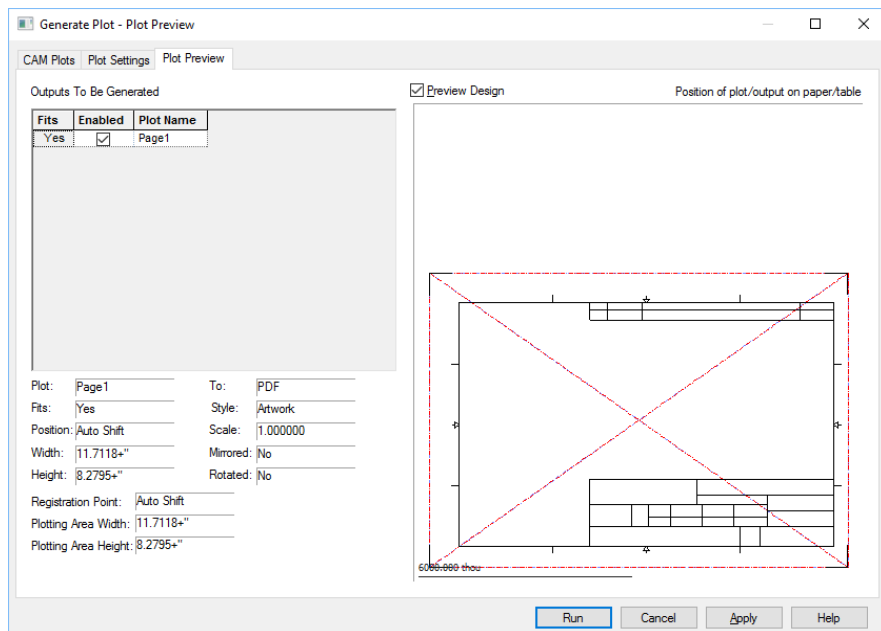

The page is represented using a **Plot Name** defined on the **CAM Plots** dialog; this also helps identify the type of plot being output if a sensible name is used. The **Enable** check boxes will allow you to select which plots will be output when the **Run** button is pressed. This means you can opt to run all plots required in one single button press regardless of the plot type or even if mixing plot types.

The **Fits** column will display an **X** if the plot does not fit the paper. Most times you will be able to see if the plot will fit but if marginal, this acts as positive confirmation that it will or won't fit.

The preview window displays the plot selected in the list. It shows two main boxes (shown with a 'cross' in each to help identify the centre). The first is the plot bed (the paper extents or the bed size), this is the large box shown in Red. The second is the design extents shown in Blue. Also shown are elements of the design to give you an indication of the orientation and the scale relative the paper. The preview window can be switched off by deselecting the **Preview Design** check box.

All other information shown in this dialog is confirmation of the **CAM Plots** dialog settings.

CAM Plots

The CAM Plots dialog is used to set up the plot for output and how the plot will appear relative to the paper being used.

If a standard plot is required, the plot can be almost completely defined used the Auto Generate dialog when you first enter the option. The only setting you may need to adjust is the plotter type for Windows or Pen Plotter or the Exclusion of items not required in the plot.

The grid matrix displays the options selected for each plot. Each of these can be edited interactively or by using the Plot Wizard once a row or item on a row is selected. The Plot Wizard is enabled once the row is selected by clicking on the **Edit** button.

If no plots exist or you require a new plot, you can use the **New** button that will use the **Plot Wizard** to complete this task. This will lead you through the plot type generation process to create a new line in the plots table. If you have a plot selected, **New** copies the properties of this plot into the **Plot Wizard**.

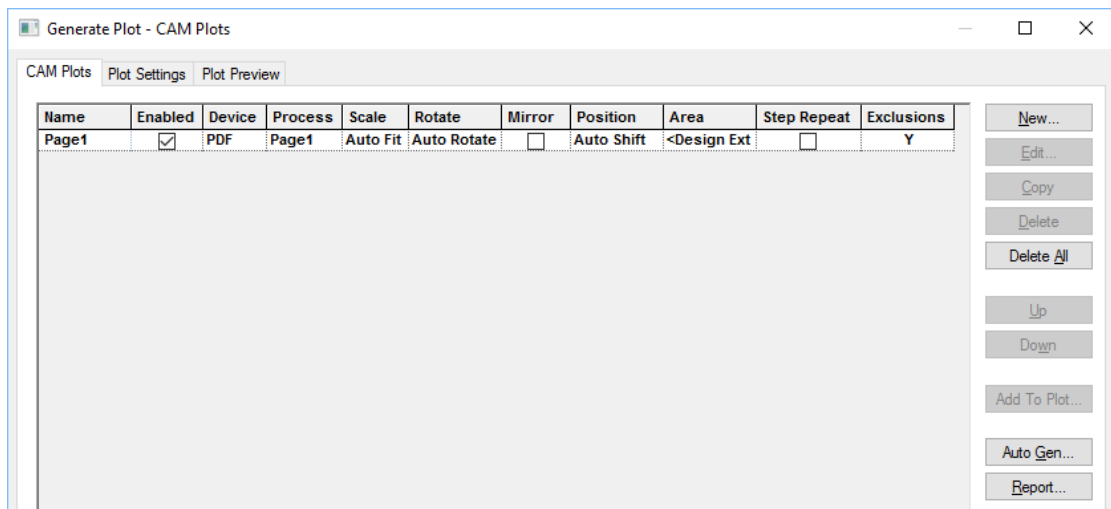

The **Edit** button displays the first page of the **Plot Wizard**. Each of the pages of the plot wizard will allow you to set up facets of the plot to be output. See later on in this section for an overview of the Plot Wizard.

The **Delete** button is used to remove any unwanted plots from the grid.

Add To Plot is used to combine plots and is more relevant to the PCB Design editor. When selected, it displays the Process page of the Plot Wizard from where to choose a process to add to the plot selected. The **Add To Plot** option will add the plot to any other plot selected. If it gets added to the wrong plot by mistake, select it, and use the **Delete** button to remove it.

If when you started this option, you clicked **No** to Auto Generate the plot type, you may now use the **Auto Generate** option to create a set of plots ready for use. This can be an alternative to using the **New** plot option.

The **Reports** button is used to generate a summary report listing the plots and their settings, in case you need to keep this for future reference. This is in addition to any reports generated at the time of actually running the plots.

Step & Repeat is used to create ‘panelled’ designs. See the later section in this *chapter* on *Step & Repeat*.

Using the Plot Wizard

The **Process** page defines the **Name** of the plot and the Schematic Page to be output. The plot name is for reference only to identify the plot and if left blank will be automatically completed using the Page name.

The **Output** selection is used to define the device used for the plot. In Schematics this will be **Windows**, **Gerber**, **Format file**, **HP-GL Pen Plot** or **Nothing**. *Nothing* would be selected if the plot type was undetermined at that time.

The screenshot shows the 'CAM Plot Wizard - New Plot' dialog box, specifically the 'Process' page. On the left, a vertical progress bar indicates the current step: 'Start' (blue), 'Process' (green), 'Output' (grey), 'Size' (grey), 'Design Position' (grey), and 'Finish' (red). The main area is titled 'Choose a name for this plot and choose the type of output'. Below the title, it says: 'Define the name which will be used to identify this plot in dialogs and reports. Also choose the type of output.' The form contains the following fields:

- Name:** Plot1
- Plot Group:** Windows (dropdown menu)
- Plot String:** (empty text box)
- Output To:** Windows (dropdown menu)
- Printer Name:** <Default Printer> (dropdown menu)

The **Style** of the plot can be either **Artwork** or **Outline**. Artwork will give you the true width of all items whereas Outline will only output the item as a centreline unfilled shape.

The screenshot shows the 'CAM Plot Wizard - New Plot' dialog box, specifically the 'Output' page. On the left, the progress bar shows 'Process' (green) and 'Output' (grey) as the current steps. The main area contains the following fields:

- Process:** Page1 (dropdown menu)
- Style:** Artwork (dropdown menu)
- Mirror:**
- Exclude Items...** button
- Has Excluded Items** text

The **Mirror** check box enables you to select whether the plot is mirrored or not.

If output to **Format File** has been selected, you can choose a format file from the drop down list presented.

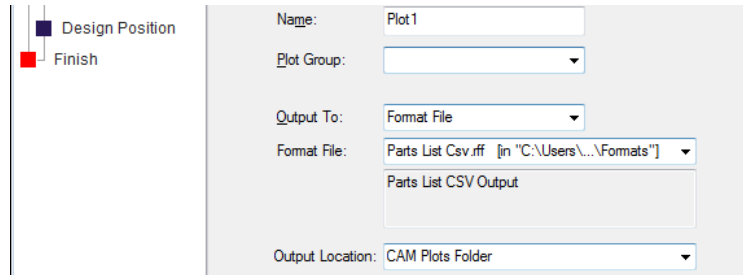

From this page you can also select which items to **Exclude** from the plot. If nothing is selected in this dialog, all items visible in the design are plotted.

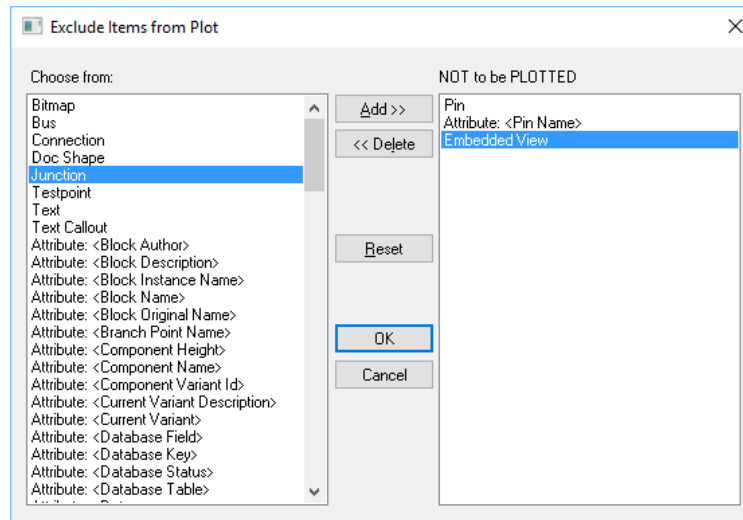

The **Size** page uses selections to define the **Scale** and **Rotation** of the plot. For Scale, the choice on the drop down list is **Auto Fit** and **1.00** (a scale of 1:1). You can also type in your own scale choice. The Rotation drop down list allows you the choice of **Auto Rotate**, **No Rotation** or **Rotate 90 degrees** (forcing the rotation to 90 degree from its original position).

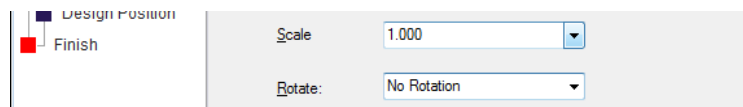

The **Design Position** page defines the position of the plot relative to the plotter type being used.

The **Design Position** provides a number of options from where to move the design on the plot. The design location specified here is aligned with the location on the paper or plotter table specified in the **Device Registration Point**. This is set in the **Settings** tab of the **Output** dialog. This allows accurate and repeatable registration of plots to be achieved if the correct combination of values is chosen.

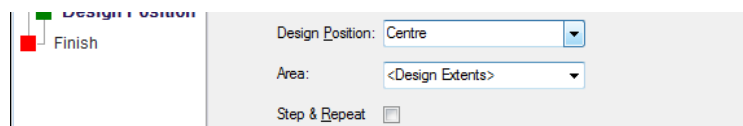

For example, if both Position and **Device Registration** are set to **Origin**, the design origin is aligned with the origin (0,0) on the plotter.

If either the **Position** specified here or the **Device Registration Point** are set to **Auto Shift**, then the plot is positioned as best as possible on the output device.

The **Step & Repeat** button indicates that the plot can be duplicated on the same sheet. This must be used in conjunction with the **Step & Repeat** option on the main CAM Plot dialog.

The **Finish** page provides you with a summary of the options selected in the Plot Wizard. Once the **Finish** button is pressed, the plot type is generated and added to the plot grid.

Plot Settings

The **Plot Settings** page is used to set up the printer, plotter or output device, such as **Windows** or **PDF** and the location of the files output.

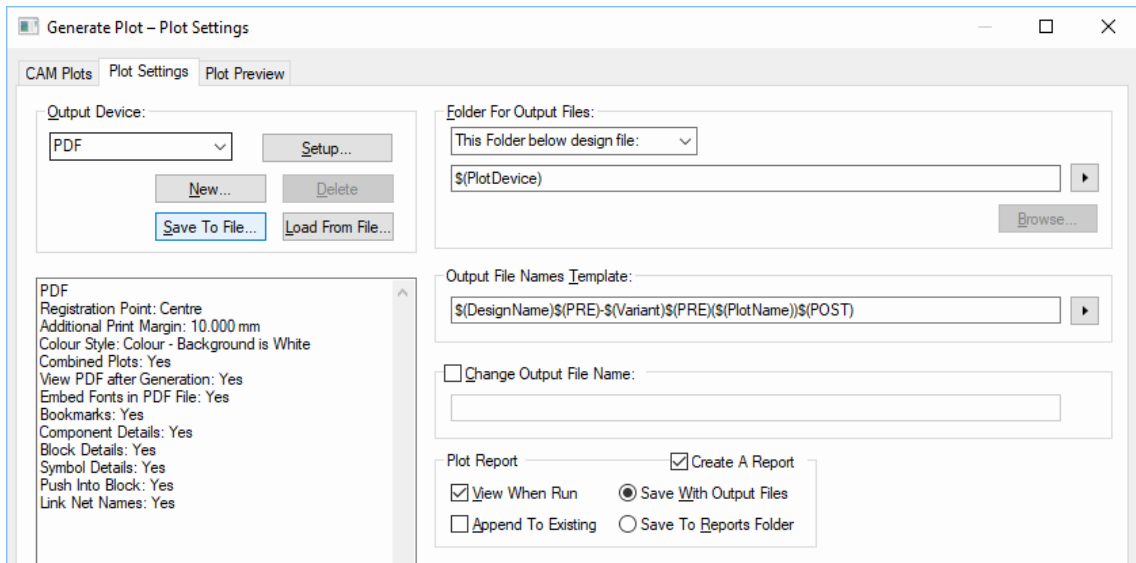

From the **Output Device** section of the dialog, you can view and change the settings for each kind of output device available. Use the drop-down list to choose the output device you wish to look at, and the current settings will be displayed in the large text area below.

If you need to change any of these settings, press the **Setup** button to access the Setup dialog for the output device. The actual dialog that is displayed is different for each kind of output device (Windows, HP-GL Pen etc.).

The **Folder For Output Files** section defines where the output files are written. You can choose from three different settings by selecting from the drop-down list.

Design Folder: output files will be written to the same folder as the design file.

This Folder: you specify the folder where all output files are written. The same folder will be used for all output files generated.

This Folder below design file: you specify a folder name that will be appended to the folder in which the design is stored. For example, if your design is stored in "C:\My Projects\Board 6\Revision 2.pcb", you can set the output folder name to "Plots" and all the output files will be written to the folder called "C:\My Projects\Board 6\Plots".

File Names Based On

This section allows you to choose the way your output files are named. You can choose from three different settings by selecting from the drop-down list.

Design Name: output file names will be based on the name of the design. A number will be added to the end of the name to generate a unique name for each file generated in any one plot "run".

Plot Name: the output file name will be derived from the Layer/Span/Page name of the plot. For example, a plot file that is generated by processing Layers will be named according to the layer name being plotted.

Design Name + Plot Name: plot files will be written to a file using the design name followed by the plot name (in brackets) and using the default extension for the type of plot. e.g. "MyDesign (Top Electrical).hp"

Change Output File Name

Use this if you want all output files to be based on a specified name. A number will be added to the end of the name to generate a unique name for each file generated in any one plot "run". If you leave the file extension off, the default extension for the type of plot being generated will be added. If you just type a file name with no directory, the mentioned above folder will be used.

Leave unchecked to use the above mentioned default plot file name.

Plot Report

Create a report use this switch to elect whether to write the CAM Plot report or not.

View When Run: You can choose whether the plot report that is written at the end of each run will be displayed on the screen after it has been generated.

Append To Existing: The plot report will normally be overwritten each time press **Run**. Check this option to append (add) to any existing report, instead of overwriting. You will then need to scroll to the end of the report to view information about the latest plot.

Save With Output Files: Use this to direct the plot report to be saved with the output files.

Save To Reports Folder: Use this to direct the plot report to the reports folder.

Outputting a plot

Once the **Auto Generate** dialog has been used, the bulk of the work to create a plot has been done apart from 'fine tuning'. The **Auto Generate** dialog has been designed so that any rotation, any scale plot to fit the page will be specified by default. This means the plot will fit the paper if the **Run** button is pressed. Obviously, you can use the CAM Plot dialog to redefine the plot as required.

Check that the plot is as required using the **Preview** dialog, and press **Run**.

Printing to Active PDF

The plot to PDF output is used to write PDF format file with active annotation. Once the PDF file is created, you can hover your cursor over design items and properties of that item will be displayed.

In a Schematic design, all pages in the design and hierarchy are plotted (including lower level hierarchical blocks).

Writing the PDF files

Within the CAM Plot option, the PDF output is additional to the standard Windows driver and you do not need to install a separate driver for it. If you have a PDF Windows driver already installed, you can still use it. The Pulsonix PDF driver has the added ability of the active annotation which your standard PDF output will not have.

The **PDF** output is accessed through the **CAM Plot** dialog and **New** or **Edit** when you create a plot. Simply select **PDF** from the drop down list of available output types.

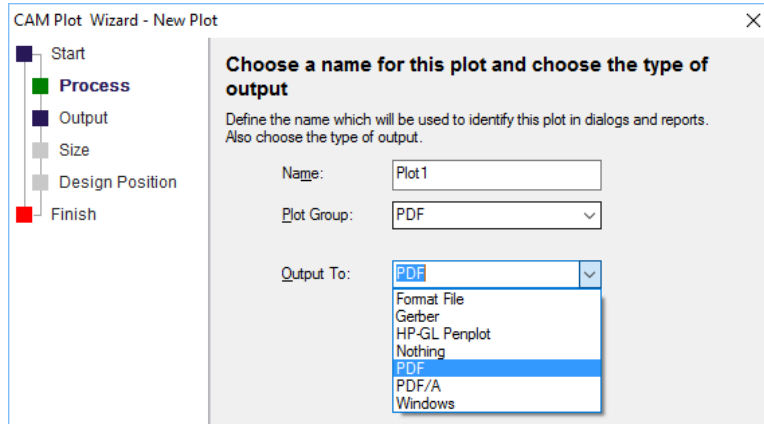

Using the PDF file once created

Once the PDF file has been created and it is open, you can hover your cursor over design items, such as Components or connections. A small context menu is displayed from which you can view entities of the item chosen.

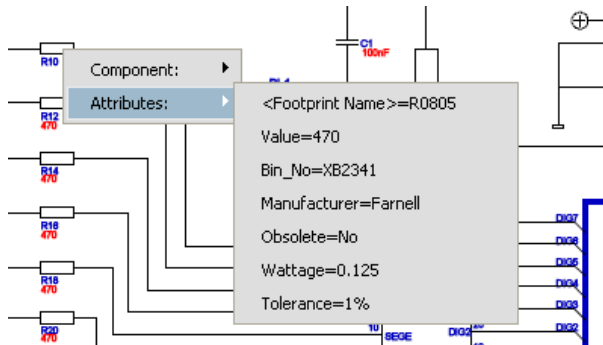

Setting up the PDF output

You can configure the PDF output using the device **Setup** option from within the **CAM Plot** dialog.

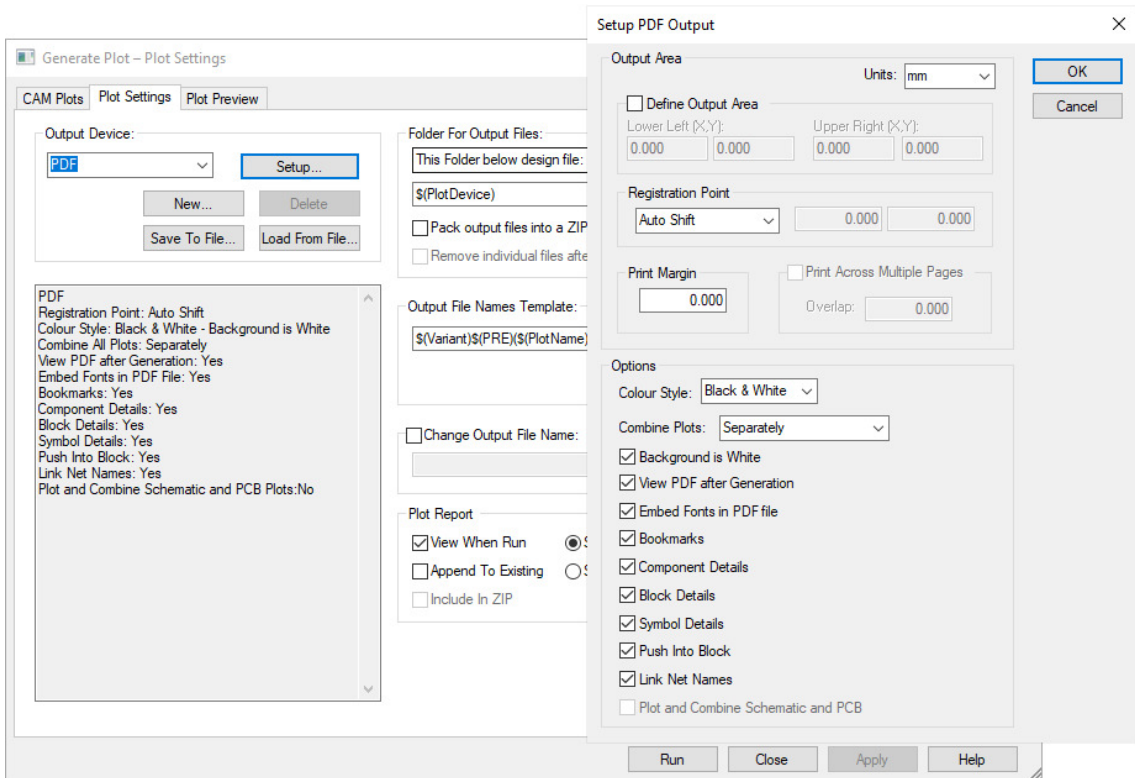

Two settings are of note for Schematic plots; the first is for combining or not combining plots. By selecting your requirements in **Combine Plots**, you can export individual plots for each Schematic page. This setting allows **All** plots to one PDF document and plot **Groups** as well as **Separately**.

The second setting to note is for combining both the Schematic design pages and the PCB design to one PDF plot file.

When running a combined plot, the program will either use the same name as the 'other' plot or will use the design name defined in the **Design Settings, Synchronise, Synchronise Design Name** option.

Chapter 6. PCB Design Editor

Getting Started with the Design

There are a number of ways to start a new PCB layout. The way in which you start will depend on, whether you have a Pulsonix Schematic design, a netlist or a sheet of paper with a Schematics design on it.

- Using Pulsonix Schematic Capture as the 'front-end' to the PCB system. The nets and components are translated to PCB in the integrated environment.
- Using a netlist that is derived from another CAE or Schematic system.
- Using the Pulsonix PCB design editor interactively creating the design on the fly. This means without an initial netlist just adding connections and components as you design the PCB.

This chapter will guide you through the different options that will enable you to build up the design in the order that you naturally progress the layout with.

Starting a New PCB Layout with Default Files

Regardless of where you start the PCB design from, you are required to provide basic information at the starting point. This would normally be the name of the **Technology file** and the **Profile file** you may wish to use, both of these files are optional and can be loaded at a later stage if required.

Obviously, how you start the PCB layout will be determined by how you intend entering the Component lists and netlist.

For the process of this discussion all methods will be explored but we start with the New PCB design.

► To start a new PCB layout

1. Click the **File** menu and click **New**.

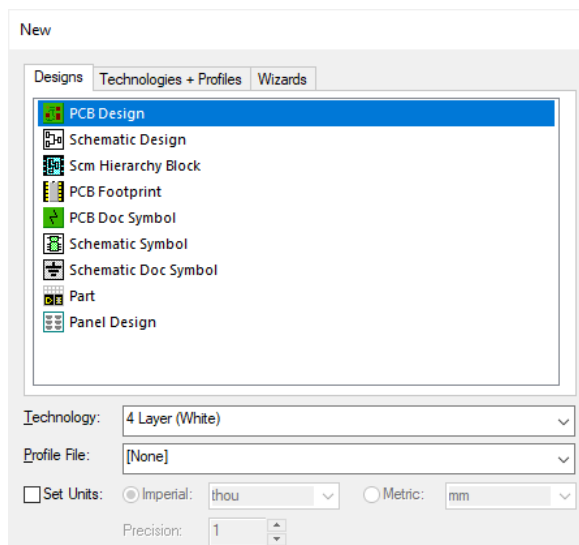

2. Click **PCB Design**
3. You will also be able to select the name of a **Technology file** in the drop down list box. There are a number of choices available as supplied with Pulsonix, each of which represents a different type of design technology, e.g. Double Sided, 4 Layer, etc. If the Technology file required does not match one of these you can select [**None**] from the list.

If you are unfamiliar with this style of drop down list, select the small arrow on the right hand side of the technology file name and then click on one of the names presented to select it.

4. You can also select the name of a **Profile File** from the drop down list box. The Profile file can contain your board outline or drawing blank etc. If you do not require a profile file or wish to add one later, select [**None**] from the list.
5. The **Set Units** check box enables you specifically select the units for your new PCB design. This overrides the Technology file units and will be subsequently used in the design. Choose from **Imperial** or **Metric** and select the precision required.
6. Click **OK** to start a new PCB design session.

The PCB editor is now ready with a Technology file loaded and optionally, a Profile ready for use. From here you may add a netlist (from another non-integrated system) using one of the supported netlist formats. Alternatively, you may wish to create the design on-the-fly adding Connections or Tracks and components directly.

At any point, you can load a full or partial Technology file, and load a Profile file. Partial Technology files enable you to mix and match technologies or to create Technology files of individual technologies, such as layer stacks or Spacing classes for SMD, BGA designs etc.

Later on in this chapter, methods for using the Translate from Pulsonix Schematics and using a netlist are discussed in more detail.

Design Setup for PCB Layout

Before getting started in the design itself, you should check that when you start adding design items, the design editor will behave as you expect or require it to.

Many of the characteristics of design items are set up in the **Design Settings** dialog and in particular on the **General**, **Defaults** and **Naming** tabs.

The **Defaults** pages set up the **Layers**, **Styles**, **Testpoints** and other feature options used when adding new items to the design. Access these pages through the **General/Defaults** page and **Edit Defaults** button.

Side:

Name Layer:

Name Style:

Name Stem:

Testpoint Type:

Part Name:

Doc Sym Name:

Free Pad Style:

Via Style:

Unless an item is pre-selected, the default style defined in this dialog is used. If a similar item is pre-selected, inserting a new item of the same type will inherit the Layers and style of the selected item.

The **Naming** page contains very specific information regarding the characteristics of design items, items such as the leading character or symbol used for the default system net names, e.g. whether \$001 or N0001 is used (or another leading character). Pulsonix uses \$ as its default leading character.

Force To Upper Case

Component Names

Gate Names

Net Names

Part Names

Pin Names

Test Point Names

Default Net Names

Name Stem:

Number Width:

Name Options

Case Sensitive Pin Names

Numeric Gate Names

Case Sensitive Drill Size Idents

Name Ranges

Range Start:

Range End:

Range Separator:

Item Separator:

Example: U1,U[3-6]

Pin Names

Component to Pin Name Separator:

This dialog is set with built-in settings and should only be changed if you understand what they do. Some of the settings can only be changed before a design is started, where there are no design items in the design. Some items can be changed after the design is started but the system updates itself to adjust all the design items that already used these settings, e.g. Default Net Name stem.

Segment Mode: Apply Seg Mode to Tail

Interactive Mitre/Fillet Auto Corner

Size: Any Angle Tolerance:

Show 'Can Finish' and 'Has Loop' Markers Remove Loops
 Show Legal Completion Path Auto Share Tracks
 Always Mark Net being edited Allow Nets to be Joined
 Clear Mark when edit complete End On Via - Adds Protected Via
 Show Connection to Nearest Node Use Style From Picked Track
 Show Dynamic Connections Only Obstacle Avoid
 Optimise After Edit Auto Finish
 Next Layer - Use Bias Change Layer - Return To Previous Layer

Double Click Operation

Complete Track
 Finish Here
 Finish On Via
 Swap Layer

Track Pushing
 Spring Back Push Vias
 Pull Tight Plough

Auto Correct Track

Mitre Result

Auto Necking

Auto Neck
 Pad Auto Neck

Add a Differential Pair Track Using:

Single Track Mode
 Mirror Mode
 Pairing Start Mode

Sketch Track

Use Point To Point Mode Mitre Result
 Use Grid When Sketching Use Any Layer

Track Hugging

Always Uses Minimum Gap

Hug Method: Shielding Routing Gridded

Area Based Styles

Stop at Border Until Clicked
 Automatically Change Style at Border
 Change Style at First Corner

The Default and naming options are saved in the design, and so only effect the design you are editing. Other options are saved to the system's Registry and so are set up for every design that you subsequently create or edit. They can be set up in the Technology files. Once your preferences have been worked out, the Technology files should be changed so that these options are then used for future PCB designs.

Once you start editing the design and adding new items to it, you can also check the **Options** dialog under the **Tools** menu to see if the **Edit Track**, **Move** and **Interaction** tabs are set to your preferences. These can be changed interactively during the tools use from context menu options. Pulsonix is a very flexible system and allows many of the options to be customised to suite your particular style of working.

Unlike **Design Settings**, **Options** are stored in the registry and are therefore machine or login specific, these are normally user preferences rather than design preferences.

Setting up a PCB Technology

The concept of Technology files has already been discussed in a previous Chapter. This section details the specifics of Technology data with the PCB Layout editor.

The most important considerations when choosing a Technology file or setting up your technology data is the final manufacturing process that your manufacturer can handle. A consideration to make when design your PCB is the cost of the technology you intend using. Changing your track styles from 8 to 6 thou for example, could have significant costs implications. You should always check that they can actually make the board you propose as well. For example, if you use blind and buried vias, not all manufacturers can make these in-house.

PCB Technology dialog

Styles

The PCB technology data contains a number of styles that define the appearance of PCB design items, (components/Documentation Symbols, Connections, Net Classes, Tracks, Copper, Names/attributes and Text).

The illustration below shows the major styles used in components and Doc Symbols, Connectors and Testpoints. Generally speaking, each symbol is made up of a collection of the same type of styles but in some cases not all of them.

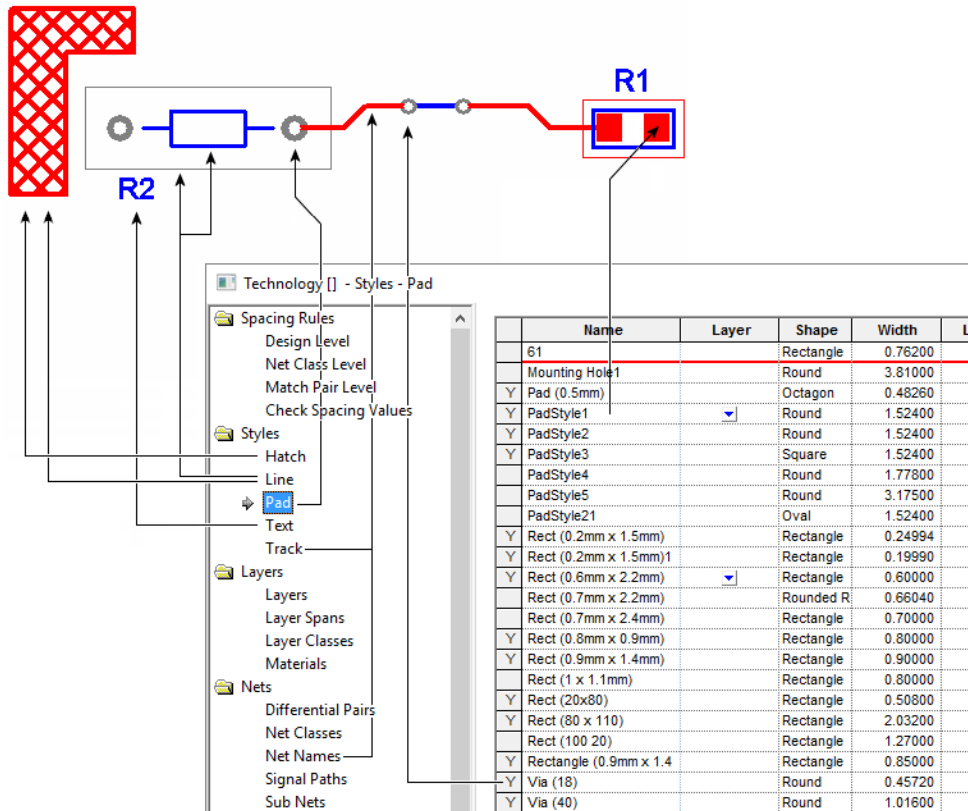

Pad Styles

Pad styles are used to define an electrical point of contact for nets and tracks but also as a physical pad for the Component. These can be any one of the predefined shapes available, and are defined a **Width** and **Length**, but can also include a **Drill Hole** if used as Through hole pad along with the drill hole **Plating** status.

User Defined Pads will show a shape of **Special** as they have been specially created. These are discussed below under the heading *User Defined Pad Shapes*.

The Name can be **Typed** by you as required or it can be defined from the Pad Naming **Rules** (defined in **Technology** under **Naming** and **Pad Style Naming**). **Template** is used to match a single rule for one pad style.

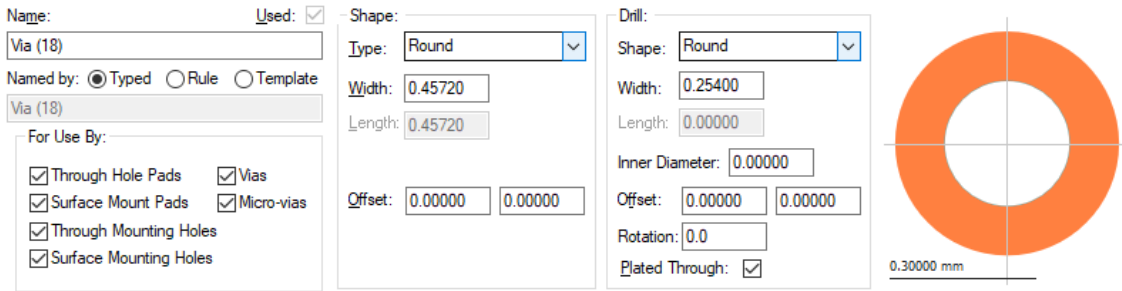

The **Shape** of a drill can be defined to provide slotted pads. Pads of **Round** are considered normal drill holes.

An **Offset** value can be defined for both X and Y offsets for the pad position. This enables you to display the pad in an offset position from the actual connection point of the pad.

An **Offset** value is also available for the **Drill** position. This enables you to define the position that the drill is located within the pad.

Vias are included in the **Pads Styles** dialog and are defined in the same way as normal pads.

For Use By enables you to preselect the refinement of the pad styles for when they are used. For example, creating a style used specifically for vias, such as Via (18) and choosing Vias from the list, this pad style will only be available for pad styles and not when adding pads or mounting holes.

Slotted Pads

If you wish to define a slotted pad style, you can do this using a User Defined Pad, or preferably, using a slotted pad style defined in the **Pad Styles** dialog. When editing a pad style, you will need to edit the Drill style to be an **Oval**, **Rectangular** or **Rounded/Chamfered Rectangular** drill style. This makes your 'drill' hole a 'slotted' style rather than a drilled style.

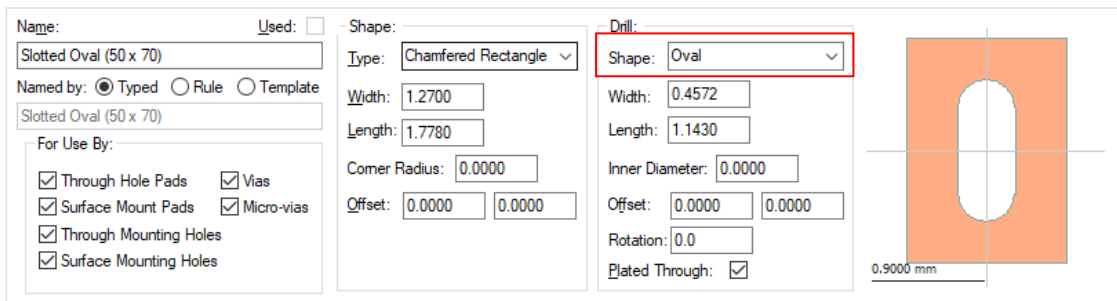

When in the **CAM/Plot** dialog, this pad style would be (generally) machined using the Excellon NC Drill output but would have a separate drill run for slotted pads, these would be milled rather than drilled.

On the Process page of the **CAM Plot Wizard**, the **Non Round Hole Shape** would be selected for output. You may have two separate outputs for **Plated** and **Non-plated Slotted** pads.

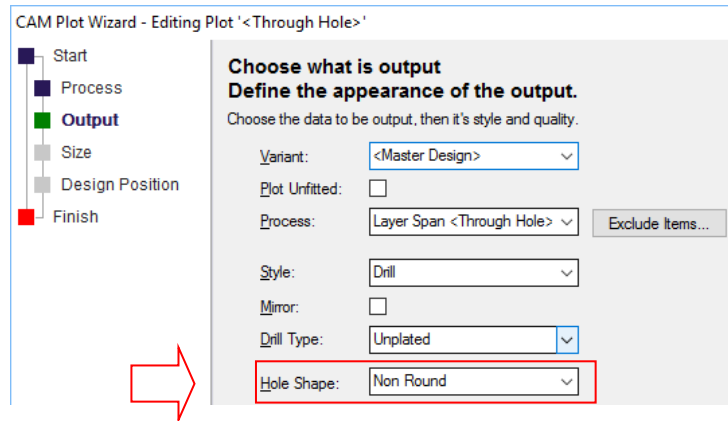

Line Styles

The **Line Styles** dialog is used for line widths of Component outlines, Placement outlines, Areas, Templates, Copper, Arrows, Thermal Spoke Widths and Board outlines.

Connection Style

Connection Line widths are taken from a system value and cannot be changed.

Track Styles

The **Track Styles** dialog is used to define the thickness of tracks. These styles are used when defined as a rule in the **Net Styles** dialog

The **Net Names** dialog is used to list the user defined net names used in the PCB. You can set a nets Net Class name using the Net Class dialog (see below).

User Defined Pad Shapes

User defined pads can be used where the standard Pulsonix pad shapes do not represent the actual pad shape required. A pad style editor is provided that is run from within the Pulsonix PCB design editor itself. This means you can create a special pad shape by drawing the actual pad shape and drill shape required. This mode may be used to create new pad styles or edit existing ones.

The **Define Pad Shape** mode is entered using the option from the **Setup** menu. This editor is similar to any other Pulsonix editor mode, such as the Footprint Editor. Obviously, it has limited functionality relative to creating pad shapes. When the pad shape editor opens, various shapes are shown, these represent the following:

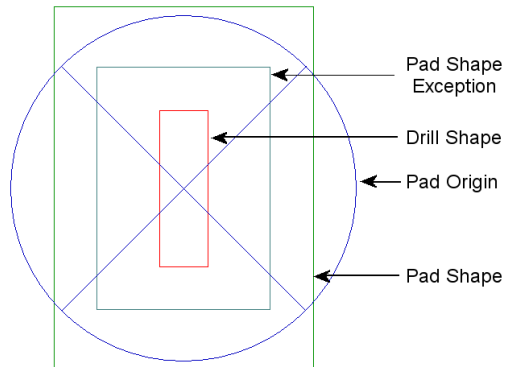

Edit an existing pad style in the Pad Shape Editor and you can delete, resize, move or edit the red circle drill shape. You are able to delete it first then add a new shape (a Rectangle, for example) to draw in a slotted pad. If you then select it, you can use **Change Layer** to select a new special layer of **<Drill Shape>**, this specifies the shape to be the drill hole.

To add a **Pad Exception** to your user defined pad shape (a different pad shape on another layer), simply add a new shape and use the **Change Layer** dialog to define its layer.

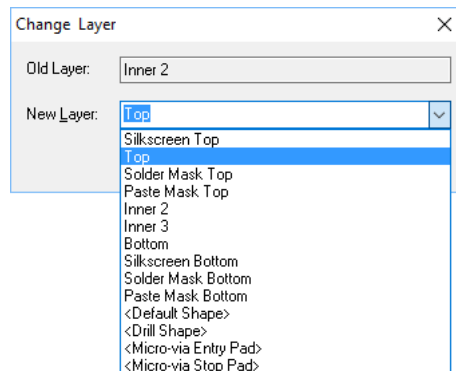

The **<Default Shape>** entry shown means that the selected shape will appear on all the layers in the layer stack unless changed to a specific layer.

Once the pad shape has been defined, from the **File** menu, use **Save** to save the shape and exit.

Define Pad Shape - Multiple Shapes Allowed

In **Define Pad Shape**, you can add multiple shapes for on a **Non-Electrical layer**. For example, to define multiple glue spots. This can be done by adding the extra shapes and changing their layer to an appropriate one.

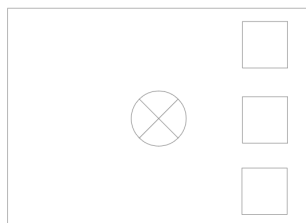

Define Pad Shape now contain Text, Dimensions and Callouts

When using the **Define Pad Shape editor** you can also add **Text, Dimensions, Construction Lines** and **Callouts, Properties, Technology Styles, Defaults** and **Colours** are available to support these documentation items.

Saving Documentation items for reuse

You can save all of these items within the Pad Shape so that they can be recalled for use on future edits. Effectively, for special Pad Shapes that have this additional information you will create a set of Pad Shapes in your library. **To save these Documentation items, you must save the Pad to a PCB Doc Symbol in a library.** If you choose not to save the Pad to a Doc Symbol then the additional information will be lost. Not saving the Pad Shape will still mean it retains any user defined shapes as before.

When saving back to a style in the PCB design, if the Pad Shape is in a library or if the Pad Shape contains documentation items, you are asked if you want to save to a Doc Symbol library.

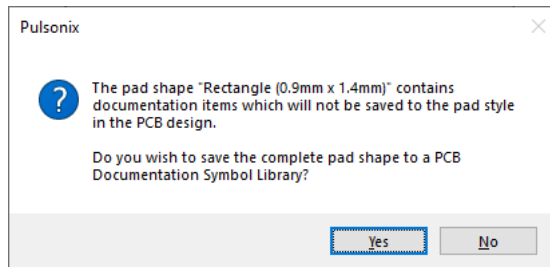

Choosing **Yes** will display the **Save To Documentation Symbol Library** dialog:

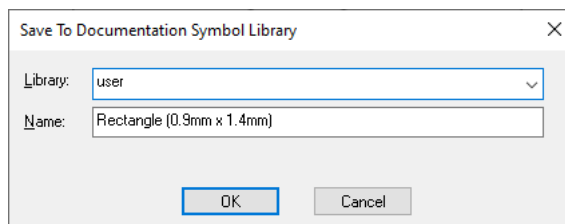

This can also be accessed from the File menu using the **Save To Library** option.

Choosing **No** will exit the Pad Shape editor, save the pad shape defined but will not save any of the additional documentation information, this will be lost.

User defined pad shapes can be added to the **Vault** as well as your **PCB Documentation Symbol Library**.

Saving a Pad Shape as a **Doc Symbol** will be saved as a new symbol type, **Pad Shape**. These can be edited the same as any other Doc Symbol and accessed from the **PCB Doc Symbol Library Manager**.

Load Pad Shape From Library

When editing PCB pad style, from in the **Footprint Editor** for example, if you wish to use a Pad Shape that has already been saved as a Doc Symbol, then for a selected pad, you can use **Load Pad Shape From Library** from the context menu.

If the pad style name is already in a library or vault you will be asked if you want to load it when first editing the style.

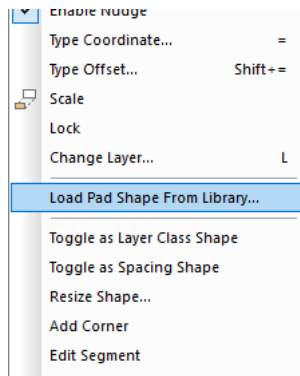

Hatch Styles

Hatch Styles is used to provide a mechanism for hatching Closed and Filled areas, e.g. Copper or Shapes etc. Hatching is an alternative to a solid and can be defined as either Hatching using a single line, or Cross Hatching using diagonally opposing lines.

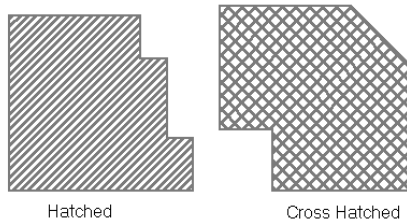

	Name	Angle	Coverage (%)	Cross Hatched	Width Percent	Offset Percent
	Cross Hatched	45.0	50	<input checked="" type="checkbox"/>	100.00	0.00
	Hatched	45.0	50	<input type="checkbox"/>	100.00	0.00

Name: Used:

Named by: Typed Rule Template

Cross Hatched:

Angle:

Coverage (%):

Width (%):

Offset (%):

The Name can be **Typed** by you as required or it can be defined from the Hatch Naming **Rules** (defined in **Technology** under **Naming** and **Hatch Style Naming**). **Template** is used to match a single rule for one pad style.

The **Angle** specifies the angle of the hatching. 0 is horizontal, 90 degrees is vertical. **Cross Hatched** causes a second set of hatch lines to be added, orthogonal (right-angles) to the first set. **Coverage %** specifies the percentage of the area covered by the hatch lines. This dictates the distance between hatch lines, which will be related to the thickness of the line style used and if it is **Cross Hatched**. A **Cross Hatched** area will have a greater line separation than a singly hatched area with the same **Coverage**.

For coverage where the spacing between the lines and the line thickness are the same, you should use a 50% coverage. Where a larger spacing is required, use a smaller % coverage. Where a smaller spacing is required, use a larger % coverage.

Offset (%) gives the offset of the hatch lines, given as a percentage of the line separation. Must be between 0 and 100%.

As the hatch style is edited, the preview window is updated automatically to show the style.

The Hatching or Cross Hatching will be created using the Copper **Line Style**. Thus if you change the Copper Line width where hatching is used, the proportions of spacing to line width will automatically change to reflect the current % coverage.

Style Naming Rules Pages in the Technology Dialog

Style Naming Dialog

As a switchable option, you can opt to have Pulsonix automatically create style names for you. This means that, for example, when creating new pad styles, you could use the auto-naming option to use the IPC naming convention.

Style Naming is available for all **Styles** within the Technology dialog. Each page works like any other Rules page within the Technology except that generally speaking, you'd only ever have one or two rules for each naming style.

Line Pattern	Match Line Width	Line Width	Template String
Solid	<input type="checkbox"/>	0.00	Line <pattern> <width>

The edit portion of the dialog is used to define specific naming items, this varies for each item style. The right side of the edit pane defines the **Rule** that will be created. Once the rule has been defined using keywords selected from the **Field:** drop down list, use the **Insert** button to add it to the Rule.

Line Pattern: <Any> ▾

Match Width

Less Than or Equal To: 0.00

Rule: Line <width><metric>

Field Keyword

<width>

Field: Line Width ▾

Pre-text:

Buttons on the Navigation bar under **Replace All:** enable you to add a rule to the rules pane replacing any existing rules. A button on all pages (**Basic Set**), is used to set up a basic rule for you to use. This can be edited to your own style if required. On the **Pad Style Naming** page, an extra button (**IPC Set**) is used to define a more complex string for the IPC naming rule.

Basic Set & IPC Set Buttons

On each of the pages is a button named **Basic Set**. On the **Pad Style Naming** page, there is an additional button for the **IPC Set**. These buttons are under the heading **Replace All:** and are used to create you a basic style naming rule tailored for each of the particular styles. As it says, using this button will add you one style naming rule to the grid and will remove all other rules defined. The rule won't be applied until the **Apply** or **OK** buttons are used at the bottom of the dialog.

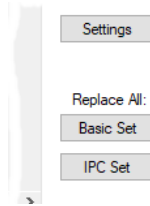

Note: When using the **IPC Set** button, this also sets up the **Settings** dialog as well as the rule definition. The IPC rule is a combination of both the rule and pad style/usage mappings.

Style Naming Settings Dialog

Each of the Style Naming dialogs has a **Settings** button. Each one is the same except for Pad Style Naming which has additional settings that can be used. The Settings dialog defines the **Units** and **Units Text** for the Style Naming. This is independent of the main **Design Units** dialog and is only used for Style Naming.

The **Pad Style Naming Settings** dialog also enables additional **Mappings** for **Shapes** and **Pad Usage**. This is used where specific styles require mapping so that can be correctly defined, the IPC naming style for example.

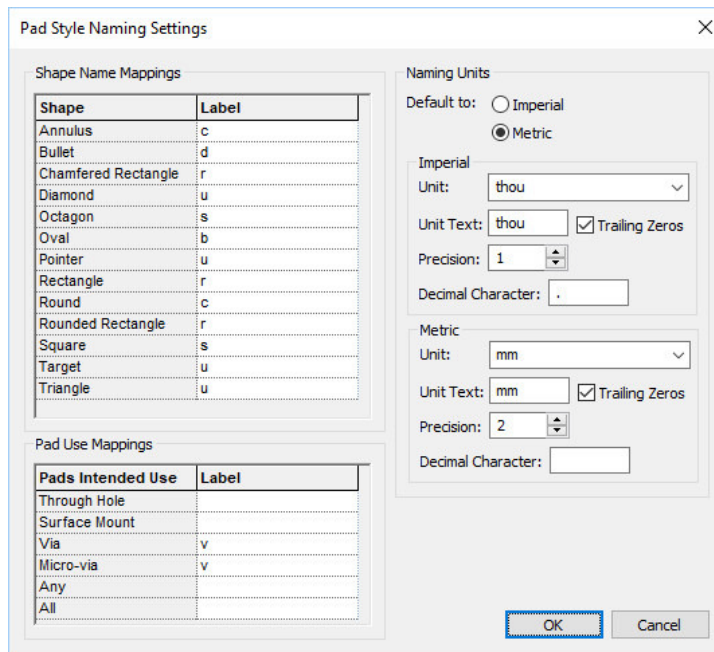

Technology Styles Dialog

In addition to the Style Naming dialog for each of the styles, the actual **Style** page has been modified too to enable the naming.

Under each of the **Name:** fields for the style, there are now three additional radio buttons to define how the style will be **Named by:** There is a choice of **Typed** (manually named), **Rule** (using the new Style Naming rules for that style item) and **Template** (which is a hybrid, a combination of both Rule and Typed).

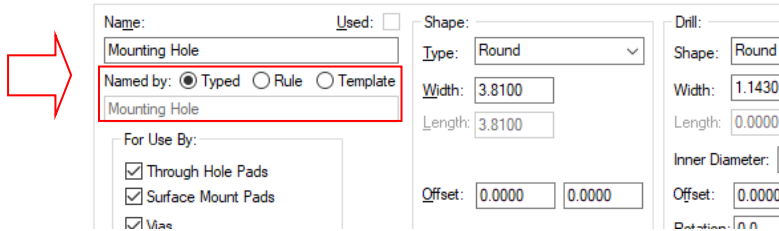

Name: Used: Shape: Drill:

Type: Round

Width: 3.8100

Length: 3.8100

Offset: 0.0000 0.0000

Named by: Typed Rule Template

Mounting Hole

For Use By:

Through Hole Pads

Surface Mount Pads

Via

Technology General/Defaults Dialog

From with the **Technology** dialog and **Design Settings, General/Defaults** page, there is an additional switch related to **Style Naming** called **Make named styles use naming rules**. When selected, this will force the addition of new named styles use the naming rules. Leaving it unchecked enables a **Typed** rule to be defined.

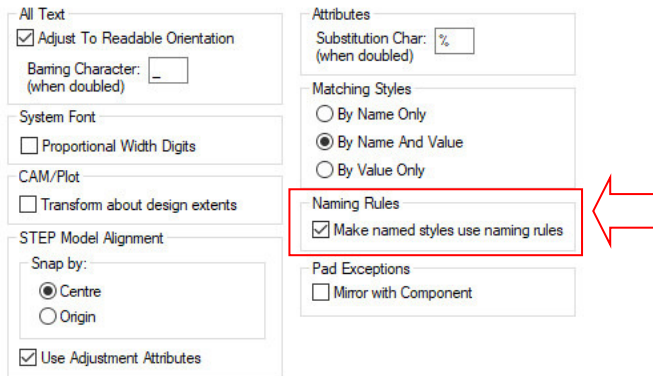

All Text

Adjust To Readable Orientation

Baring Character:

System Font

Proportional Width Digits

CAM/Plot

Transform about design extents

STEP Model Alignment

Snap by:

Centre

Origin

Use Adjustment Attributes

Attributes

Substitution Char: (when doubled)

Matching Styles

By Name Only

By Name And Value

By Value Only

Naming Rules

Make named styles use naming rules

Pad Exceptions

Mirror with Component

Spacing Rules

The Spacing Rules dialog is used to specify the minimum clearances required between different kinds of electrical design items. The spacings you set up in this dialog are used by the **Design Rules Check** to calculate whether or not any of the electrical items in your design are too close together.

Using the Spacing Rules dialog

The spacing values are presented in a grid, allowing you to easily change the values directly.

Design	Design								
	Track	Pad	SMD Pad	Via	Micro-via	Testpoint	Mounting Hole	Copper	Text
Track	6.0	6.0	6.0	6.0	6.0	6.0	6.0	6.0	6.0
Pad	6.0	6.0	6.0	6.0	6.0	6.0	6.0	6.0	6.0
SMD Pad	6.0	6.0	6.0	6.0	6.0	6.0	6.0	6.0	6.0
Via	6.0	6.0	6.0	6.0	6.0	6.0	6.0	6.0	6.0
Micro-via	6.0	6.0	6.0	6.0	6.0	6.0	6.0	6.0	6.0
Testpoint	6.0	6.0	6.0	6.0	6.0	6.0	6.0	6.0	6.0
Mounting Hole	6.0	6.0	6.0	6.0	6.0	6.0	6.0	6.0	6.0
Copper	6.0	6.0	6.0	6.0	6.0	6.0	6.0	6.0	6.0
Text	6.0	6.0	6.0	6.0	6.0	6.0	6.0	6.0	6.0
Board	50.0	50.0	50.0	50.0	50.0	50.0	50.0	50.0	50.0

Click on the text of the value you wish to change, and edit the text to show the required value. You can also take the value from one cell and apply it across the whole row, down the whole column, or to

all the cells of the whole grid, by right mouse clicking and selecting the required option from the context menu.

As an additional ‘lower’ level of spacings available, **Net Class Level Rules** enable you to specify spacing rules based on Net Classes. You also have the ability to specify rules based on **Net Name** and **Net Attributes** using the **Match Pair Level Rules** spacing. This dialog enables you to define **Layer** and **Area** based rules as well.

Special Design Level Rules

Design Level Rules contains additional tabs for specific items spacings.

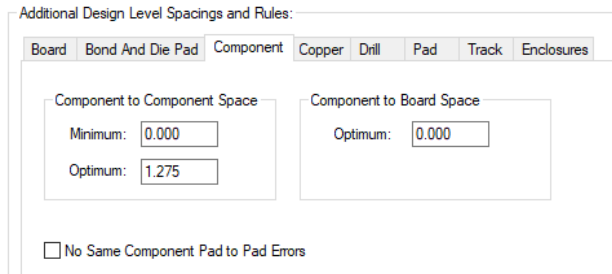

Component rules defines the **Component to Component** spacing. This is used as the minimum space is used by the **Design Rule Check** option to look for overlapping components. The **Optimum** space is used when using **Push Aside** whilst manually moving components, in order to space the components out a little. The spacing rules value is applied to the boundary extents of the Component. It is more efficient, and easier to manually place, any components that contain a placement outline defining its boundary. This boundary would be defined at the Footprint creation stage and would be drawn using an area shape.

Match Pair Level Rules

These Rules are similar to the **Net Class Level Rules**, except they only apply between two net items.

Item 1		Item 2		Side	Layer	Area
Attribute Name	Match Value	Attribute Name	Match Value			
<Net Name>	HS*	<Net Name>	*			
<Net Name>	Sig*	<Net Name>	*	Inner		

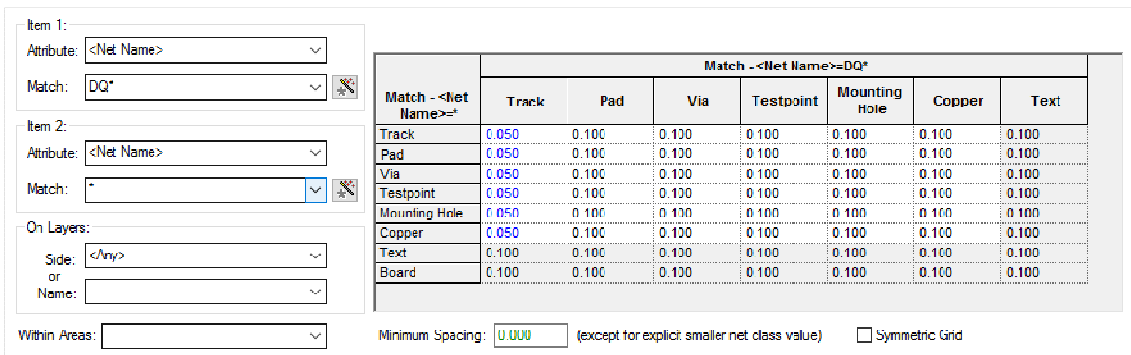

The **mm** check box at the bottom of the dialog enables you to set the units to mm or thou (Mils) within the dialog only and overrides the main **Design Units**.

To use this dialog, you must define the **Net Item** the rule applies to. To do this, press the **New** button. You should select the two Net items, you can also use a wildcard string to match several items.

You can also specify if the rule applies to electrical layers. These can be defined as **Top**, **Bottom** or all **Inner/Outer** electrical layers. Rules can also be defined for an area(s).

For example, if you have net classes called *Ground*, *Power +5 & Power +12*, you could define a rule pair between *Ground* and *Power**, so the rule would apply between *Ground* nets and all *Power* nets (but does not say anything about rules between *Power +5 & Power +12*).

The rules are applied in the order they are shown looking down the list, so if more than one matches, only the first match will be used. You can use the **Up** and **Down** buttons to move the selected rule pair up and down the list. The **Delete** button deletes the selected rule pair.

Colour Coding For Match Pair Spacing Grid

The grid is colour coded to show what values apply:

Black shows values inherited from **Design Level**

Green for **Minimum Spacing**

Blue for an explicit value

You can change a Spacing value back to the default by selecting the value in the grid and deleting it. An explicit value can be removed by deleting it.

Import Spacings Rules using CSV Format Files

From within the **Spacing Rules** dialog, you can import **Class to Class Spacing Rules** into the Schematic or PCB design **Technology** using a CSV file.

Using the Import CSV feature

The **Import CSV** button appears on the **Spacing Rules Match Net Class Pair** rule level dialog. This would be used in conjunction with the **Export CSV** option which would have exported a set of rules as a template ready for editing.

There is also a button for **Import Custom CSV**. This option allows different styles of CSV files to be imported. Currently, this accommodates a number of format 'styles' that have been seen within our development department.

The screenshot shows the 'Spacing Rules' dialog box. On the left, there are fields for 'Item 1' and 'Item 2', both with 'Attribute: <Net Name>' and 'Match: Sig*' (with a wildcard icon). Below these are 'On Layers' options: 'Side: Inner' and 'Name:'. At the bottom left is 'Within Areas:'. In the center is a table with the following data:

Match - <Net Name>=*	Match - <Net Name>=Sig*						
	Track	Pad	Via	Testpoint	Mounting Hole	Copper	Text
Track	8.00	8.00	8.00	8.00	8.00	8.00	10.00
Pad	8.00	8.00	8.00	8.00	8.00	8.00	10.00
Via	8.00	8.00	8.00	8.00	8.00	8.00	10.00
Testpoint	8.00	8.00	8.00	8.00	8.00	8.00	10.00
Mounting Hole	8.00	8.00	8.00	8.00	8.00	8.00	10.00
Copper	8.00	8.00	8.00	8.00	8.00	8.00	10.00
Text	10.00	10.00	10.00	10.00	10.00	10.00	10.00
Board	10.00	10.00	10.00	10.00	10.00	10.00	10.00

At the bottom of the dialog, there is a 'Minimum Spacing: 0.00' field (with a note '(except for explicit smaller net class value)') and a checked 'Symmetric Grid' checkbox. The bottom bar contains buttons: 'Export CSV...', 'Import CSV...' (highlighted with a red box), 'Import Custom CSV...', 'mm', 'OK', 'Close', 'Apply', and 'Help'.

When selected, the **Open CSV** file dialog is displayed. You will be prompted to select the CSV file to import. The **File of Type** drop-down list is set to *.CSV.

*Note: If you have been editing your spacing rules in Microsoft Excel for example, you will need to save the rules into a CSV file format. To do this, when using the **Save As** option select **CSV (Comma Delimited) (*.CSV)** format from the **File of Type** drop-down list.*

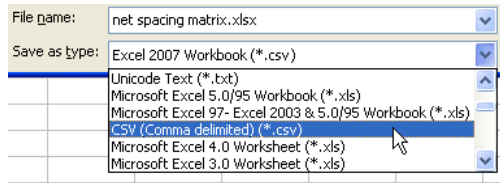

Select the file required from the dialog and press **Open**. From here, you can edit the rules presented.

The Import CSV Report

The **Report** button on this dialog can be used before running to inform you of what will be imported and a report will be created after import to tell you what has been imported. You can also run it a third time to verify the original file against the current Spacing contents, to check for differences. This way you can use this feature to check for any different values from the original spacings spreadsheet.

DFM/DFT Rules

Further tabs contains rules for functionality for: **Copper Pour**, **Footprint rules**, **Teardrops**, **Test Points** and **Thermal rules**. These are considered DFM/DFT rules (Design For Manufacturing and Design For Test).

Copper Pour

Copper pour rules are using to ‘pour’ copper into a Template shape. This would be used in association with the **Thermal Rules** dialog also.

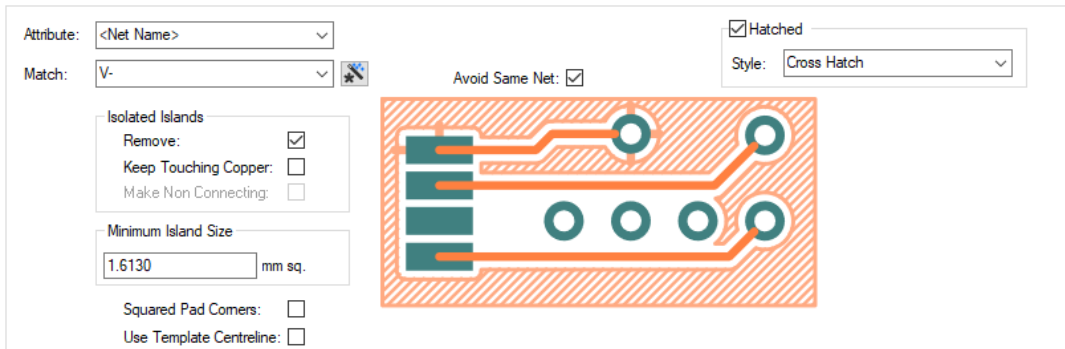

For the **Copper Pour** area, the **Avoid Same Net** check box causes tracks and copper on the same net as the Template to be avoided, so the only physical connections to the poured copper are through the pads. Otherwise, the copper will flood over such items. The **Minimum Island Size** is in the current design units *squared*, this defines the minimum area of a piece of copper generated by Copper Pour. **Remove Isolated Islands** means that each piece of generated copper must be connected to the designated Net. If no connection is possible, the island will be deleted.

You can define a **Hatch Style** to be used with each piece of copper generated.

Teardrop

Use the **Teardrop** options to change the shape and size of new teardrops to be added.

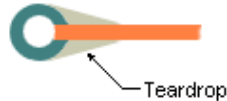

Attribute: <Net Class Name> ▾

Match: * ▾

On Layers:

Side: <Any> ▾

or

Layer: ▾

Within Areas: ▾

Shape: Triangle ▾

V Angle: 60.0

Use Length: 0.000

Apply Teardrops To:

Through Hole

Surface Mount

Vias

Micro-vias

Round Pads Only

You have a choice of teardrop shapes depending on your requirements - **Triangle**, **Curved Triangle** and a **customised length Triangle**. The **V-Angle** allows you to define the length of the teardrop based on its angle between the two items. A 60 degree angle is set as the default but can be changed as required. By adding **Length**, you can extend the 'V' to elongate it.

Once the teardrop has been added, the Shape and V-Angle can be interactively changed using **Properties** on the item. You should select the teardrop(s) first and then select Properties to change this value.

Thermal

The **Thermal Pads** parameters are used when using **copper pour** on pour areas of the design and when using the automatic power plane generation in the **CAM/Plot** option.

We define the following major items with refinement available in the **Thermal Rules** dialog.

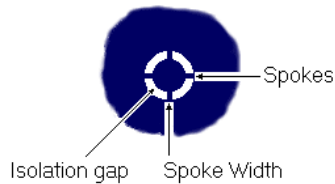

Thermal Rules are available in the **Technology** dialog:

Attribute: <Net Name> ▾

Match: * ▾

Applies To: Any ▾

Min Pad Size: 0.000 ▾

On Layers:

Side: <Any> ▾

or

Layer: ▾

Within Areas: ▾

Connect Type: Thermal Pad ▾

Enclosed Pads Only:

Orthogonal Spokes:

Isolation Gap: 0.254

Number Of Spokes: 4

Minimum Spokes: 2

Try Alternative Rotation:

Rotate With Pad:

First Spoke Angle: 0.00

Spoke Style: 0.127

<Thermal Relief Spokes> ▾

The **Isolation Gap** is the gap between the Pad and Copper plane creating the isolation. The **Spoke Style** is the small copper line connecting the Pad to the Copper area. This value is taken from the

Line styles entries in the **Technology** and is presented in the drop down list, this then displays the Spoke Style width. A value can also be typed in if preferred.

The **Number Of Spokes** connecting the Pad to the Copper area.

The **First Spoke Angle** is in current angle units (other spokes will be relative to this first spoke). The **Number Of Spokes** will be the total number added to each pad. A number of 4 or 5 is normal but this will depend on your manufacturer. The **Minimum Spokes** value is set if you really do have a minimum number required. If the minimum number cannot be reached, then no spokes are added to that pad. You should run the **Net Completion Report** to ensure that all pads are connected to the plane.

Testpoint

The **Testpoint** rules are used during the Testpoint Analysis when using **Auto Insert Testpoint** and **Insert Testpoint**.

Testpoint rules are defined in the **Technology** dialog:

The screenshot shows the 'Technology' dialog box for configuring testpoint rules. It is divided into several sections:

- Attribute:** A dropdown menu set to '<Net Class Name>'.
- Match:** A dropdown menu with a '*' symbol and a 'No Match' icon.
- Min Probe Count per Net:** A numeric input field set to '0'.
- Probe On:** A list of checkboxes: 'Through Hole' (checked), 'Surface Mount' (checked), 'Vias' (checked), and 'Micro-vias' (checked).
- Probe Side:** A dropdown menu set to 'Bottom'.
- Diagram:** A small illustration showing a testpoint probe connected to a pad on a PCB.
- Global Testpoint Rules:** A sub-dialog containing:
 - Testpoint to Component Space:** Minimum: 0.0, Optimum: 0.0.
 - Testpoint Land Size:** Minimum: 0.0.
 - Testpoint Centre Space:** Minimum: 0.0.
 - Testpoint Grid:** Attribute: (dropdown), Step: X=100.0, Y=100.0, Origin: X=0.0, Y=0.0.

The **Probe Side** under **Test Points** allows you to select **Top**, **Bottom** or **All**. These are used during the manual inserting of Testpoints and when using the **Design Rules Check** option. The **Side** can also be extracted using the **Report Maker** for reports of a specific testpoint side.

CAM Plot

The **CAM/Plot** pages and dialog are covered in detail in the Chapter on *PCB Manufacturing Tools*.

Layers

The Pulsonix PCB design system supports an unlimited number of layers in any combination of Electrical, Non-electrical, Wire, Construction and Documentation layers. These layers are used to detail the physical 'make-up' of the manufactured printed circuit board.

A typical default layer configuration

Below is an illustration of a typical 4 layer PCB showing the 4 electrical layers, 2 outer layers - Top and Bottom and the inner power plane layers - Ground and Power. As well as electrical layers, you may also need non-electrical layers for additional manufacturing processes that are not constructed as physical layers. A typical requirement for this type of layer might be a Silkscreen layer that is printed on top of the Top electrical layer.

For additional information that is not a manufactured process, you may require an additional layer; this can be added as a Documentation layer. This layer might contain the board build information for example that is used by the manufacturer to inform him how to build the board itself.

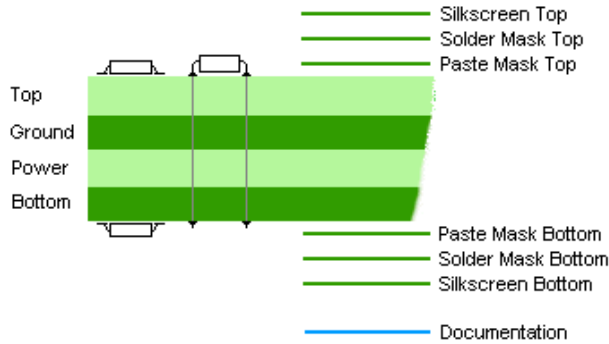

Pulsonix also supports a more advanced layer structure where the actual construction layers are defined as well as the basic layers. Layers such as the fiberglass board (FR4) or the copper attached to it, can be defined, as can their thickness and materials. You can also specify Wire layers for jumper wires and die pads (when using the Chip Packaging toolkit option).

How to set up layers

If using one of the supplied default technology files the layers are already defined for you, these can be edited or modified though as you require. If you wish to check or edit the layers on one of the boards, you can do so using the **Layers** tab on the **Technology** dialog. Once Layers have been changed, you can save these to a new Technology file or you can overwrite the original Technology file.

	Name	Associated Layer	Class	Side	Bias	Net	Material	Thickness
Y		Silkscreen Top	Silkscreen	Top	None			0.0000
Y	Top		Electrical	Top	X		Copper 1oz	0.0350
		Solder Mask Top	Solder Mask	Top	None		Mask (0.025)	0.0250
		Paste Mask Top	Paste Mask	Top	None			0.0000
Y		Pin Names	Non-Electrical	Top	None			0.0000
	Prepreg A		Construction		None		Prepreg (0.11)	0.1100
	Prepreg B		Construction		None		Prepreg (0.11)	0.1100
Y	Inner 2		Electrical	Inner	Y			0.0000
	Substrate		Construction		None		FR4 (1.0)	1.0000
Y	Ground		Power	Inner	Power Plane	Gnd	Copper 1oz	0.0350
	Prepreg D		Construction		None		Prepreg (0.11)	0.1100
	Prepreg C		Construction		None		Prepreg (0.11)	0.1100
	Power		Power	Inner	Power Plane	VCC	Copper 1oz	0.0350
	Inner 5		Electrical	Inner	X			0.0000
Y	Bottom		Electrical	Bottom	Y		Copper 1oz	0.0350
Y		Silkscreen Bottom	Silkscreen	Bottom	None			0.0000
		Solder Mask Bottom	Solder Mask	Bottom	None		Mask (0.025)	0.0250
		Paste Mask Bottom	Paste Mask	Bottom	None			0.0000
Y		Pin Names (Bottom)	Non-Electrical	Bottom	None			0.0000
	Board		Board		None			0.0000
	Construction Lines		Documentation		None			0.0000
	Documentation		Documentation		None			0.0000
	Drill Drawing		Drill Drawing	<Through Hol	None			0.0000

New...

Delete

Delete Unused

Up

Down

Reflect

View Layers...

Only Show Used Entries

Physical Copper Layers: 6

Board Thickness: 1.6300

The **Layers** dialog allows you to position the layers in the order that they appear in the finished PCB. These are easily positioned by selecting the layer first and then using the **Up** and **Down** buttons, it is advisable to use the build order for the layers in this dialog as it makes it easier for anyone else reading the Layers dialog to understand the layer construction. The layers must be grouped by 'side', so all the 'Top' layers are first, followed by the 'Inner' layers, then 'Bottom'.

This dialog enables you to add new layers or edit existing ones in the design. Not all of the items in this dialog are mandatory, but the following are: **Name**, **Class**, **Side** and **Bias**. These describe the layer Name to identify it, how the layer will look and plot, which side of the physical board the layer resides and the routing bias or usage of the layer.

Each grid cell is editable or has a drop down list that contains selections of relevant information.

When a **Power Plane** layer is specified (by selecting **Powerplane** in the **Bias** box) you should associate it with a power net, such as **GND**. Use the **Net** drop down list to choose the net name.

The **Colour** box allows you to change the default colour for that layer. Once set the colour can be edited using the **Colours** dialog.

The **Material** and **Thickness** of the layer allows you to complete the board for manufacturing purposes, but is not essential.

Layer Classes are used to define the type of layer that will be added. Pulsonix is supplied with predefined Layer Classes, but you can add your own if required.

Layer Classes

Layer Classes contain information about how the layer will appear on the screen and when plotted. By using these, it allows you to define additional characteristics of any new layer added to the design, or to change existing ones by simply changing to another Class. It also provides a mechanism for defining the items which are plotted when using the CAM/Plot output.

	Name
	Assembly
Y	Board
Y	Construction
Y	Documentation
	Drill (Non Plated)
	Drill (Plated)
Y	Electrical
Y	Non-Electrical
Y	Paste Mask
Y	Power
Y	Silkscreen
Y	Solder Mask
Y	Wire Link

The **Layer Class Edit** dialog contains information about the visibility of Pad items on the layer and the type of pad (Pad Condition) that appears e.g. SMD or through hole. This dialog is also used to set up the plotting over or under size when the layer is used for such types as Solder Paste Mask or Solder Resist.

The **Layer Type** is always one of five types: Construction, Electrical, Non-electrical, Wire or Documentation and cannot be changed, (Electrical layers are used to hold Electrical items such as tracks, copper etc. These are checked during **Design Rules Checking**). You have to always specify one of these layer types from the choice in the drop down list. The Layer Type will be selected based on its use in the design. The sample Technology files supplied already have these defined as a guide to their use.

If a Footprint contains items on an Essential layer, it cannot be added to a design which does not contain a matching layer. Similarly, items on non-essential layers will not be added to a design without a matching layer, but the Footprint itself can still be added. This can be useful for construction lines, dimensions or alternative outlines. Use the **Essential For Manufacture** button to enable this.

Materials

Activated from the **Layers** dialog, the **Materials** dialog is used to specify the material type that the layer is made of. For example, a construction layer could be made of **FR4** fibreglass material, or the 'glue' layer used between two **FR4** laminates could be a **Prepreg 2125** material.

	Name	Thickness	Electrical Conductivity	Dielectric Constant (Er)	Special Use
	Copper 1.2oz (0.018)	0.018	595900		
Y	Copper 1oz (0.035)	0.035	595900		
Y	FR4 (0.2)	0.200		4.3	
	FR4 (0.3)	0.300		4.3	
	FR4 (0.4)	0.400		4.3	
	FR4 (1.0)	1.000		4.3	
Y	Mask (0.025)	0.025			
	Plating	0.030+	595900		Hole Plating
Y	Prepreg (0.11)	0.110		4.2	
	Thin Plating	0.020+	495900		Micro-Via Hole Plating

Name:

Used:

Thickness:

Electrical Conductivity: S/m

Dielectric Constant (Er):

Special Use:

This is used by Pulsonix to create a fully documented layer structure for documentation purposes and also for the Design Calculators. For normal Pulsonix use, this level of detail is not mandatory.

Pulsonix is supplied with different **Technology files** containing different layer configurations. If, when using a technology file, you find that it does not contain the layers required, you can edit the existing technology to add more layers, or use the Load Technology option to load a different technology file, that does have the correct number of layers.

You can also import **Materials** (as well as **Layers**, **Layer Classes** and **Impedance rules** from an **IPC-2581 Layer Stackup** file produced by 3rd party products, such as Polar Instruments. This is available from the **Technology** page and **Layers** dialog using the **Import** button.

Layer Spans

A **Layer Span** defines the possible layers a **Via** can penetrate through the board. Often these are right through the board, from the Top to the Bottom Electrical layer. You can also have **Blind** vias (where the via goes from the Top or Bottom to an Inner layer), and **Buried** vias (where the via goes between two Inner layers). As these require an additional drilling process during board fabrication, you should consult your manufacturing house to check if they can handle it and the cost, as it can be an expensive process.

Layer spans are also used for **board outlines** to create **Flexi-Rigid Boards**, and for **Board Cutout Areas** to create **Board Cavities** and also areas spans if you have the Advanced Technology option.

► To set up through-hole layer spans

Layer Spans are setup using the layers already defined in the **Layers** dialog, these are used to define spans used for Vias and Micro-vias. Under normal circumstances, the <Through Hole> technology spanning the complete design, regardless of the number of layers, would be defined using the <Top Side> and <Bottom Side> layer spans. This would encompass any layers used in the design.

	Name	From Layer	To Layer	Type
Y	<Through Hole>	<Top Side>	<Bottom Side>	Through Hole
	Blind Top > Inner 2	<Top Side>	Inner 2	Blind from Top
	Blind Bottom > Inner 5	Inner 5	<Bottom Side>	Blind from Bottom

To create a layer span if not already defined in the technology file, use the **New** button.

Choose the **From Layer** and **To Layer** spans from the **Layers** available in the drop down list, this dialog will not allow duplicate layer spans to be created. It will allow overlapping spans but will warn you when you press **OK** and when you exit the **Technology** dialog.

► To set up blind and buried layer spans

For more advanced PCB technologies, blind and buried vias can be defined in the design.

Again, using the **Layer Span Edit** dialog the layer spans can be defined for blind and buried via technologies.

In the diagram below, the <Through Hole> technology has been set up as a system default (denoted with the brackets < >). The dialog shows a 4 layer example of 2 outer layers and 2 inner power plane layers. The span **Blind Top - Ground** has been set up to allow vias to be placed between the Top layer and the Ground power plane. This example would be used for connecting surface mount devices through a stub route to the power plane using a via.

	Name	From Layer	To Layer	Type
Y	<Through Hole>	<Top Side>	<Bottom Side>	Through Hole
	Blind Top > Inner 2	<Top Side>	Inner 2	Blind from Top
	Blind Bottom > Inner 5	Inner 5	<Bottom Side>	Blind from Bottom

This example is manufacturable and would look like this as a cross section of the finished PCB:

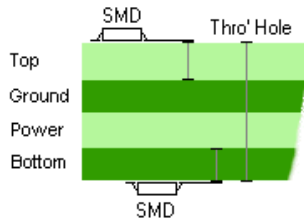

If an extra 2 layers in-between the Ground and Power layers were introduced, these could be connected together through a layer span and could only be connected to other layer spans if subsequently manufactured in a specific order. There would be layer combinations using these layers that would not be manufacturable but they are allowed under warning. The dialog will check for legal layer spans and warn you if un-manufacturable.

Displaying Layer Stacks

You can view the Layers, Via stacks and layer spans by selecting the **View Layers** button from the **Layers**, **Layer Spans** and **Back Drill Spans** dialogs (Back Drills when using the High speed option).

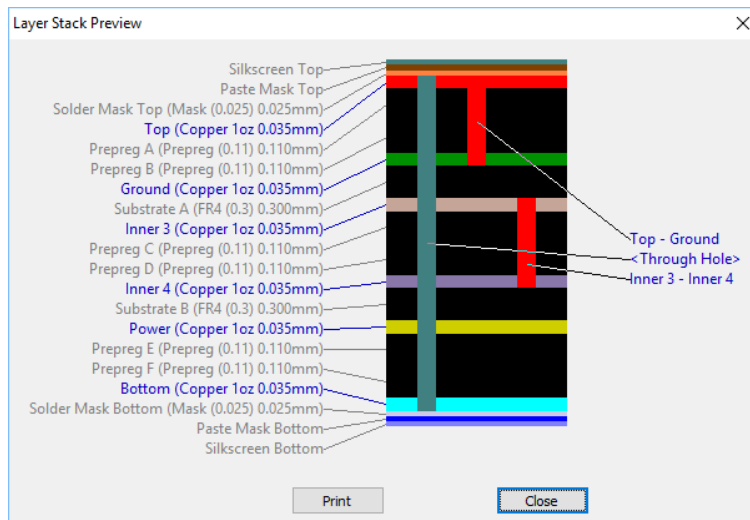

Use the **Print** button to print a copy of the **Layer Stack Preview**.

This can also be added to your design using the **Insert Layer Stack** option.

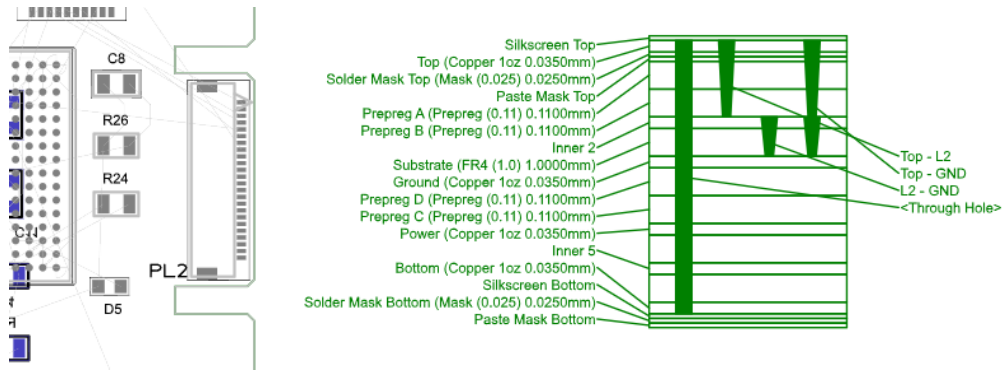

Changing the Colours in the PCB

All entities of the PCB design can have their colour changed. Each layer based item can have a different colour on each of the layers defined in the design. So, for example, you can differentiate between Copper on the top of the board from copper on the other side. Colours are accessed from the **Setup** menu **Technology** and **Colours**, or from **Setup** and **Colours**. They both go to the same location.

Layer	Displayed	Selectable	True Width	Colour
Assembly Top	<input checked="" type="checkbox"/>	<input checked="" type="checkbox"/>	<input checked="" type="checkbox"/>	Orange
Silkscreen Top	<input checked="" type="checkbox"/>	<input checked="" type="checkbox"/>	<input checked="" type="checkbox"/>	Dark Green
Paste Mask Top	<input checked="" type="checkbox"/>	<input checked="" type="checkbox"/>	<input checked="" type="checkbox"/>	Brown
Solder Mask Top	<input checked="" type="checkbox"/>	<input checked="" type="checkbox"/>	<input checked="" type="checkbox"/>	Light Green
Top	<input checked="" type="checkbox"/>	<input checked="" type="checkbox"/>	<input checked="" type="checkbox"/>	Red
Ground	<input checked="" type="checkbox"/>	<input checked="" type="checkbox"/>	<input checked="" type="checkbox"/>	Yellow
Power	<input checked="" type="checkbox"/>	<input checked="" type="checkbox"/>	<input checked="" type="checkbox"/>	Cyan
Bottom	<input checked="" type="checkbox"/>	<input checked="" type="checkbox"/>	<input checked="" type="checkbox"/>	Magenta
Solder Mask Bottom	<input checked="" type="checkbox"/>	<input checked="" type="checkbox"/>	<input checked="" type="checkbox"/>	Light Blue
Paste Mask Bottom	<input checked="" type="checkbox"/>	<input checked="" type="checkbox"/>	<input checked="" type="checkbox"/>	Blue
Silkscreen Bottom	<input checked="" type="checkbox"/>	<input checked="" type="checkbox"/>	<input checked="" type="checkbox"/>	Light Purple
Assembly Bottom	<input checked="" type="checkbox"/>	<input checked="" type="checkbox"/>	<input checked="" type="checkbox"/>	Dark Purple
Construction Lines	<input checked="" type="checkbox"/>	<input checked="" type="checkbox"/>	<input checked="" type="checkbox"/>	Grey
Population	<input checked="" type="checkbox"/>	<input checked="" type="checkbox"/>	<input checked="" type="checkbox"/>	Light Blue
Reference	<input checked="" type="checkbox"/>	<input checked="" type="checkbox"/>	<input checked="" type="checkbox"/>	Green
Profile	<input checked="" type="checkbox"/>	<input checked="" type="checkbox"/>	<input checked="" type="checkbox"/>	Brown
Documentation	<input checked="" type="checkbox"/>	<input checked="" type="checkbox"/>	<input checked="" type="checkbox"/>	Black

The PCB Colours dialog is been divided into two grids for **Layers** and **Multi-Layer Items** (such as pads) that appear on the **Top Side**, **Bottom Side** and **Through Board** layers.

Multi-Layer Items

Multi Layered Items	Displayed	Selectable	True Width	Colour
<Through Board>	<input checked="" type="checkbox"/>	<input checked="" type="checkbox"/>	<input checked="" type="checkbox"/>	Dark Green
<Top Side>	<input checked="" type="checkbox"/>	<input checked="" type="checkbox"/>	<input checked="" type="checkbox"/>	Red
<Bottom Side>	<input checked="" type="checkbox"/>	<input checked="" type="checkbox"/>	<input checked="" type="checkbox"/>	Cyan

The three special layers, that represent groups of layers; through the board (<Through Board>) and sides (<Top Side> and <Bottom Side>) are in a separate table at the bottom. These layers only become visible if one of the layers in the group it represents is also visible. For example, pads on the <Top Side> would be visible if the **Top** electrical layer were made visible and the <Top Side> were also visible. A special case for this is when all the layers in the top table are not visible, in which case you can view the special layers alone.

Translating from Schematics

An integrated element of the Pulsonix Schematic/PCB design environment is the option to translate the Schematic design to a PCB design without using a netlist or other commands. The **Translate to PCB** option is available on the **Tools** menu. When selected, you are presented with the following dialog:

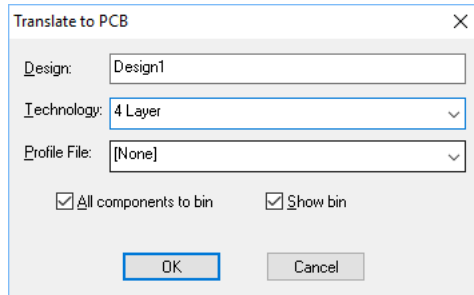

This dialog provides you with the option to name the design although a default name matching the Schematic design name is provided. If you decide to use this, it will make it easier later on when you come to use the **Synchronise Design** option, or **Cross Probing**, as both options by default use the corresponding Schematic design names.

The **Technology** box allows you to choose the **PCB Technology** file to use. The technology defines the layers, colours and other aspects of the 'make-up' of the overall PCB design, this includes power plane layers, pad styles, track styles, etc.

The Profile files box allows you to choose which **PCB Profile** file to use. This will give you a jump-start, because you can have your board outline and other general annotation predefined. You can also have critical components pre-placed in the profile. If the Schematic uses the same Parts, the critical components will be taken from the Profile.

Check the Unplaced components to Bin option if you want to use the **Component Bin**, otherwise components are stacked in the design area if no board outline exists, or around the board outline if one is available.

The **Show Bin** option is available if you have selected the option to place unplaced components into the bin, use this to display the Component bin automatically.

Once run, a new PCB design session will be started using a New PCB design containing a Technology file loaded (if selected), a Profile file loaded (if selected) and a netlist loaded containing all the nets and components from the Schematic. The components may be placed in the Component Bin or around the board profile outline depending on whether the **Unplaced components to Bin** check box was selected. If no Profile file was specified, and the Component Bin not used, the components and nets will appear in a 'stacked' column within the design area.

At this point the design is ready for Component Placement and Routing.

Importing a Netlist

Pulsonix can import many ASCII netlists from other systems in different formats if you decide to use a different CAE application to create your schematics or if your netlist source is external. You can use this mechanism to start your new PCB design. During import, it will expect a collated netlist with all duplicate Net and Component names resolved. It will check these on import anyway and reject the netlist if errors are found.

Use the **Import Design Data** option on the **File** menu. Select the format required using the **Files of Type:** drop down list box. Select the file to import and press the **Open** button.

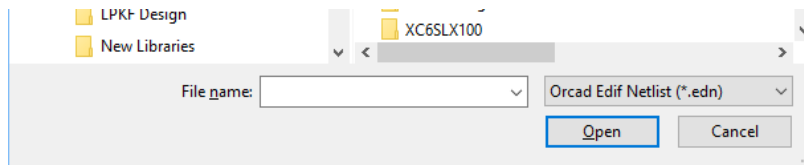

You can optionally choose to map the part names used in the other system to the part names that are used in Pulsonix.

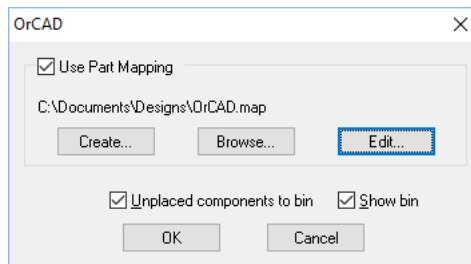

During the import, the Parts used in the netlist will be loaded from the existing Parts/Footprint libraries. If these Parts don't exist, an error will be displayed. All errors must be corrected to ensure 100% accuracy of the imported netlist.

If a Pulsonix Profile file has been used when creating the new PCB, you will need to either remove any components first before loading the netlist or use the **Import ECO option** after, to check the original netlist against the design and make any changes necessary to bring the two into line.

For details on importing netlists from other systems please refer to *Chapter 12* under the section **Importing Netlists into Pulsonix PCB**.

Creating a Board Outline

The board outline is an outline that defines the extents of the manufactured printed circuit board. There are two methods to create a board outline in Pulsonix. You can create a board outline on-the-fly using **Insert Board**, or you can load an existing board **Profile file**. You could also import and extract a board outline from another PCB system or create it from an imported DXF file or STEP file.

Insert Board

The **Insert Board** option is available from the **Insert** menu.

Insert Board allows you to interactively create a board outline by drawing it into the design. This mode allows you to add board outline using one of three shape styles provided: Rectangle, Circle and Polygon. Board outlines would normally be created using an **unfilled** shape that is **non-intersecting** and that has a **closed** start and end point. While adding these shapes they can be carefully added to create the exact shape, or edited in more detail after being added.

Board outlines are not layer based items, therefore they appear on all layers as <Through Board>.

If creating designs that use multiple board outlines, e.g. flexible circuits, these can be added to the design but you cannot add additional board outlines to act as cutouts. If you require cutouts, use the **Insert Cutout** option to add 'real' cutouts within the board outline.

The **Board** outline default shape is taken from the **Design Settings** dialog and **Defaults** page. The Line style used is defined in the **Technology** dialog under **Line Styles**.

For more complex shapes, use the Construction Line feature. This provides advanced drawing capabilities from which you can then create the board outline.

► To insert a board outline

1. On the **Insert** menu, click **Board shape**.
By default, the **Board Polygon** shape is available on the PCB toolbar as pure rectangles or circles are rarely used.
2. Click to start the first corner. Move the mouse to create the first segment of the outline. By moving the mouse you will notice that orthogonal segments are added, one horizontal, one vertical but moving together in synchronisation with each other and stretching dynamically. By clicking the mouse you will insert corners into the outline.
3. On each subsequent cursor move and click, more corners will be added to create a polygon shape. The length of each segment can be seen on the status bar at the bottom of the Pulsonix window (dx and dy). An example polygon might look like this:

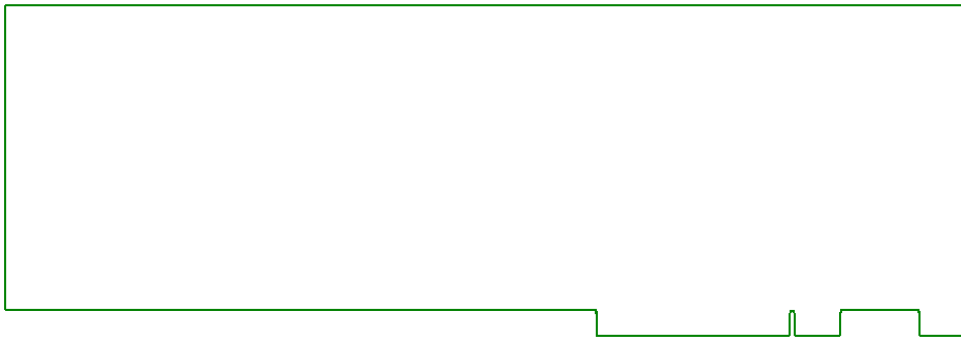

4. Double-click the mouse to finish the polygon. If during the insert, you decide that you wish to cancel, press the <Esc> key on the keyboard.

During the creation of the board outline, clicking the right mouse button you can open a context menu. This has additional commands applicable to this mode of operation. For example, **Curved** corners and **Angled** segments through the **Editing Options**, as well as line style and grids.

From the context menu for a selected board outline, you can also choose to **Type** the **Coordinates** and/or **Type** the **Offset** of the shape being added.

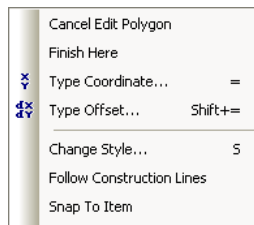

It is recommended that you create the board outline away from the edge of the design area and starting on a grid point to make it easier to edit later on.

Importing DXF and STEP Files

Both **DXF** and **STEP** mechanical CAD files can be imported through the **Import Designs** option on the **File** menu. This is explained further in Chapter 9.

Using the Shape Information Bar

The **Shape Information Bar** (previously described) can also be used to create and edit board outline shapes. This will enable complex shapes to be created using coordinates or lengths.

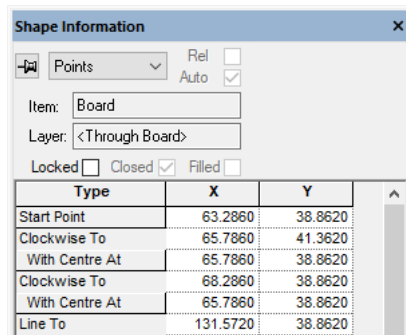

Insert Mounting Holes

Mounting holes are used to support the board within an enclosure or other mounting device. Mounting holes can also be included in the Footprint library used for mounting components when used on the PCB.

Insert Mounting Hole is used to insert a mounting-hole pad into the design from the range of pad styles defined in the **Technology** file under **Pad Styles**. The mounting hole may have a net name connection in exactly the same way as any other type of pad in the design.



Though there are similarities in the way pads and mounting holes are regarded by the system there are some important differences:

Mounting holes do not appear in the pad count when creating footprints and do not appear in the overall pad count when creating Parts. They must be added using **Insert Mounting Hole** for this rule to be active.

They are regarded as unnamed pads that do not appear on the Parts List output. If you need them in the Parts list you should create the equivalent Part.

The system recognises that the drill hole size in the mounting hole may need to remove the whole copper area of the pad, hence You will warned of this when creating the **Pad Style** used.

Like 'normal' pads, mounting holes can be defined on the Top, Bottom or Through Board layers. The layer can be changed while adding them or afterwards.

The mounting hole is recognised as such by the system and has its own **Spacing Rules** defined in the **Technology** under **Spacing Rules**

During the **Insert Mounting Hole** operation, the default pad style selected is defined in the **Design Options** dialog and **Defaults**.

► To insert a mounting hole

1. Click on the **Insert** menu, click **Insert Mounting Hole**
2. The default Mounting Hole shape as defined in **Design Settings, Defaults** will then be visible, positioned at the end of the cursor. You may then place the Mounting Hole at the required position in the design. Click the mouse to complete the Mounting Hole positioning operation.

► To change the mounting hole pad style

1. Select the mounting hole pad and right click.
2. From the context menu, select either **Change Styles** or **Item Properties**. The styles available have been defined in the **Technologies** dialog under **Pads**. From the context menu you can also add new styles.

Mounting Holes and the Schematic Design

Mounting Holes can be defined in your Schematics and attached to a Net if required. This is then passed into the PCB during Translate to PCB as a PCB Doc Symbol.

Using Profile Files

Board Profiles are stand-alone design files that contain data describing standard board types that you can use as a starting point when designing a PCB board of that type. They can be used as an alternative method to using the Insert Board Outline option.

Profile Files can contain the Board Outline that has the shape and size required for manufacturing as well as documentation (Text) and annotation required (Dimensions and Shapes). They can also contain Mounting Holes, components (such as standard connectors along the edge of the board) and Documentation Symbols. Origins, Copper, Pouring Templates, Areas and Attributes can also be included in Profile Files to make them as ready as possible to start a new design.

Board profiles can be designed in Pulsonix or extracted from a design previously converted from another system. Once in Pulsonix PCB the board profile information can be saved as a Profile design file in its own right.

Even if a PCB design is completely finished, the profile data within it can be extracted into its own file using the **Save Profile** option on the **Setup** menu.

Pulsonix is extremely flexible in that it can save and load individual entities of a design, even when the design has originated in another design system.

There are examples of predefined industry standard board profiles for you to use, these can be located in the **Pulsonix\Profiles** folder by default.

Loading Profile Files

The **Load Profile** option allows you to load an existing board outline as well as other design based information, such as a page border or assembly/mechanical information. These files can also be used along with **Technology files** as your starting point when using the **New PCB Design** option.

► To load a profile file

1. On the **Setup** menu, click **Load Profile**. You are presented with a dialog containing a drop down list from where to make a choice of profile files.

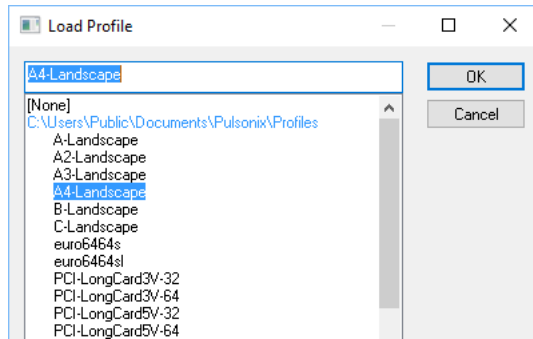

2. Select the file required from the list and click **OK**.
3. For other profiles that may be located outside the immediate search path defined in the **Folders, Profile Files** path, you will need to add the Profile File location to the list of search paths in order to be able to load them.

The Profile will be added to the design but remains selected for repositioning. Click in free space to deselect it. If you wish to move it, select the outline and drag it to the new location. The picture below shows one of the supplied Profile files.

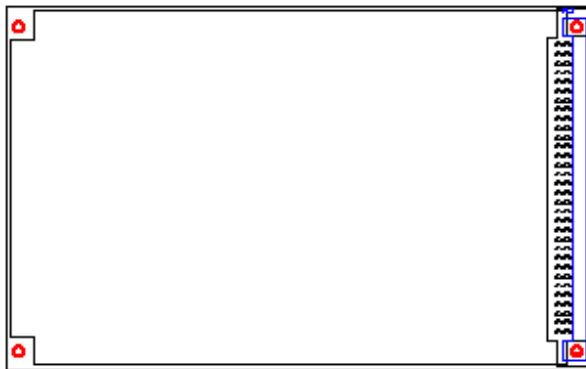

Any Technology file items that are used within the Profile file are automatically resolved during the insertion into the design. Style items that match existing styles in the design are mapped to the existing style. Styles of the same name but different contents are added using a new style name.

Once created Profile files can be added to the design like most other items. These can be added at any time during the design process but it does make more sense to add them early on to give you a guide to the size of the board and the area you have to work in.

A range of standard Profile files is supplied as part of the Pulsonix installation.

Component Pre-placement in PCB

When Loading Profile files as part of the **Translate to PCB** mechanism and when using the **Load Profile file** option from the **Setup** menu, if the Profile file contains any pre-placed components (connectors for example) then the following happens:

- If the Schematic or Profile file contain a Component of the same Part as that used in the PCB design, the Component placed in the Profile file will be used.
- Component names used in the Profile file will be changed to match the ones used in the Schematics. Any components in the Profile that do not match components in the Schematics will be discarded.

Loading a Page Border

Page borders can be loaded using the **Load Profile** option. Alternatively, you can use a Documentation Symbol or create a border interactively using the **Insert Shape** option.

Setting the Design Origin

The design origin is called the **Coordinate System Origin** in Pulsonix. By default this is located at an absolute co-ordinate of 0,0 or the bottom left hand corner of the working area.

The origin can be changed at any time using the **Design Settings** option and **Coordinate System** tab.

Coordinate System Origin:
 (Offset from the lower left corner of the design area)

The **Coordinate System** and **Relative Origins** can both be changed using the appropriate options on the context menu of a selected item, i.e. a Pad. The **Set Symbol Origin** and **Set Relative Origin** commands are located on the **Select>** sub context-menu for a selected item.

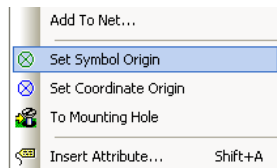

It is better, and more consistent to change it at the start of the design process. The process to change the design origin has been discussed in Chapter 5, *Setting Up The Design*.

Inserting Components

One of the first processes to attempt once the Technology file and Profile files have been loaded is the insertion of components into the design. Pulsonix provides the **Insert Component** function for this purpose. This process would only be used if a Pulsonix Schematic or netlist from another system has not already been loaded.

You can also use the **Part Browser** or **Parts toolbar** options to load Parts, these have been discussed in a previous chapter.

Part and Footprint contents are created and saved into corresponding libraries. The Part entry must contain a Part name, a Footprint and a corresponding Schematic Symbol or multiple symbols if the Part represents a multi-gate Component. In PCB, an instance of a Part used in the design is called a Component.

The actual creation of Parts will be covered later on in the manual in the Chapter on *Library Management*.

Using the Insert Component dialog

Insert Component is a dialog driven option that allows you to select the required part from the appropriate library.

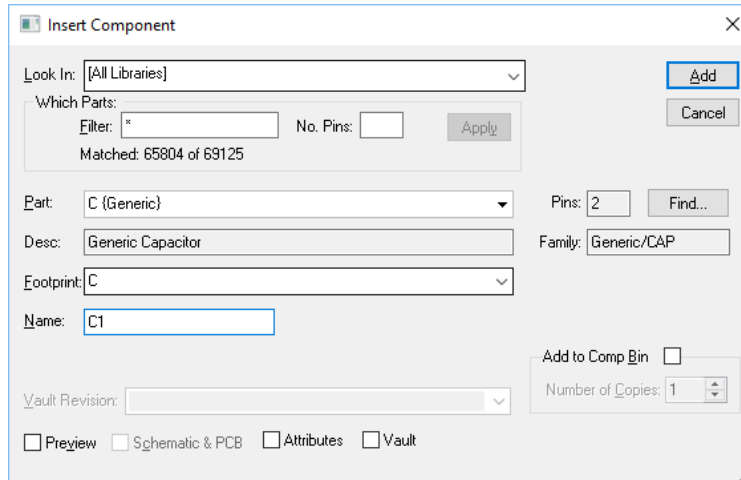

Use **Look In** to choose the libraries you are going to search for the required Part. Normally **[All Libraries]** will be used to search all libraries in the Library folder, otherwise, select the library name or use **[Current Design]** to search components in the design. All other libraries available in the drop down list will be shown using their own name.

Which Parts enables you to filter the search list to find specific Parts. The Filter box can take any name and wildcard characters. Use the **Apply** box to use any filter wildcards entered.

*Wildcards can be used to make the filter more efficient. (Wildcards are special characters that are used to match any character rather than being specific, for example * and ?). For example, 74HC* More information about using Wildcards can be found in the on-line help.*

The **Pins** box is used to limit the matching parts to those with a known number of pins (blank means any pin count but you can also use * for any).

Once a Part or range of Parts matching the Filter selection have been found, the first Part available will be shown in the **Part** list. This will display the full Part name (74HC00) and the Library from where it came, shown in braces, e.g. {74}.

From the Part library entry, the available alternative **Footprint** entries will be loaded into the Part drop down list, e.g. DIP14. These may be surface mounted options or different packages available for the Part. Choose the required Part and Footprint.

The **Name** box shows the default name stem for this Part (taken from the Parts library default Component Name Stem entry) and the next available number in the sequence. Both the name stem and the number can be edited if required.

The **Symbol** box lists the symbols that can be used to represent the component or gate in the schematic design. If an alternative to the default is required, select it from the dropdown list. If the part has multiple gates the symbol selection applies to the currently selected (and highlighted) gate.

The **Component Bin** check box can be selected if you wish to add the Component(s) to the Component Bin. These components can then be dragged from the Bin into the design at a later stage. The **Number Of Copies** box allows you to add multiple parts to the Bin in one operation. Please refer to the section later on *Using The Component Bin* for more information.

The **Preview** check box opens the preview window allows you to view the Component before it is inserted into the design, this gives you chance to visually inspect it to ensure that it is the current one.

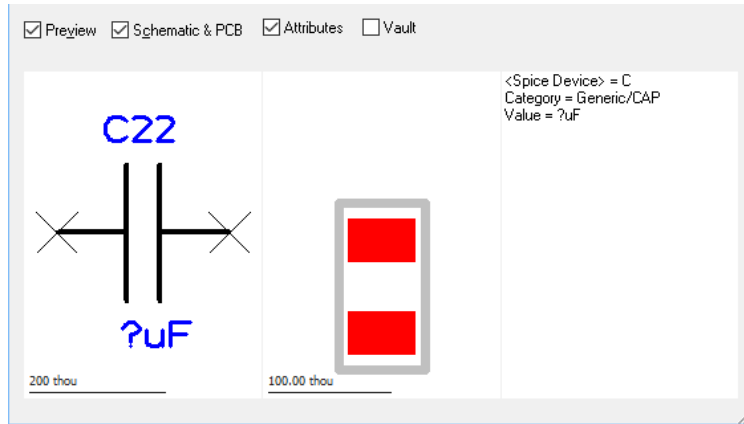

Once you have the Part you require (shown in the Preview window) and its Footprint and Name are correct, you can add it to the design using the **Add** button.

If not adding components to the Component Bin, the **Add** button will dismiss the dialog from view and will allow you to add as many Parts of the type selected as you like to the design. If you require a **different Part** you should cancel this process by pressing the **<Esc>** key on the keyboard. This will immediately return you to the Insert Component dialog from where you can make further Part selections. If you wish to **cancel Insert Component** completely, having finished this process, you can select any option button from any Toolbar and Insert Component will be immediately cancelled. If already in the Insert Component and you wish to exit, you can again select **<Esc>** from the keyboard or use the **Cancel** button from the dialog. You can also exit the Insert Component mode by clicking the **Select** button on the toolbar (the Select button is the small 'Windows' arrow button).

Interactively positioning a Component

Whilst using the mouse to position the Component, you can use the context menu to change its angle and to mirror it, for example. This is explained in detail in the Chapter *General Utilities* under *Moving Items* and more specifically for PCB components later on in this Chapter.

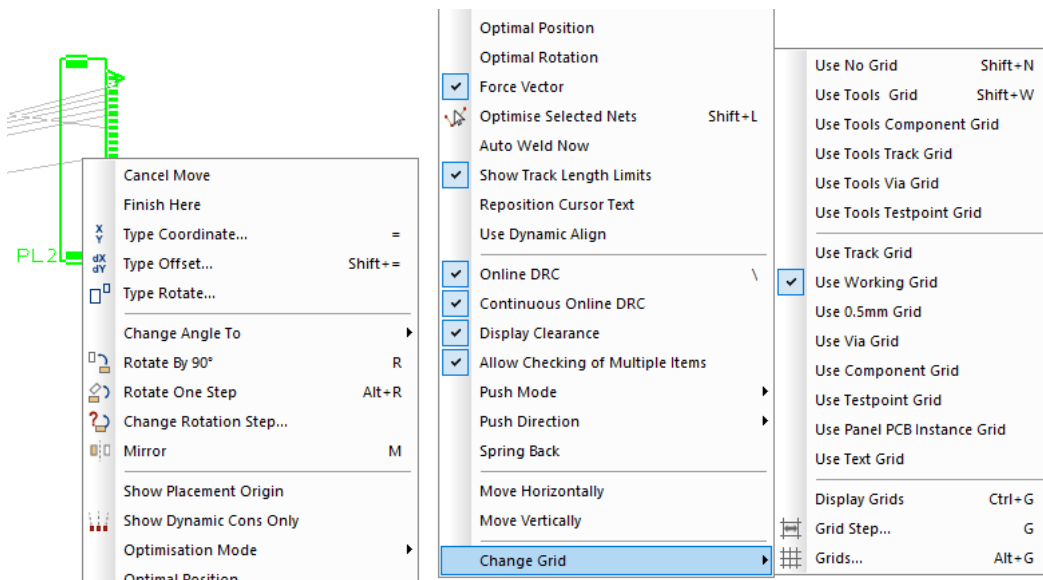

Once in the design, components can be positioned to their required location using the **Move** option or by selecting and dragging them.

Further detail of moving components and the options available is discussed later on in this section.

Reloading Parts

Once components have been loaded into the design, you may need to change the Footprint or the Part definition and reload it.

You should select the Component you wish to edit. From the context menu you are provided with options to **Reload From Library** (once the Part and/or Footprint has been edited), **Edit Part In Library** and **Edit Footprint In Library** to edit the actual Part or Footprint items.

If you select one of the two **Edit** options, you will be automatically placed into the Part or Footprint editor with that particular Part or Footprint loaded ready for editing and saving. You should make your changes and save the updated library item. This is detailed later on in the Chapter on **Library Management**.

Once the Part and/or Footprint item has been changed, you need to then reload it back into the design, effectively 'swapping' out the existing item for the new one.

To do this, use the **Reload From Library** option. With the Component selected in the design, you can use the option from the context menu, or the **Reload From Library** options on the **Utilities** menu.

Note: All other components using the changed Part or Footprint will also be reloaded. You cannot have two different versions of the same Part or Footprint in a design.

Performing the Reload

When the reload process is started, if you did not use the **Browse** method of starting it you will be presented with a confirmation dialog:

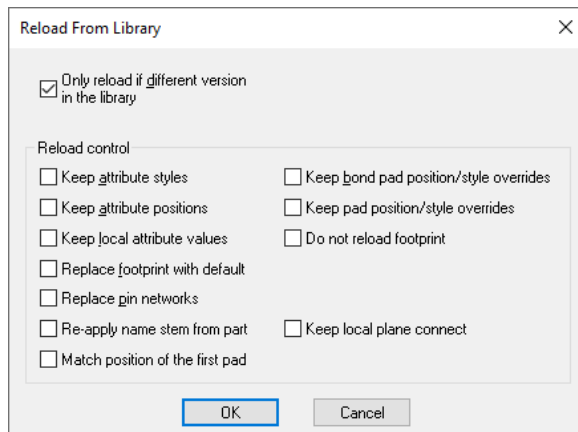

Check the '**Only reload if different version in the library**' box if this is required. Leave it unchecked if **ALL** chosen items are to be updated even if their version is the same as in the library.

The system will then analyse the design and work out what items will be updated. When this is complete you will be presented with a summary dialog in order to decide whether to go ahead with the update, or just produce a report at this stage.

You are prompted with a summary page detailing the status of the Parts and Symbols within the design or the selection.

Reload From Library - Summary

Reloading single part or symbol.

Selected for reload:

1	Part
0	Associated Parts
1	Symbol
0	Doc Symbols

Selected items to be reloaded:

0	Parts
0	Associated Parts
1	Symbol
0	Doc Symbols

Additional symbols to be reloaded:

0	Symbols
---	---------

Selected items NOT to be reloaded:
(Same version as library)

1	Part
0	Associated Parts
0	Symbols
0	Doc Symbols

Include Component Names In Report

From this you can view the report (**View Report**) of the changes to make, and then once satisfied with the proposed changes, can **Perform Reload** to actually make the changes.

If using the **Reload From Library** option from the **Utilities** menu, you can **Browse** the Parts, Symbols and Documentation Symbols to change.

Reload From Library/Vault

Parts:

- HCPL-3150#300
- HCPL-315J

Associated Parts:

Footprints:

- S08GW350
- S0J16-370-12

Documentation Symbols:

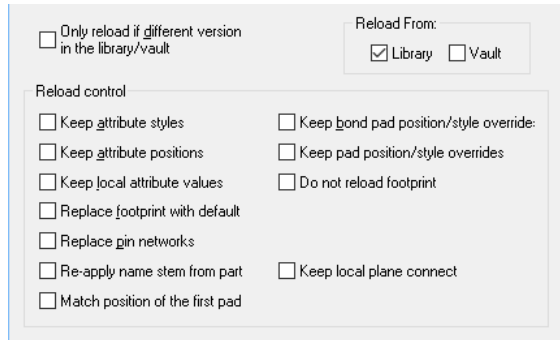

This dialog allows you to make a more refined selection based on the name of the library item rather than its selection or a general 'reload all' option.

By using the **Reload All** option, and '**Only reload if different version in the library**' switch, you can use the **View Report** button to get a report of the library items used in the design have been updated in the libraries since you created the design.

Press **Perform Reload** to carry on with the reloading. If you had errors detailed in the summary dialog, but did not notice you will be presented with a warning. Press **Yes** to perform the reload on the parts and symbols that can be found in the libraries. Press **No** to abort at this stage.

Connected Components

If your Component were connected, it would normally be reloaded with a component with the same number of pins in order to not affect the nets. The connections or tracks will be attached to the pads with the matching pin name in the new part.

If you reload a part with more pads, the extra pads will remain unconnected in the design. If you reload a part with less pads than on the component, any connection to a pad that does not exist on the new part will be removed, and any track in the same situation will be disconnected and left dangling for you to sort out in the design later.

For schematic components, as well as pins being matched up, gates are matched so that if you reload a four gate Component with a single gate Part, only pins on the first gate of the original component will retain their connectivity. All connections to pins on unmatched gates will be disconnected and left for you to sort out later.

Using the Component Bin

This section details how the Component Bin is used in the PCB design editor. An overview on how the Component Bin works generally can be found in the Chapter *Using Pulsonix*.

The Component Bin in PCB is used for holding unplaced components to free up the design area while placing other components. This makes the design area less cluttered, especially on dense complex designs.

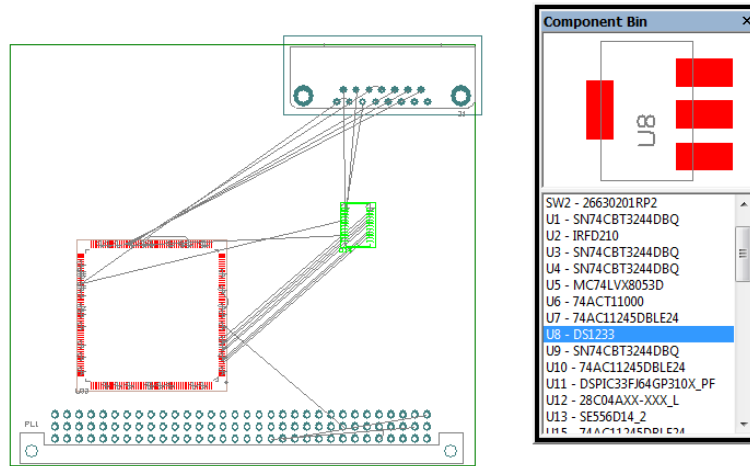

Moving Components to/from the Bin

Components can be moved to the Bin using a number of methods:

- By dragging the Component to the Bin from the design
- By using the right mouse button and the Move To Bin option
- From the Insert Component option
- From within the Auto Place option using Move To Comp Bin
- By using the Translate to PCB option within Schematics

Dragging Components to the Bin from the design

The most practical method of placing components into the Bin is by clicking and dragging the components from the design. Multiple components may be selected and dragged into the Bin also.

If the Component is connected with connections only, the connections remain in-tact when the Component is moved into the Bin but are not displayed until the Component is brought back into the design. Electrical connectivity and total design integrity are maintained at all times (even though the connections may not be displayed). This principle is for PCB only, the Component Bin Schematics editor works differently.

If tracks exist to a Component, a warning dialog is displayed if a Component move is attempted to the Bin. You can at this point select to discard all tracks to the Component by clicking **Yes**, or returning to the design by clicking **No** or **Cancel**.

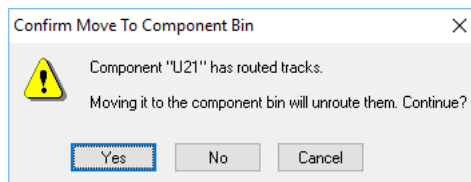

If you click **Yes**, when the Component is replaced into the design the tracks are not rebuilt, and the Component remains unrouted. At this point only **Undo** can restore the tracks if you've made a mistake, provided you have enough Undo levels set to get back to the point where the Component was routed!

During the move of components to the Component Bin, if components are locked, a warning dialog will be displayed.

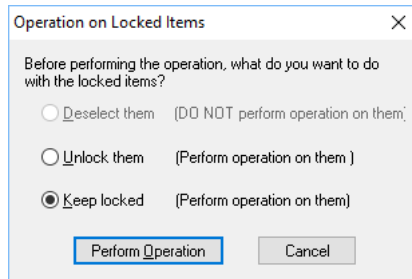

This provides you the opportunity to confirm the move of the components but is an additional safety feature for critical components that may have been deliberately locked.

From the context menu

Another method of moving components to the Bin is by selecting the components and right clicking. On the context menu, from the **Components/Symbols** sub menu, the **Move To Bin** option will allow you to directly move any selected components to the Component Bin.

This context menu option is also available if a frame select has been executed, even if it includes alien objects such as board outline, copper or free text etc.

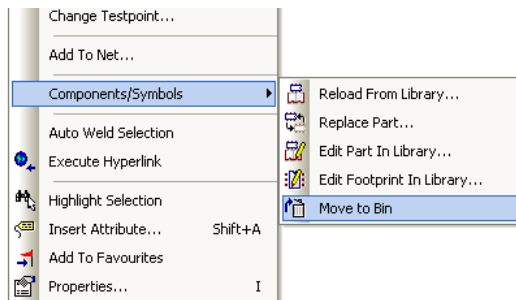

Again, the same rules apply for routed components losing their tracking information when placed in the Bin as before.

From Insert Component

Insert Component provides a check box and **Number Of Copies** entry to send components directly to the Bin ready for placement.

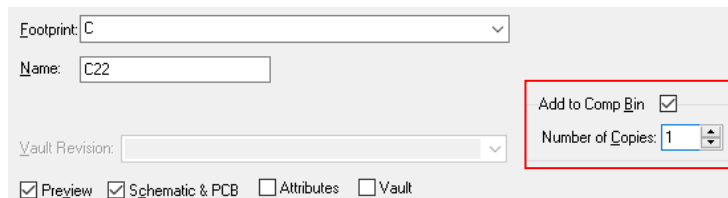

From Auto Place

Another quick method for moving all components from the design to the Component Bin is to use the **Auto Place** option located on the **Tools** menu. Within this dialog is a selection to move the

components to **Component Bin**. By selecting this, all unlocked components in the design will be moved to the Bin.

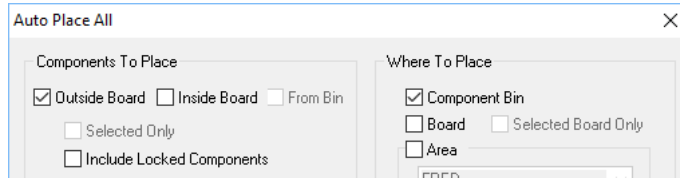

From Translate to PCB option within Schematics

Within the **Translate To PCB** option in the Schematics editor, you have the option to send all **Unplaced Components to Bin** during the translation process.

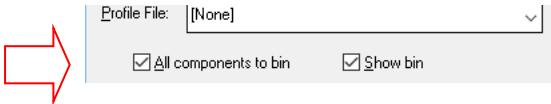

Moving Components from the Bin

Components can be moved from the Bin using a number of methods:

- By dragging the components out of the Bin into the design
- By using the right mouse button and the Move From Bin option
- By using the Auto Place option

Dragging Components from the Bin

The Component Bin is designed to be an interactive tool for fast 'drag & drop' usage. To place components in the design from the Component Bin, you select the Component required in the **Bin** or in the **Preview** window, and drag it into the design.

Note: during move the drag may be cancelled by dropping the Component back into the Bin, by pressing the <Esc> key, or once released, by using Undo (Ctrl-Z).

Once in the design the Component can be moved until released.

Using Move From Bin from the context menu

From within the design and with nothing selected (and outside the Component Bin), if you right click, the option **Move From Bin** is available.

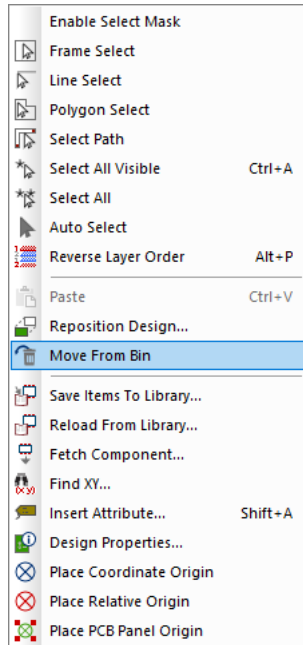

This will move the currently selected Component in the Bin into the design ready for positioning. Once the Component has been released, the next Component available in the Bin will be moved into the design ready for positioning.

Placing Components around the Board Outline

To aid placement, there are a number of placement options that Pulsonix provides. Each option will depend on the designers' own preference and design practices but Pulsonix is flexible enough to allow any of them to be used when required. You have **Place Around Board**, **Auto Place**, **Place From Component Bin** and **Manual Place**.

Following a the **Translate To PCB** process, if the components are not sent to the Component Bin and no board outline exists or a Profile file has not been specified, the components will be placed in an orderly row in the design area (away from the 0,0 origin). If a board outline exists or a Profile file specified, **Place Around Board** is automatically used.

As it suggests, the **Place Around Board** facility is used for fast placement of components around the outside of an existing board outline. This placement methodology is an alternative to the 'stacking' method and is often preferred by designers. The **Component Bin** placement facility is another alternative and will be generally preferred overall for users manually placing designs.

The **Place Around Board** option is used when you require the components to be 'stacked' close to the working area and around the board outline ready for manual placement.

When run, it places the components, grouped by Part Name, spiralling around the board outline. If there are many components in the design and the board outline is too small, the spiral will continue again around the board continuously until all the components have been placed.

Components that are already routed or locked will not be placed.

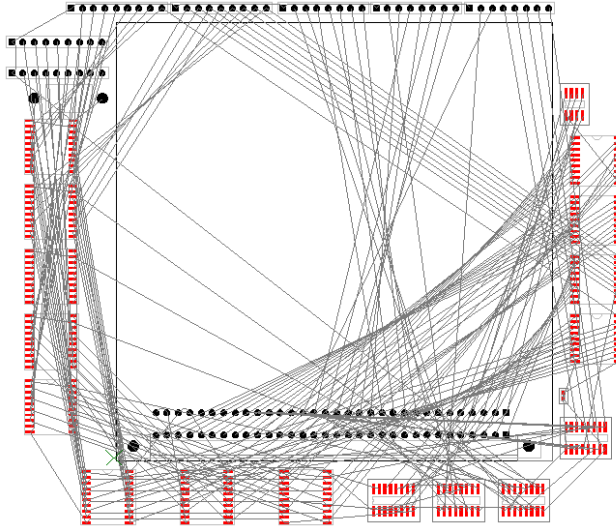

► To place around the board outline

1. From the **Tools** menu, click **Place Around Board**
2. The components will be placed around the board outline.

You may need to press the <A> key (**Frame All**) to see the whole design after placement but you will notice that the components have been stacked around the board outline. This feature uses the Part name for its selection criteria, stacking components of the same Part name in columns around the board outline.

On-line Design Rules Checking (DRC)

Pulsonix supports On-line design rules checking (On-line DRC) for use during any interactive activities, such as Manual Placement, Manual Routing, Insert Text, Move etc. Each of these options will be discussed throughout this chapter of the manual, where the On-line DRC process will also be detailed.

With the checking enabled, all interactive modes will be continuously checked to the **Spacing Rules** defined in the **Technology Spacing Rules** dialog. See previously in this chapter for more details.

From the **Options** dialog and **Online DRC** page, if the **On-line DRC** box is checked, some level of design rule checking will be performed during manual editing of the items in the design. The depth of this checking is determined by the following options:

Online DRC

Checking

Continuous (Avoids errors during some interactive operations)

On Drop (Check changed data after interactive operations)

Check Attached Tracks & Wires On Drop

After Edit (Check item after having its properties edited)

Add Error Marker (to show first error)

Continuous

Check Poured Copper

On Drop Only

Check Via In Pad

Check Comp To Comp

Check Same Net Via To SMD

Show Design Rule Clearance

On All Items

Refine Within Distance

Within Set Distance:

Within Grid Steps:

Show Clearance On Breakouts

Allow Checking of Multiple Items

Continuous is used to automatically avoid creating design rule errors during some interactive operations. Generally it is used if the operation involves editing a single item on an electrical layer. For example, whilst adding a track it will not be able to cross other items on the same electrical layer. Moving a Via will not allow you to place it on top of any tracks on layers it spans. A Component is regarded as too complex to use continuous checking on as it would be too slow to check every layer for 'Through hole' pad violations on the fly.

On Drop is used to automatically check the changed items in the design after any interactive operation. If an error is found, you will be asked if the error is allowed, or if the operation should be reversed.

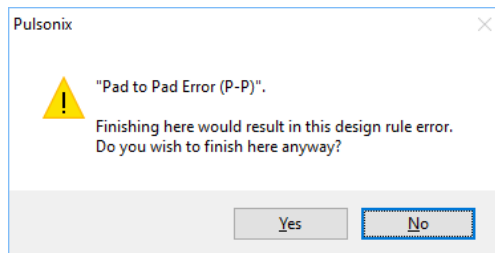

For example, if you drop a Component on top of another (during Move) you are warned of a **Pad to Pad** error. You may then leave the Component in error, or carry on moving it to find a legal location.

The **Check Attached Tracks On Drop** option is used when moving or rotating a Component that has dynamic tracks attached, it is difficult to drop the Component in a location where the tracks do not violate other design items. Generally, these tracks would be tidied up at a later stage. Uncheck this box to avoid getting errors reported for these tracks.

After Edit is used to automatically check the changed items after editing when using **Item Properties**. If, when applying the changes in a Properties dialog, an error would occur you will be

asked to confirm if the error is allowed. If not, the changes are not applied and you are returned to the Properties dialog to amend the change.

If using **On Drop** or **After Edit** and you wish to continue even though the change will result in an error, use the **Add Error Marker** switch to automatically insert an error marker into the design. This is a visual reminder of the error so that you can fix it at a later stage.

Show Design Rule Clearances

To aid the On-line DRC mechanism, from the **Options** and **Online DRC** page, there is also the **Show Design Rule Clearance** option that is used to automatically display the clearance around static items during some interactive operations.

Generally, it is used if the operation involves editing a simple single item on an electrical layer. The clearance shown is set to the size of the allowed spacing between the static item and the item being interactively edited. This clearance shows how close the item can be placed to another without violating it. As the dynamic item moves within the allowed clearance gap, the clearance will change colour to indicate that the moving items is in error.

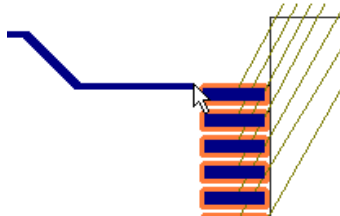

When checked, there are three modes of operation available; **On All Items**, **Within Set Distance** and **With Grid Steps**.

With **On All Items** selected, as you start the interactive operation, all the electrical items that are visible on the same layer as the item being edited will have the clearance drawn around them. This will be cleared when the operation has finished.

Within Set Distance set, when the item being edited comes within the entered distance of another static item on the same electrical layer, the static item will have its clearance drawn around it to warn you that you are getting close. The clearance will disappear as you move away from the static item again.

Within Grid Steps set, when the item being edited comes within the entered number of grid steps of another static item on the same electrical layer, the static item will have its clearance drawn around it to warn you that you are getting close. The clearance will disappear as you move away from the static item again.

This mode can also be switched on or off from the context menu during some interactive operations. On the context menu, this option is shown as **Display Clearance**.

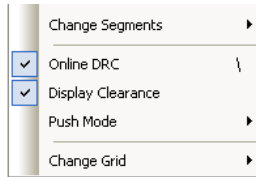

The **Clearances** colour can be set up in the **Colours** dialog on the **Highlights** tab. You should choose a contrast colour to make it visible against other design items.

Name	Displayed	Colour
Attached Dimensions/Callouts	<input type="checkbox"/>	
Branch Point Via	<input type="checkbox"/>	Blue
Bus Tracks	<input type="checkbox"/>	Green
Clearances	<input type="checkbox"/>	Orange
Component Pad 1	<input type="checkbox"/>	Grey
Differential Pair Path	<input type="checkbox"/>	Yellow
Differential Paired Tracks	<input checked="" type="checkbox"/>	Brown
Highlight	<input type="checkbox"/>	Red
Highlight 'Fail'	<input type="checkbox"/>	Green
Highlight 'Pass'	<input type="checkbox"/>	Dark Green
Highlight 'Unchecked'	<input type="checkbox"/>	Light Green
Highlight 'Warning'	<input type="checkbox"/>	Orange
Locked Track Segments	<input type="checkbox"/>	Yellow
Marked Net	<input type="checkbox"/>	Blue
Not Fitted	<input checked="" type="checkbox"/>	Grey
Online DRC	<input type="checkbox"/>	Pink
Selection	<input type="checkbox"/>	Cyan
Signal Paths	<input type="checkbox"/>	Blue
Star Point	<input type="checkbox"/>	Green
Sub Nets	<input type="checkbox"/>	Light Green
Test Points (All)	<input checked="" type="checkbox"/>	Yellow
Test Points (Top)	<input checked="" type="checkbox"/>	Red
Test Points (Bottom)	<input checked="" type="checkbox"/>	Green
Unconnected Pads	<input type="checkbox"/>	Grey
Unfinished	<input type="checkbox"/>	Pink
Variants	<input checked="" type="checkbox"/>	Brown
Weld Spot	<input type="checkbox"/>	Green
Weld Spot (Direct Hit)	<input type="checkbox"/>	Light Green

Placing Components interactively

There are many advanced features within Pulsonix for placing components in the design. However, the basic operation of moving components is very straight forward following basic Microsoft standards.

The Component Move mode is activated by using the **Move** option or by **dragging** the Component (using a **pick and drag** action). When any Component is placed in the design, from Insert Component or out of the Component Bin for example, it remains 'dynamic' on the end of the cursor ready for placement.

Individual components or groups of selected components can be moved at any time. Using this method, anything else selected by mistake will also be included in the move as part of this transient group.

Overview of Component placement options

During Component Move you have a number of features available, you can:

- Rotate and Mirror a Component
- Optimise connections that are attached to the Component during Move

- Show the optimal position of the Component using a ‘Force Vector’
- Free dynamic tracks segments attached to the Component to make the placement clearer
- Push other components out of the way, and Spring other components back to their original positions Place or Rotate the Component in its Optimal position
- Change the Placement Grid of the Component

As part of the Component interaction, you also have facilities that can be accessed during the selection of a Component, these are in addition to the options available during Component Move:

- Cut, Copy, Paste, Delete and Duplicated the selection
- Enable the Move mode
- Optimise nets attached to the selected Component
- Lock or Unlock the Component
- Unroute tracks attached to the Component
- Automatically route nets attached to the Component
- Edit the Component in the Footprint or Parts library
- Reload any changed components
- Move selected components to the Component Bin

Setting up the options

Most of the options available during Move can be pre-defined ready for use using the **Move** tab on the **Options** dialog. You can also access all of these options from the context menu when moving a Component.

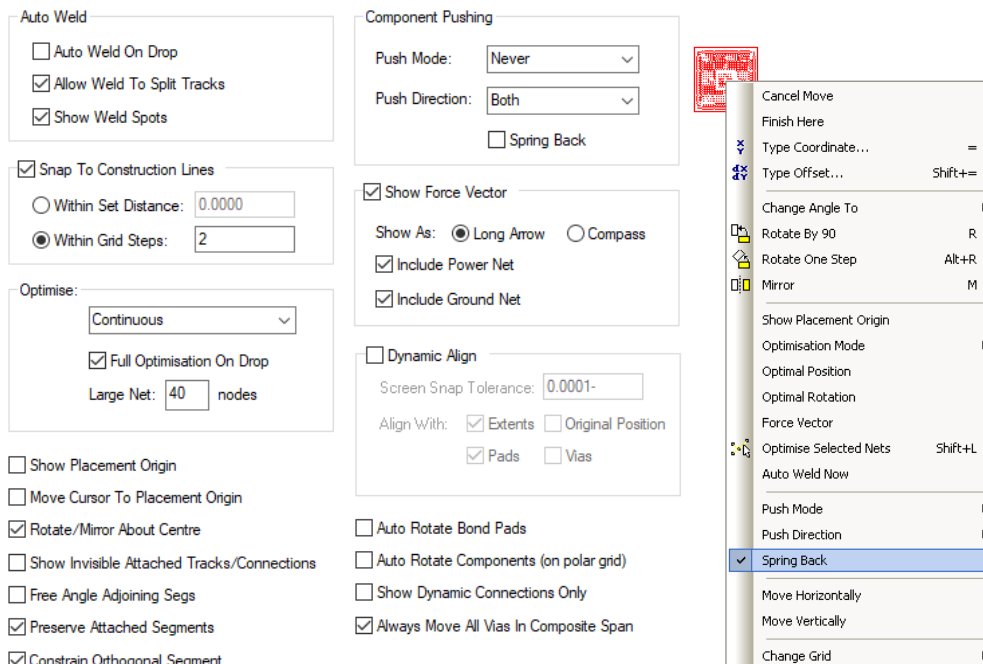

Options available on the context menu

There are modes of operation that can only be accessed from the context menu.

Change Angle To> - Select from the list of angles, 90, 180 and 270 degrees.

Rotate by 90 - This is a manual rotate feature using a 90-degree step. If you wish to use the **Rotation Step** defined in the **Options** dialog on the **Interaction** tab, use the shortcut key <Alt-R>. Rotation steps are always defined and implemented Anti-clockwise (counter-clockwise).

Mirror - Mirror will flip the selected Component(s) to the other side of the board. This will mirror all the pad positions and any associated text e.g. Component name U1 etc. and silkscreen outlines automatically. All pad stacks are automatically mirrored as well, although with SMT devices pads will only be defined on the top or bottom electrical layers anyway and will mirror to the opposite side.

Optimisation Mode (Connections) - When moving items that are on nets, the dynamic items are connected to stationary items. Where these connections are not tracks, unrouted connections are drawn from the moving items to the static ones. You have the choice of how these unrouted connections behave using the **Optimise** parameter as follows:

Continuous - The nets attached to the moving items are continuously optimised dynamically **on-the-fly** to show the minimum unrouted connections required to connect to the moving item at its current position.

Never - The unrouted connections are not optimised. They stay connected to the same stationary item that they were originally connected to.

On Drop - The unrouted connections are not altered whilst dynamic, but as soon as you release the Component into its new position, all nets attached to the moving items are optimised.

Whilst moving items on nets, you can right click the mouse to use the context menu options **Optimal Position** and **Optimal Rotation** to take the items to the position pointed to by the force vector.

Optimal Position

By selecting this option, the Component selected will move to the position the system calculates as the optimal placement. This is the most balanced point in the design relative to its attached connection length and the number of connections attached to its pins.

Optional Rotation - Like the Optimal Position option, the Optimal Rotation option will determine the best rotation based on a balanced assessment of the Component, its attached connection lengths and number of attached connections. The mirror axis is taken around the Footprint origin.

Force Vector - The force vector is a visible indicator that shows you how far, and the direction to move the dynamic items to their '**optimal**' position.

This position is where the nets attached to the moving items would be balanced to reduce overall connection length and avoid very long and very short connections. In other words to place the items where they are not too close nor too far from other stationary items on the same nets. If you consider the connections from the moving items to the stationary ones as springs, the optimal position is where the moving items would come to rest if you 'let go'.

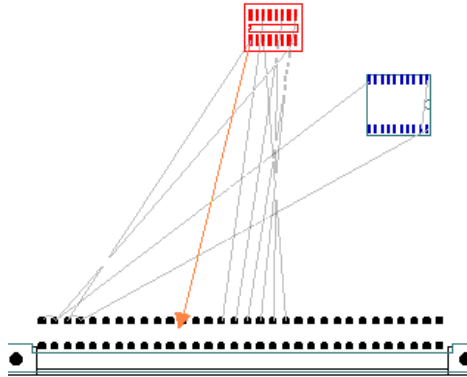

The force vector is drawn using the **Highlight** colour defined in the **Colours** dialog on the **Highlight** tab. There are two types of indicator available as follows:

Long Arrow - An arrow is drawn from the centre of the moving items to the optimal position.

Compass - A circle is drawn centred on the moving items with a small arrow on it pointing towards the optimal position. Another filled circle is drawn inside this circle to indicate how far away the optimal position is. The filled circle gets smaller as you get closer to the optimal position.

Optimise Selected Nets - Optimise is completed based on the current selection.

Free Angle Adjoining Segs - If a routed Component has tracks exiting its pads orthogonally, the Free Angle Adjoining Segs option will allow the track end segments to become free angle segments losing their orthogonality. To subsequently restore the free angle segments to 90 degree segments, the tracks must be edited and the segments reinstated.

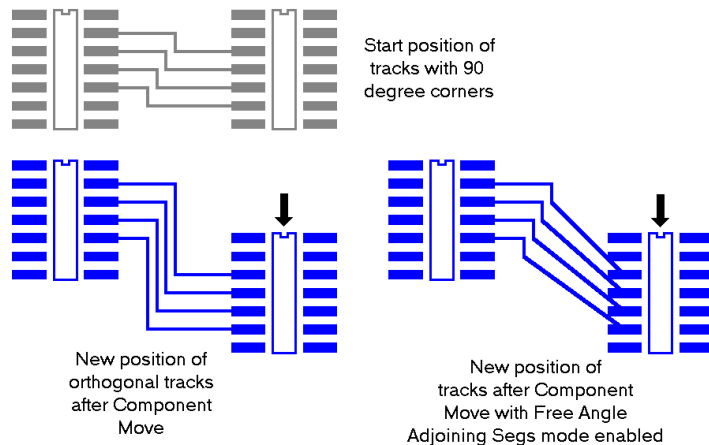

Auto Weld Now - With the Auto Weld option switched off in the **Options** dialog, you can weld items on command.

Push Mode - Whilst moving components, the option is available to push other components out of the way in order to make room for the moving Component. Components that are locked will not be pushed, and components will not be pushed outside of the board outline.

The following parameters govern the Push Aside characteristics:

Continuous - Stationary components are continuously pushed out of the way whilst moving components.

Never - No push aside is attempted when this is set to Never.

On Drop - You can move the components and when dropped, any components in the way will be moved aside to make room for the dropped ones. The direction they are pushed is controlled by the **Push Direction**.

During **Push Aside**, the **Optimum Component to Component** spacing defined in the **Design Rules** page on the **Technology** dialog is used in order to space the components out. The outer boundaries of the Component are defined as the maximum extents of any Placement or Silkscreen outlines, and Pads/Mounting Holes.

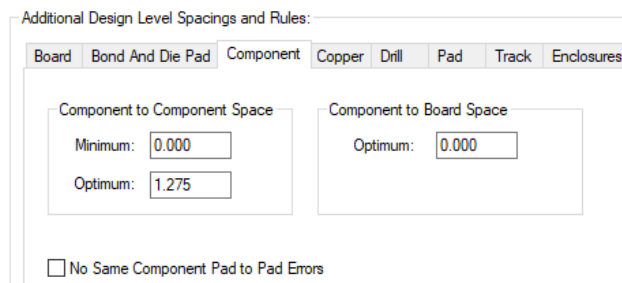

Following placement, the **Minimum Component to Component** space is used by the **Design Rule Check** option to check for overlapping components, again, using the Component boundaries for checking. Boundaries are taken to mean the Component Body Area or Component Clearance Area if defined in the Footprint. If these haven't been defined, the option will use the maximum extents of the component bounding box as its boundary. Additional rules apply to component body and clearance areas when placed alongside each other.

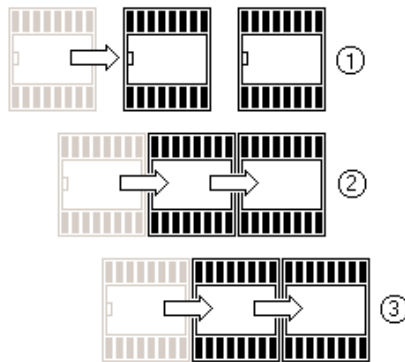

In the diagram above, figure ① shows Component Move being initiated by the Component at the front. At this point, the components still have their original placement position and spacing. ② shows how, during the pushing sequence, each Component 'butts' up against the next using the *Component To Component* spacing. ③ As the components are pushed, they now start to move together, adhering to the Component spacing rule.

Push Direction – enables the direction that the stationary components will be pushed to be defined – the choice is **Horizontal**, **Vertical** or **Both**. The example below shows how the Component would be pushed in the vertical direction if Vertical was selected.

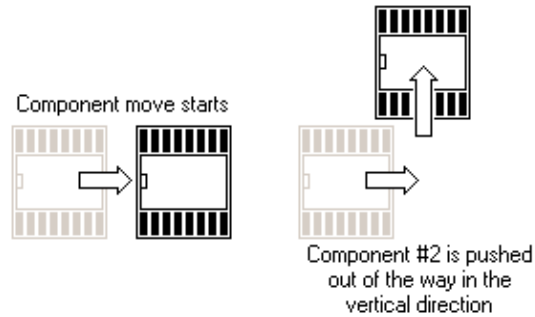

Spring Back – With this switch selected it will enable a Component that has been pushed out of the way, to return to its original position once the pushing Component has passed or cleared the position. It is only relevant when Component Pushing is enabled. When the Push mode is set to Never, Spring Back is disabled regardless of its switch setting.

From the **Change Grid** option you can change the grid to use during Component placement when using Move, and get to the **Grids** dialog from where the grids can be changed. Once a Grid has been selected, each time you come back to move components they will use that grid.

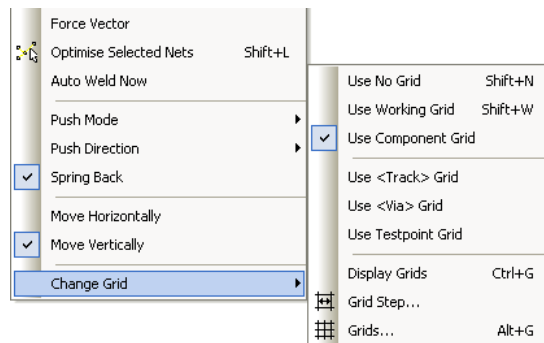

From this menu, you can switch the **Screen Grid** on or off. It is quicker to use the default keyboard shortcut for **Display Grids** of <Ctrl-G>.

Component placement features available on 'select'

These features are available when a Component is selected but not in Move mode or being moved.

Lock/Unlock

This provides the ability to fix a Component in place so that it cannot be moved. A lock status will also disable other functions being performed on it until unlocked, e.g. Move to Bin etc.

If you attempt to move a Component that is locked a dialog is displayed.

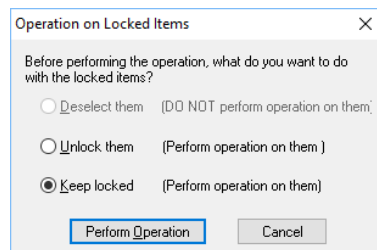

This provides you with the option to perform the option anyway, to cancel or to deselect the Component.

Nets>> Optimise Selected Nets - With any components selected a single Component optimise can be performed. The nets attached the selected Component will be reconnected to the nearest node points to create the shortest connection length.

Nets>> Unroute Selected Nets - Any tracks attached to selected components will be unrouted back to connections for the complete net, including any changes to layer and vias. Care should be taken using this option as the complete net will be removed back to connections, including connections spanning any number of components.

Nets>> Autoroute Selected Nets - when used on a selected components all nets attached to the Component will be routed automatically using automatic routing properties.

Reload From Library will reload the Component instance on the design with one from the library. A small dialog is displayed that provides you with a selection of switches to define how to reload the Part from the library. This option would also be used if the **Edit Part in Library** or **Edit Footprint in Library** options have been used.

Edit Part in Library - The system will look for the Footprint with the same name as the Footprint the selected Component uses in the available footprint libraries. These libraries are defined using the **Library Folders** facility. If the Footprint is found it is read from the library and opened for you to edit.

This is just the same as if you used the **Library Manager** to edit the footprint. The **Technology File** used for the footprint will be the current selected Technology file from the Library Manager PCB footprint dialog.

Edit Footprint in Library - The system will look for the Part with the same name as the Part the selected Component uses in the available Parts libraries. These libraries are defined using the **Library Folders** facility. If the Part is found it is read from the library and opened for you to edit.

This is just the same as if you used the **Library Manager** to edit the Part. The **Technology File** used for the Part will be the current selected Technology file from the Library Manager Part dialog.

Move to Bin enables you to send any selected components to the Component Bin. Components that are locked will not be sent to the Bin. Components that have tracks attached can be sent to the Bin but the tracks are lost, the tracks are returned to connections so the connectivity is not lost (it is unusual to send routed components to the Bin unless performing design modifications). In any case, a warning dialog is displayed for you to confirm the removal of the tracks before sending them to the Bin. If you press **OK** but mistake, **Undo** can be used to recover the situation.

Using the Properties option to move components

When a Component is selected the **Properties** option displays information about the components.

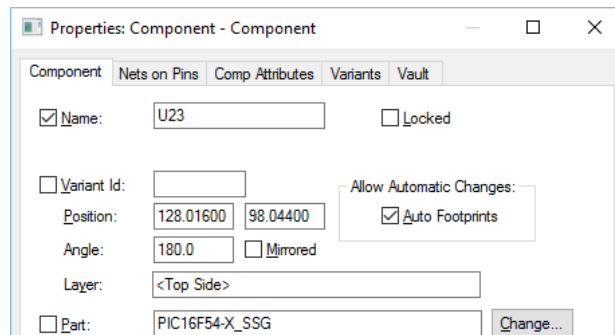

Fields that are not editable are displayed greyed out. This dialog enables you to change **Component Names** and their position using the co-ordinates displayed. This dialog also enables you to change the components **Rotation**, **Mirror** and **Lock** status as well as the **Part** type, and **Footprint**.

Adding Connections

Connections are used in Pulsonix to indicate the point-to-point connectivity of the netlist. When using Pulsonix in 'interactive' design mode and designing PCBs on-the-fly, the ability to add connections or tracks directly is essential to create the netlist. This design practice is easy to accommodate using some basic modes of operation.

PCB Safe mode

However, Pulsonix also features a design setting to allow or not allow the PCB netlist to be modified. The **PCB in Safe Mode** of operation would be used when a 'master' Pulsonix Schematic or external netlist is being used. This would mean that with the switch checked, no modifications can be made, including addition or removal of connections. By default, this switch is set Off (unchecked) so that modifications can be made.

If using the PCB design as the 'master' (rather than the Schematic), you should uncheck this switch so that PCB modification, like adding connections or Parts, can be made.

The **PCB in Safe Mode** switch is located on the **Design Settings** dialog under the **Synchronise** tab.

PCB in Safe Mode

Allow PCB Only single pin nets

Synchronised Design Name
Name:

Back Annotation
 Enabled

Synchronise with Schematic

- Apply All Rules Strictly
- Apply Spacing Rules
- Apply Footprint Changes
- Apply Net Class Changes
- Apply Net Colours
- Apply Schematic Track & Via Size Rules to Net Styles
- Apply Schematic Title & Subject
- Ignore Attribute White Space
- Allow Update of Schematic to match PCB

Connection Properties

Connections or Nets carry a number of properties that give its characteristics. These are:

- A user defined Net Name or default Net Name
- A Net Class that itself contains: Track style, Via style, Guard Spacing
- Attributes (if applied to the Net)

These properties have been discussed in detail previously in this Chapter under *Setting Up A PCB Technology*.

Connections can be connected to a number of electrical items:

- Pads, Free pads and Mounting Holes, Testpoints, Vias

- Tracks
- Copper, Copper Pouring Template areas

For most of these items the attaching of connections is straightforward and obvious in use. For some though they require more explanation:

Vias – connections can be attached to an existing via. Once routed, the track will then ‘copper share’ the existing tracks.

Tracks – a connection can be added anywhere on a track that means that it will ‘copper share’ the existing tracks or nets back to the connection node. Once routed, this connection will act as though it has been created as a track but overlaid on an existing track of the same net and following the same routing path. This situation may be created to form a ‘T’ route.

Copper – connections can be attached to copper items so that the copper is attached to a particular net.

Templates – by attaching a net to a Template, when poured the copper will inherit the net name. This means that when the shape is poured, it will automatically associate itself with the attached net name.

There are also ‘Wire’ items in the Pulsonix product, these are not the same as connections. Wires are used as ‘jumpers’. These are discussed later on.

Default Connection values

When adding a Connection to the design, the default values it uses for **Net Class**, **Name Layer** and **Name Style** are defined in the **Design Settings** dialog under the **Default Tab** and **Nets**.

The **Name Layer** and **Style** are used when **Show Net Names** is enabled.

Inserting Connections

► To add connections using Insert Connection

1. From the **Insert** menu, click **Insert Connection**.
2. Click on the first pad to start the connection, click on the second ‘target’ pad. A connection will be made between the pads.
3. Move the cursor to the next item and click to make another connection. The insert connection mode works in ‘daisy’ chain from one point to the next until released.
4. Press <Esc> to end Insert Connection mode.

During **Insert Connection** you can also use the context menu that allows additional options:

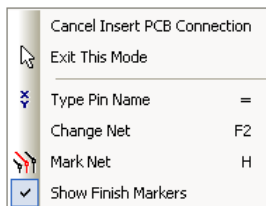

Type Pin Name allows you to start a connection on a pad or add to the next pad by typing its name, for example, click to start the connection and then type in IC2.9 in the Type Pin Name box to connect to the IC2 pin 9.

Change Net allows you to add or change the existing Net Name of the connection. The standard Change Net dialog is displayed. This is discussed in the next section, *Managing PCB Nets*. This option is available during the Insert Connection operation.

Mark Net is used to highlight the complete net so that you can view the complete net path within the design. This switch toggles the Mark Net option on and off. This is very useful and is also assigned to the shortcut key <H>.

Show Finish Markers switches on and off the finish markers and is directly linked to the **Options** dialog.

Once added to the design, if you select the connection and right mouse click, the context menu displays a number of options:

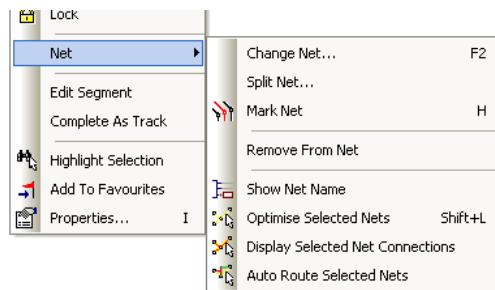

The Select option displays a number of **Selection** and **De-selection** options as well as **Select Next** and **Select Previous**. This will allow you to select the next item under the current cursor position, likewise, will allow you to select the previous item. This is used when the cursor is above a number of connections in a tight area.

The **Edit** option opens to the standard **Cut**, **Copy**, **Paste** and **Duplicate** options.

You can apply a 'Lock' status to a connection that disables it from being **Optimised** or **Deleted**.

Nets will reveal the options **Change Net**, **Split Net**, **Mark Net**, **Optimise Selected Nets**, and **Route Selected**. Split Net is discussed in more detail in the section below, *Managing PCB Nets*.

Edit Segment - once the connection has been added you can double-click on it or use the Edit Segment mode from the context menu to start routing it.

Remove From Net is used to remove any connections from the selected net.

Show Net Name this displays the net name on the selected net. The Style of the text used for the net name can be changed once displayed by selecting it and pressing the S key for Style.

Properties displays the characteristics of the Connection, Net and Net Attribute. You can have any number of net **attributes** that can hold characteristics for other purposes, e.g. routing, simulation or Guard Spacings for additional spacing clearances on that net.

Managing PCB Nets

By default, any connection added to the design will contain a default net name. This name can be changed during the addition of the connection or renamed afterwards.

Setting the default net name suffix

Pulsonix is installed with pre-defined. Obviously, these settings can be changed if not suitable but care should be taken when changing them. You should only change them if you know what you're doing. Use the **Design Settings** and **Naming** dialog to do this.

Force To Upper Case <input checked="" type="checkbox"/> Component Names <input type="checkbox"/> Gate Names <input type="checkbox"/> Net Names <input type="checkbox"/> Part Names <input type="checkbox"/> Pin Names <input type="checkbox"/> Test Point Names	Name Options <input checked="" type="checkbox"/> Case Sensitive Pin Names <input type="checkbox"/> Numeric Gate Names <input checked="" type="checkbox"/> Fill-In Gaps In Number Ranges <input type="checkbox"/> Case Sensitive Drill Size Idents
Default Net Names Name Stem: <input type="text" value="\$"/> Number Width: <input type="text" value="3"/>	Name Ranges Range Start: <input type="text" value="["/> Range End: <input type="text" value="]"/> Range Separator: <input type="text" value="-"/> Item Separator: <input type="text" value="."/> Example: U1,U[3-6]
Pin Names Component to Pin Name Separator: <input type="text" value="."/>	

When you add a new net to the design, it is assigned a default name. This can subsequently be named if you so wish, but this part of the dialog is concerned with the format of the default names. The default name consists of an optional stem followed by a number (that are allocated sequentially). The name stem is specified in the top *Name Stem* control. The *Number Width* control specifies the minimum width of the number that will be padded to the left with leading zeroes. For example, a name stem of 'Net' and a number width of '2' gives net names of the form 'Net01'. You can change these values after you have begun designing, but this will result in nets being renamed that could be undesirable.

Using default Net Name properties

Nets have a number of default properties - Net Name, Net Class and a Connection Width.

Nets that are not named will automatically be assigned a default Net Class and display width when added to the design. As previously described, these values are taken from **Options** and the **Defaults** dialog.

Nets that have previously been named in the Technology file will already have a Net Class assigned to them, and subsequently will also have a connection thickness.

Naming Nets & Renaming Nets

At the addition of connections or the editing of connections you can name them using your own name as an alternative to a system default net name. You can press the <F2> shortcut key that will display the **Change Net Name** dialog. This option is also available on the context menu.

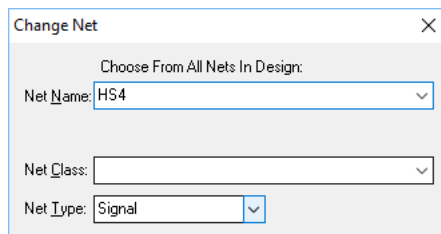

The 'Change Net' dialog box contains the following fields:

- Choose From All Nets In Design:** A label above a dropdown menu.
- Net Name:** A text input field containing 'HS4'.
- Net Class:** A dropdown menu.
- Net Type:** A dropdown menu containing 'Signal'.

From the drop down list you should type the name of the net into **Net Name:** or select its name from the drop down list presented. Using this dialog, the **Net Class** can also be selected from the drop down list.

Splitting Nets

Use the **Nets** and **Split Nets** options from the context menu when a **net is selected**. This allows the net to be split in ‘two’, creating two nets from the original one. A dialog presents the options from which to choose:

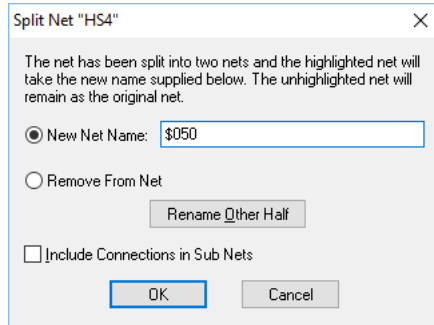

The original net name is displayed at the head of the dialog and the new name displayed in the **New Net Name** box. A default net name is displayed, this will be the next available in the sequence and will be unique, you can type in your own net name as required.

The **Remove From Net** button is used to remove the split net instead of renaming it. All connections and tracks in the split net will be removed and all remaining items in the split net will be removed from being on a net.

You cannot split a net when the removal of the selected PCB connection or Track does not result in the net being split into two. For example, when the connections form a loop and one is removed, or when the selected item is not on an isolated part (subnet) of it's net. In these two instances, an error message will be displayed.

Use the **Rename Other Half** button to swap the names of the two nets. The two nets alternate between being highlighted. Use this to show where the two nets are, and to choose which net remains as the old net name.

Deleting Nets

As discussed previously, the Delete option cannot be used to remove nets from the design. You must use either **Split Net** or **Remove From Net**.

Select the net and use **Remove From Net** from the context menu. When a **Connection** or **Track** is selected, it will be deleted and the items that were at each end of it will be removed from the net **only** if they do not have any other tracks or connections attached.

Back annotating name changes

The Back Annotation of design information to the Schematic is covered in more detail later on in this Chapter under *Back Annotation to the Schematic Design*.

Optimising Nets

Optimise will create a connection pattern which represents the shortest distances between unconnected subnets in a net. A subnet is a collection of items on the net that are already physically connected. You would normally want to route all these connections, so that there are no longer any connections in the design.

There are three **Optimise** options available from the **Tools** menu, **All Nets**, **Browse** and **Selected Nets**.

Optimise All Nets is used to perform optimise on all the nets in the design in a single operation.

Optimise Browse Nets will only perform optimise on the nets you select from a browse dialog.

Optimise Selected Nets will only perform optimise on the currently selected nets in the design. This option is also available on the context menu for a selected Component or for any selected net in the design.

You can use the **Optimise Nets** option in a **Latched Mode**, this means that you select the option first, and then interactively select design items on nets you wish to Optimise. This continues until you deselect the option or select another option.

Once any nets have been optimised, the overall connection length can be checked by running the **Connection Length Report** from the **Reports** option on the **Output** menu.

Manual Gate and Pin Swapping

Gate and Pin Swapping are the processes for exchanging (Swapping) Gates and/or Pins of like devices either between Parts or between gates and pins of the same device to shorten the connection length between them.

Gates are the internal ‘packages’ within a device that make up the complete Part. For example, a 7400 is made up internally of 4 identical NAND gates.

These gates are the same and therefore could be swapped if allowed and defined in the Parts library.

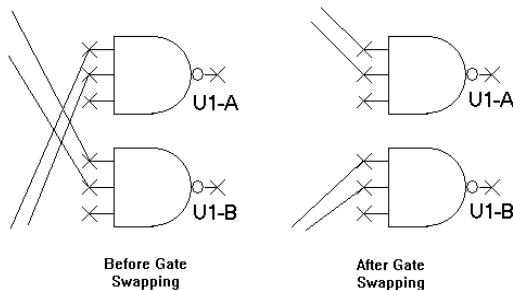

Gate Swaps

This is used to swap all connections between two equivalent gates. Two gates are equivalent if they are in components that have the same Part type and are in the same swap group in the Part data.

When used, the gate swap is recorded in the **Back Annotation** data used for updating the corresponding Schematic design.

The Back Annotation data can be viewed using the **Back Annotation Report** available from the **Output** menu and **Reports** option.

► To swap Gates

1. First select the **Swap gates** option on the **Utility** menu.
2. Choose the first gate on the component.
3. Use the mouse to move the cursor over the component pads in the design. If a pad is part of a gate that can be swapped, all pins on that gate are drawn in the select colour whilst the cursor is over them. The name of the selected gate is reported on the status bar.
4. Click on the selected gate that you wish to swap.
5. After the first gate has been selected, all equivalent gates that can be swapped will have their pads drawn in the highlight colour.
6. Choose the second gate by clicking on the selected pad to choose the second gate for the swap.
7. As soon as two gates are selected the connections are swapped between the corresponding pads on them and the swap is recorded in the design's back annotation data. All gates are then de-highlighted and deselected ready for the next set of gate swaps.

Swap Rules

The following rules restrict the swapping of Component gates:-

- A gate can only be swapped if all pins have no routes attached.
- The two gates must be on components of the same part.
- The two gates must be in the same swap group in the part data.

If no swaps can be performed because the Part's swap data is not set up, use the **Part Editor** option to add the swap data to the Part in the library. Once completed, use the **Reload From Library** option to update the components in the design.

The contents of the Parts library and how to create this information is discussed in detail in the Chapter on the *Library Management Tools*.

Pin Swaps

This is used to swap all connections between two pins. There are two modes of operation.

- Normal operation is to only allow the swap of two pins that are equivalent. Equivalent pins are on the same gate, within the same Component, and in the same swap group. In this mode the swap is recorded in the Back Annotation data used for updating the corresponding schematics design.

The Back Annotation data can be viewed using the **Back Annotation Report** available on the **Outputs** menu under **Reports**.

- The other mode is to allow swap of any pins in the design. In this mode the swap is not recorded for back Annotation. This may be useful in some cases, but is not recommended as it could lead to synchronisation problems with the Schematic design.

► To swap Pins

1. First select the **Swap Pins** option on the **Utility** menu. If **Swap Any Pins** mode was last used, you will be asked to confirm to continue in this mode.
2. Use the context menu **Swap Any Pins** option if you wish to disable the normal swap mode. You must select a pin on a Component before this is available on the context menu.

3. Choose the first pin.
Use the mouse to move the cursor over the Component pads in the design. Note: if a pad can be swapped it is drawn in the select colour whilst the cursor is over it. Click on the selected pad that you wish to swap.
4. After the first pad has been selected, all equivalent pads that can be swapped will be drawn in the highlight colour. If allowing **Swap Any Pins** no pins will be highlighted as all pins can be swapped.
5. Choose the second pin.
Move the cursor over the highlighted pads in the design. Click on the selected pad to choose the second pad for the swap.
6. As soon as two pads are selected the connections are swapped between them and, if the normal swap mode, the swap is recorded in the design's back annotation data. All pads are then de-highlighted and deselected ready for the next set of pin swaps.

Swap Rules

The following rules restrict the swapping of a Component pin:

- A pin can only be swapped if it does not have any routes attached.

The following rules apply when using the normal swap mode:

- The two pins must be on the same Component.
- The two pins must be on the same gate within the part data.
- The two pins must be in the same swap group in the part data.

If no swaps can be performed because the part's swap data is not set up, use the **Part Editor** option to add swap data to the part in the library. Use the **Reload From Library** option to update the components in the design.

The contents of the Parts library and how to create this information is discussed in detail in the Chapter on the *Library Management Tools*.

Swapping Routed Gates & Pins

When attempting to swap routed gates and pins you have two options **Swap Routed Pins** and **Attributes Must Match**.

The **Swap Routed Pins** option exists on the context menu when using **Swap Gates** or **Swap Pins**. Check it to allow selecting of pins that have routes attached. The track segment attached to the pad will be unrouted prior to swapping.

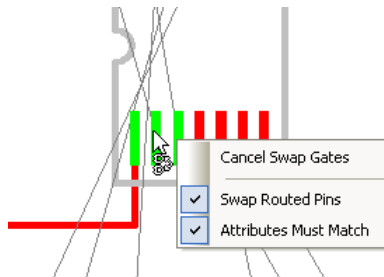

The **Attributes Must Match** option command exists on the context menu when using Swap Gates. Check it to only swap gates between components that have the same attributes (this is how version 4.0 worked), or leave unchecked to ignore attributes.

Manually Routing the Design

Manual routing is the process of adding copper tracks in Pulsonix. This can be done by ‘converting’ connections into tracks, or by adding tracks directly into the design.

Pulsonix allows you to work using one of three fundamental ‘modes’ when creating a PCB and subsequently routing the design (and this excludes the automatic routing process for now). You can start a PCB design starting:

1. With a netlist, from an external source to Pulsonix, or from a Pulsonix Schematic design translated into the Pulsonix PCB design editor, the routing would be edited in by converting the connections to tracks.
2. From within the PCB design directly and adding in the connections on-the-fly to create a PCB only netlist. From the connection based netlist, the connections would be edited into tracks. This would be used in preference to 3) below if a full or mainly complete netlist is required for checking before tracking has commenced and differs from 1) in that because the netlist is derived on-the-fly it is more prone to errors unless carefully checked. Using the known netlist allows system options to do the checking for you, as well as correcting any synchronisation problems between the PCB and the master schematic.
3. By adding in new tracks directly without a netlist. A design created truly ‘on-the-fly’ but no less as accurate as with a connection-based netlist (the tracks actually provide an underlying netlist).

In addition to manual routing methods, you also have the automatic routing option that can be used to accelerate this task. The auto router is discussed in the Advanced Features Users Guide supplied as a PDF file in this installation.

Starting to route tracks manually

To start editing connections (and subsequently convert them to tracks) you can:

Double-Click on a connection, or;

Select the connection and right click, select **Edit** from the menu, or;

Select **Insert Track** from the **Insert** menu. Select the connection or track to add the track to.

If adding tracks into a PCB design without any previous netlist or connections you can use the **Insert Track** option or double click over a Component pad to start the track.

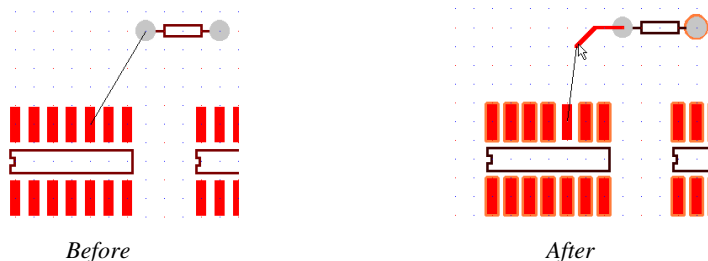

The two illustrations above show the how the design looks before manual routing has started, and how it looks once a connection is edited. Also shown are the Display Clearances around each object.

Overview of the basic modes of routing

The basic commands for editing tracks are:

Single-Click, once editing, will insert a corner and enable you to change direction.

<L> (**Change Layer**) followed by <Enter> will enable a **layer change** to the opposite side of the design.

Ctrl-Click will add a via and change layer while routing.

S (Change Style) followed by <Enter> will enable the style of the track to be changed to the alternative track style defined in the **Net Class**. If this is thinner than the current style, a ‘necked’ track will be started.

Double-Click while editing a track will activate a **Route to Finish**, the double-click functionality can be user defined in **Options** and **Edit Track**. It will add a track directly from the last corner inserted to the end target pad, it will not add any corners or layer changes. If a layer change is required to finish for a surface mounted pad for example, a via will be automatically inserted.

Shift-Click will always force a corner on the track. This is used when a track is over another item and the **Finish Here ‘F’** marker is being shown, Shift-Click will insert a corner and not finish until required.

As with most features in Pulsonix, there are multiple ways of entering a mode of operation. This section will concentrate on the methods that are the most productive for use.

Setting up the options

Most of the options available during manual routing can be pre-defined ready for use using the **Edit Track** tab on the **Options** dialog. You can also access all of these options from the context menu when routing.

Segment Mode: **45 Angled** Apply Seg Mode to Tail

Interactive Mitre/Fillet
Size: Any Angle

Auto Corner
Tolerance:

Show 'Can Finish' and 'Has Loop' Markers Remove Loops
 Show Legal Completion Path Auto Share Tracks
 Always Mark Net being edited Allow Nets to be joined
 Clear Mark when edit complete End On Via - Adds Protected Via
 Show Connection to Nearest Node Use Style From Picked Track
 Show Dynamic Connections Only Obstacle Avoid
 Optimise After Edit Auto Finish
 Next Layer - Use Bias Change Layer - Return To Previous Layer

Double Click Operation
 Complete Track
 Finish Here
 Finish On Via
 Swap Layer

Track Pushing
 Spring Back Push Vias
 Pull Tight Plough

Auto Correct Track
 Mitre Result

Auto Necking
 Auto Neck
 Pad Auto Neck

Add a Differential Pair Track Using:
 Single Track Mode
 Mirror Mode
 Pairing Start Mode

Sketch Track
 Use Point To Point Mode Mitre Result
 Use Grid When Sketching Use Any Layer

Track Hugging
 Always Uses Minimum Gap
 Hug Method: Shielding Routing Gridded

Area Based Styles
 Stop at Border Until Clicked
 Automatically Change Style at Border
 Change Style at First Corner

Context Menu:
 Cancel Add Track
 Exit This Mode
 Finish Here
 Type Coordinate... =
 Type Offset... Shift+=
 Finish On Via
 Complete As Track
 Change Layer L
 Next Layer
 Previous Layer
 Change Style S
 Change Net F2
 Mark Net H
 Change Default: Via Style
 End Track On
 Start Track Hugging
 Editing Options
 Segment Mode
 Change Segments
 Online DRC \\\n
 Display Clearance
 Push Mode
 Change Grid

Track Segment Modes

This defines the default restrictions on the orientation of segments when creating or editing a track. You can change the **Segment Mode** at any time whilst creating or editing a shape by using the **Change Segments** option on the **Edit Track** context menu.

Free Angled

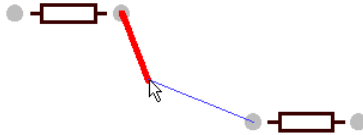

Any-angle segments can be used when editing a track with no restrictions to the segment orientation, this creates a free angle track segment.

Orthogonal

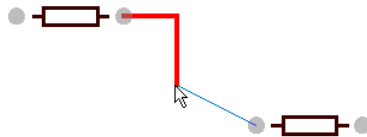

Only 90 degree segments are inserted using two trailing segments to create the angle using alternate vertical and horizontal segments.

Orthogonal (Mitre)

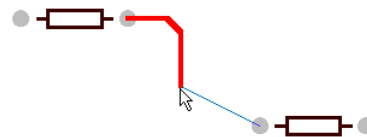

Alternate shape segments are vertical and horizontal lines with the corner being a 45 degree mitre.

Orthogonal (Fillet)

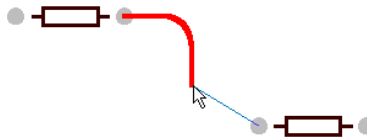

Alternate shape segments are vertical and horizontal lines with the corner being curved.

45 Angled

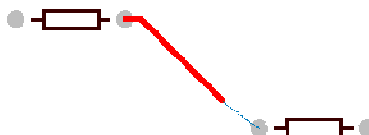

Alternate shape segments are orthogonal and 45 degree lines. A 45 degree angle is inserted when a corner is added. When the mouse is being moved horizontally and vertically, 90 degree tracks are added.

45 Angled (Fillet)

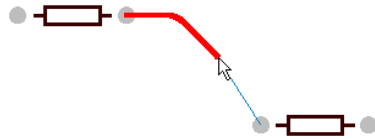

Alternate shape segments are orthogonal and at 45 degrees with the corner filleted.

Curved

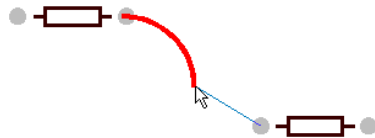

Alternate shape segments are orthogonal and 90 degree curve. Like the 45 degree mode, where corners are required a curved corner is added.

Pull Tight

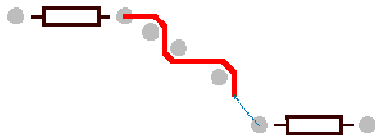

Pull Tight is a special mode which will produce a minimal orthogonal and 45 degree pattern. This mode will automatically add corners to wrap or 'hug' around obstacles using the shortest distance possible, pulling tight all the time. In this mode you can automatically remove any corners that have been added by re-tracing the cursor back over the track.

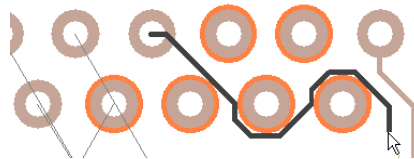

Restricted Movement

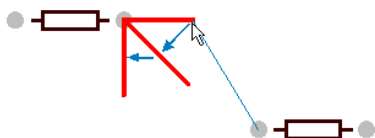

Restricted Movement is a special mode which will restrict the movement of the current segment by snapping its angle to 45 or 90 degrees in whichever direction you are predominantly moving the cursor. Clicking the mouse adds a corner.

Segment Mode on Context Menu

Alternatively the segment type may be selected on the context menu using **Segment Mode** and selecting the mode type to be used.

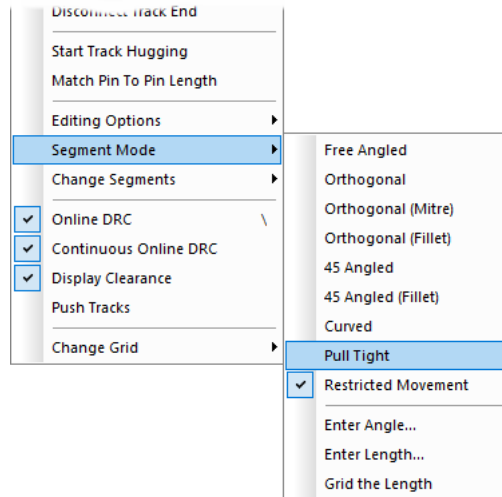

Orthogonal Mitre (Auto Mitre) and Curved Mitre

During track editing, the completion of an individual segment within the overall track is determined by a single click, normally followed by a change in track direction. With **Orthogonal Mitre** (Auto Corner) set, a change in direction with the cursor will indicate that a corner or angle should be automatically inserted.

With orthogonal routing it may be desirable to mitre the 90 degree angles and with Auto Mitre set a mitre is automatically inserted at each 90 degree intersection.

If this option is checked, this defines the size and shape of mitres that are added when the Segment Mode is **Orthogonal**. Mitres differ from the **Angled (45)** and **Curved (90)** Segment Modes because the mitres are of a fixed size that is specified in the **Size** edit box. The **Size** is the orthogonal width and height of the mitre not the distance across the mitre segment. The mitres can be a 45 degree straight line (**Mitre**) or 90 degree curve (**Fillet**).

Mitre

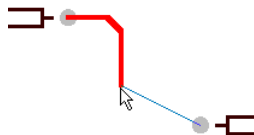

Mitre gives fixed size 45 degree angled segments.

Fillet

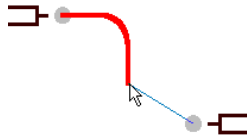

Fillet gives fixed size 90 degree curved segments.

Auto Corner

This is an advanced editing feature that allows tracks to be drawn without having to click the mouse at each corner. (Note, this feature does not operate in **Free** segment mode).

You must define a **Tolerance**, this is the distance the cursor must move away in a perpendicular direction from the first segment you are adding before a corner is added. You can still click at any time to add a corner. It is recommended that the **Tolerance** is larger than any grid and mitre size you are using.

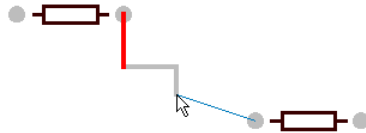

In the example above, the cursor is at the bottom of the second selected segment (shown as a lighter colour). As you move right the first selected segment gets longer. When you move down so that the second selected segment is longer than the auto corner tolerance, a corner is added and the first selected segment is complete.

Apply Segment Mode To Tail

When checked from the **Options** dialog or selected from the context menu under **Editing Options** > **Apply Segment Mode To Tail**, this mode applies the same segment mode to the lead and trailing segments when editing an existing track segment.

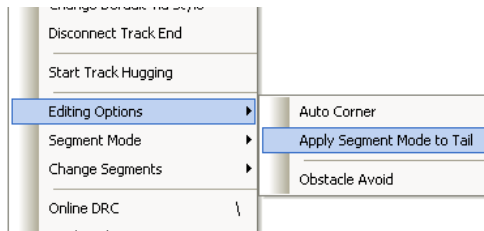

No Seg Mode To Tail

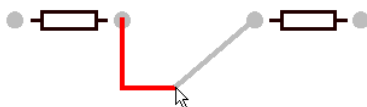

Trailing segment is at a free angle.

Apply Seg Mode To Tail

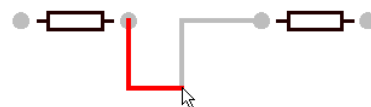

Segment mode is applied to the trailing track segment.

Show Finish Markers

These take the form of **Modal Cursors** or, if **Modal Cursors** not enabled through the **Options** dialog and **General** tab, then dynamic markers are drawn in the highlight colour. They appear at the cursor position to indicate that clicking would do something different from just the normal add corner. The following 3 Markers exist: **Can Finish Here**, **Can Finish On Via** and **Remove Loop**

Can Finish Here

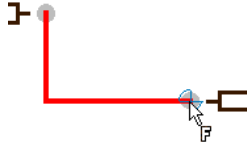

This will display the '**F**' finish marker when nearing the terminal node on a single track route. As you get close to an electrical connection point for the track you will see an **F** appear on the cursor, this is the finish marker. As soon as the **F** appears on the cursor then a single left click on the mouse will command the system to finish the final connection and attach it to the item underneath the cursor.

Can Finish On Via

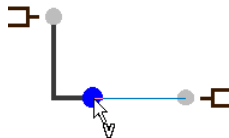

Control Click whilst this marker is shown will result in the track being finished on a via through to the item underneath the cursor.

Remove (Track) Loops

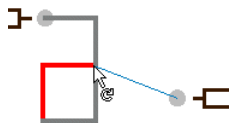

This is used to allow loop removal when tracks are finished. This is the normal mode, but occasionally you may want to create loops in tracks. If this mode is not checked, the loop removal marker is not used. Loops will only be removed within the track path, not anywhere on the net. Loops may be required on specific nets such as power or ground, or on nets that are required to create 'rings'. Left click whilst this marker is shown will result in a loop in the track being removed from the track.

Auto Share Tracks

This is used to automatically remove overlaid tracks after finishing editing or moving a track. A junction will be created where the overlaid tracks end. If this option is not checked, any overlaid tracks will remain overlaid. You can use the **Share Tracks** option to remove all overlaid tracks in the design at a later stage.

Allow Nets to be Joined

Allow Nets to be Joined will give you the ability to join nets with different net names. With this mode switched off, you will not be allowed to join any different nets together. The overriding switch on this is the **Can Alter PCB Netlist** switch on the **Design Settings** dialog under the **General** tab. If this switch is unchecked to not allow changes then the **Allow Join Nets** switch is inoperative.

Always Mark Net Being Edited

Use this to show the net currently being edited in the **Marked Net** highlight colour.

Show Connection to Nearest Node

Use this when adding tracks to show a line (connection) between the moving cursor and the nearest item that you can finish on the same net. With the option selected, the connection is shown to the nearest node. This may not necessarily be the original target pad but will be the closest node to make a legal track end. This will also allow you to connect to track segments, copper items, vias or testpoints.

When editing a connection you get two lines from the cursor, one to the nearest node and one to the original connection end.

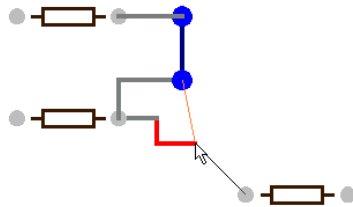

Double Click Completes Track

Check this so that when adding a track, double click attempts to finish the track to the end of the attached connection. It will use the current segment mode to complete the track. If **On-line DRC** is enabled in **Continuous** mode and there is an obstacle in the way of the attempted finish path, a more intelligent routing algorithm will be used to try to complete the track. Uncheck it to let double-click finish the track in space.

Setting up Default Values

There are default track settings for **Tracks** in **Design Settings** dialog on the **Defaults** tab.

Layer 1 and **Layer 2** define the swap layer pair used during routing. When routing you can swap between these layers when using **Change Layer**.

Track Style is used to define the style used when adding a track directly into the design without using a connection. In this mode, the track will also pick up the default **Net** characteristics also defined on this tab. The actual track thicknesses are set up in the **Technology** dialog under **Track Styles**.

Options available on the context menu

There are modes of operation that can only be accessed from the context menu during **Insert Track**. These are discussed below, where functionality is common this will have already been discussed above.

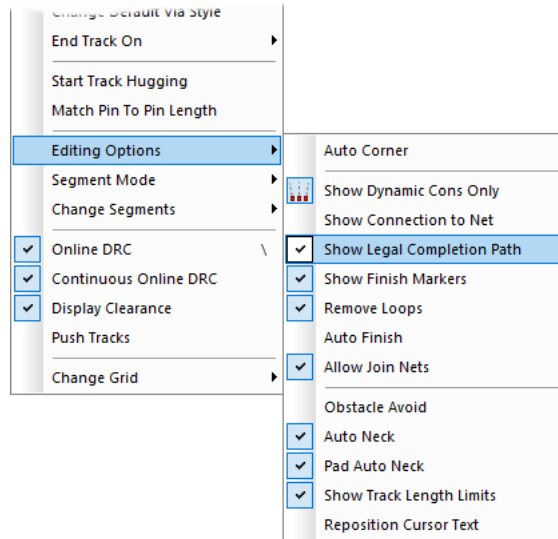

Cancel Add Track - This exits you from this option completely without saving the routing.

Finish Here - Finish Here will finish the editing of the track from the current mouse position and will leave a 'flying' connection back to the end pad.

Complete as Track - At any stage during insert track mode you may command the system to complete the single track route automatically. In **Insert Track** mode use the context menu and click **Complete As Track**. The system will attempt to finish the route. This function does not use the standard autorouter and should not be seen as a replacement for this, a more sophisticated product.

Changing Layers

To change layer, in insert track mode use the Shortcut Key <L> or the **Change Layer** option.

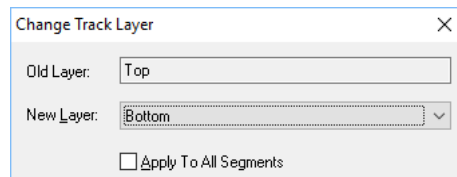

The required layer may be selected from **New Layer**. If track segments are already placed, then in switching to a new layer a via will be inserted at the default size. A quick way to use this option is to set up the swap layer pair in the Options dialog and Defaults. When the **Change Layer** option is selected, you will automatically be presented with the alternative swap pair layer. By pressing <Enter> you will automatically insert a via and swap layers. This means you can swap layers very quickly by pressing <L> <Enter> without looking at the dialog.

Another useful shortcut is **Ctrl-click** will add a via and change layers while routing. This will switch tracks to the bottom of the board and hence this shortcut is not suitable in a multi-layer design where in inner layer is to be selected.

Changing Track Styles (or Track Widths)

To change track styles during **Edit Track** mode, right click the mouse and select **Change Styles** or use the Shortcut Key <S>.

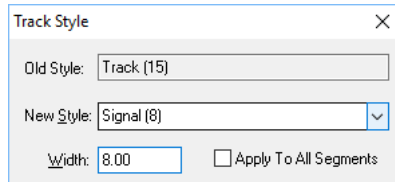

A **New Style** may then be selected from those predefined in the Technology dialog. In the Width box a size may be inserted that is not currently defined in the Technology file. A new style name will be offered and this new style will be included in the Technology. You can also type in the name of the new style.

A quick method of ‘necking’ a track (the process of changing the track from a fat width to a thin width, or vice versa) can also be obtained using this dialog.

By default the New Style offered will be the alternative style defined for the track in the Net Class dialog. This is defined in the Technology dialog under Net Classes.

If using a thicker width, and by default the style used will be the Nominal style (Nom. Track) defined, you can instantly get to the thinner style (Min. Track) by pressing **S** followed directly by **<Enter>**. So as with changing Layers, you can select the alternative Style by pressing **<S>** **<Enter>** without looking at the dialog.

Change Net

This is used to change the net of the net being edited. This has been described in more detail previously in this Chapter under *Managing PCB Nets*.

As a shortcut, it is quicker to use the default shortcut key of **<F2>** to get to the **Change Net** dialog.

Mark Net

Mark net is used to highlight the current selected net using the **Highlight** colour. A predefined shortcut key **<H>**, enables you to toggle the highlight on or off quickly.

Change Default Via Style

This allows you to change the default via style set in the **Net Class** setting for this Net Class name. If a name is typed in and is not in the existing **Styles** dialog for vias, you are prompted to add it in or keep the style local.

End Track On

The system may be commanded to end the track on a Via or a Testpoint Via. In track insert mode r/h mouse menu and select **End Track On**. A menu opens with the following options:

Via - This will add the net class default via style to the end of the track.

Testpoint - This will add a testpoint to the end of the track segment

None - No via or testpoint is inserted on the end of the track segment

Editing Options

These are the track editing options (Auto Corner, Auto Mitre etc.) already discussed above.

Change Segment options, Next, Previous etc.

Segment Mode options (Free, Angled, Orthogonal etc.) have been discussed above.

Edit Segment

When editing track segments, these modes give the opportunity to 'back-track' to predefined locations along the current track segment without exiting the edit and starting at the location required on the same track.

First - The first segment of the track, default shortcut key **Home**.

Previous - The previous segment to the one being currently edited, default shortcut key **Num sub (-)** [keypad -].

Next - If you have moved from the end segment, Next takes you forward one segment, default shortcut key **Num plus (+)** [keypad +].

End - This takes you to the end track segment, default shortcut key **End**.

Flip Dynamic

Use it to swap the type of the dynamic segments you are currently editing e.g. from **Orthogonal XY** to **Orthogonal YX**. Note: this is not available when the segment mode is **Free** as this is single segment editing.

Before Flip Dynamic Segments

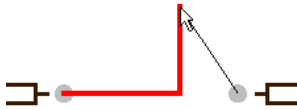

Adding orthogonal X segment followed by orthogonal Y segment.

After Flip Dynamic Segments

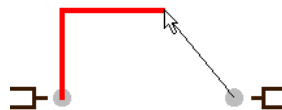

Now adding orthogonal Y segment followed by orthogonal X segment.

Flip works for each segment mode as follows:

Orthogonal

Before: X Line followed by Y line.

After: Y Line followed by X line.

Angled

Before: Orthogonal line followed by 45 degree line.

After: 45 degree line followed by orthogonal line.

Curved

Before: Orthogonal line followed by 90 degree curve.

After: 90 degree curve followed by orthogonal line.

Free - Not applicable.

And vice-versa.

Delete Segment this will delete the current segment back to the previous corner, shortcut key **Backspace**.

Online DRC (On-line Design Rule Checking)

Online DRC will constantly monitor the spacing limitations as set in the Technology data during manual track insertion or track edit, and will prevent spacing error violations being introduced.

To set the Online DRC, in insert track mode right click and select **Online DRC** from the menu.

Online DRC will operate either **Continuously**, meaning as the track is moved close to the unconnected item the system will prevent tracks from being placed, or **On Drop**, meaning the Online Design Rule Checking is only invoked as the track is finally connected.

To switch between Continuous and On Drop, select **Options** from the **Tools** menu and the **Online DRC** tab. Here you may select Continuous and/or On Drop.

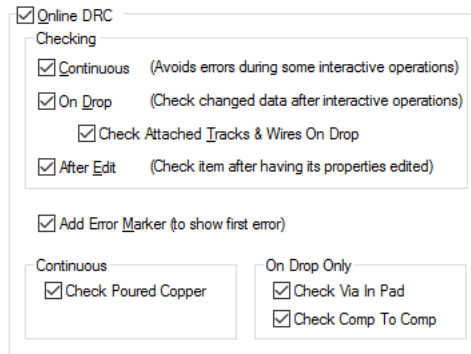

Pulsionix has the facility to **Display Clearances** around items during track edit mode or full Online Design Rule Checking to prevent design spacing errors being introduced.

To set **Display Clearances**, in insert track mode right click and select **Display Clearances** from the menu. During track insertion as you move close to an unconnected item a warning colour will appear around the item:

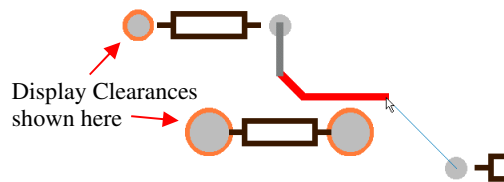

The orange outline (shown as the lighter ring around the pad) indicates the track is at the boundary point for placement of unconnected items.

If the track continues to be placed closer to the item then the colour will change to red (shown as the darker ring around the pad):

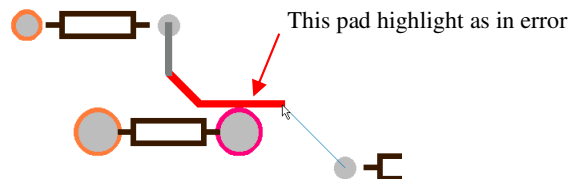

This clearly indicates that the track is too close to the item and the spacing limitations as defined in the Technology have been violated, (fortunately, with the use of bright colours on-screen, this is clearer).

Display Clearances

The **Display Clearances** parameters may be modified by selecting **Options** from the **Tools** menu, and select **Online DRC**. With **Show Design Rule Clearance** checked the parameter **On All Items** may be checked. This will show a continuous boundary around items in the design indicating the nearest that a track may be placed without causing a design rules error.

Within Set Distance is the minimum distance in units from the item before the warning boundary colour comes on. Alternatively, **Within Grid Steps** will cause the boundary colour to come based on the number of Grid steps around the item.

The default colour for nearest point is orange and violation of spacing rules in red. These colours may also be modified by going to the **Setup** menu and **Colours**. Under the **Highlights** tab are shown the colours for Clearances and Online DRC.

Push Mode

Track pushing is available on this menu. The settings for pushing are defined in the **Options** dialog and **Edit Track** page.

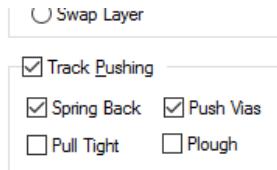

Change Grids

The track grid may be defined by selecting **Grids** from the **Setup** menu. Select **Tracks** from the drop down list, here the track grid size may be determined. During insert track mode, the track will snap to a grid point defined by this Track grid, or to Gridless or Working Grid if switched.

Changing to Gridless

At any point in the track insertion process you may switch to gridless routing by right mouse clicking and selecting **Change Grid** from the menu. You then have the choice to switch to **Gridless**, **Working Grid**, or back to the predefined **Track** grid.

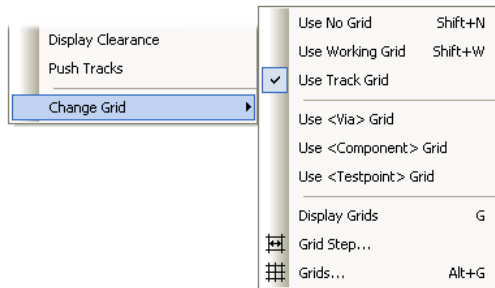

Options available by selecting a track segment

These features are available when a **track segment is selected** (selected and not being moved or edited).

The picture below shows the full context menu broken into two halves.

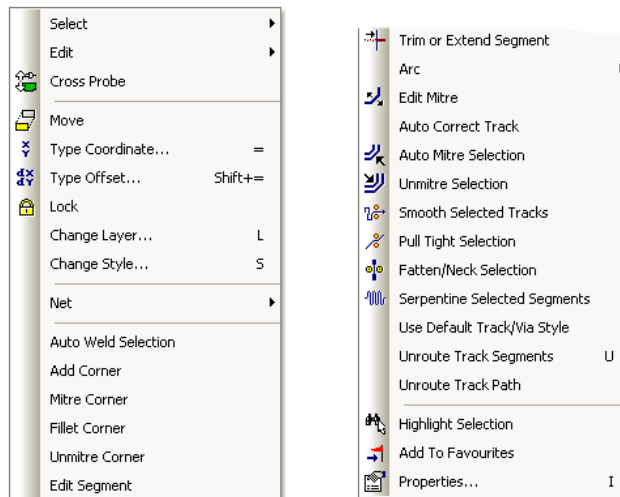

The **Select** option displays a number of **Selection** and **De-selection** options as well as **Select Next** and **Select Previous**. This will allow you to select the next item under the current cursor position, likewise, will allow you to select the **Previous** item. This is used when the cursor is above a number of connections in a tight area.

The **Edit** option opens to the standard **Cut**, **Copy**, **Paste** and **Duplicate** options.

Move will put you into Move mode. The segment can be moved until the mouse button is clicked, this will release the segment in its new position.

Lock/Unlock

This provides the ability to fix a track segment in place so that it cannot be moved. A lock status will also disable other functions being performed on it until Unlocked, e.g. **Move**, **Edit**, **Auto Routing**, **Optimise** or **Deleted** etc.

Net>> will reveal the options **Change Net**, **Split Net**, **Mark Net**, **Optimise Selected Nets**, **Unroute Selected Nets** and **Route Selected**. Split Net is discussed in more detail in the section below, *Managing PCB Nets*.

Edit Segment - once the track has been added you can double-click on it or use the **Edit Segment** mode to route it.

Arc>> there are several modes where the selected segment can be edit to create an arc. There are predefined options and options to allow the **Radius** or **Diameter** to be entered.

Remove From Net is used to remove any connections from the selected net.

Show Net Name this displays the net name on the selected net. The Style of the text used for the net name can be changed once displayed by selecting it and pressing the S key for Style.

Optimise Selected Nets will optimise the selected net only as a 'one-off' operation.

Unroute Selected Nets will unroute the selected net back to a connection.

Route Selected will automatically route the selected net. This option is only available if the Auto Route option is installed.

Unroute Track Segments

This will only unroute the current selected track segments. This option is a way of controlling the amount of unrouting or the selection of unrouting to be done.

Unroute Track Path

This will only unroute the current selected track path. Again, this option is a way of controlling the amount of unrouting or the selection of unrouting to be done.

Properties displays the characteristics of the Track, Net and Net Attribute. You can have any number of net **attributes** that can hold characteristics for other purposes, e.g. routing, simulation or Guard Spacings for additional spacing clearances on that net.

Options available by Editing a track segment

There are some options only available during the Editing of existing tracks.

Disconnect End Track this option will enable you to remove the track from one electrical item and connect it to another. If this is the only connection point to that item, the item will become isolate from the net.

Reverse Editing Direction this is used to swap the direction of the segment you are currently editing from the shape.

Before Reverse Direction

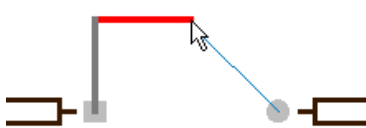

After Reverse Direction

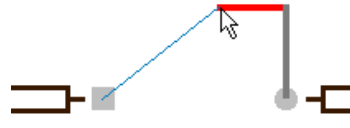

Editing from the square pad to the round pad. Now editing from the opposite direction

Miscellaneous items associated with editing tracks

When a item shows a butterfly connection marker this is an indicator that that item can only be connected to a power plane (that uses the same net name) using a via.

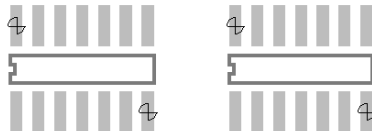

Typically a surface mounted pad, as shown above, will contain these markers if a connection to the power plane is required. These would normally be routed using 'stub' routes.

Adding Stub Routes

Stub routes are small track segments that stem out of a surface mounted pad, although they can emanate from any electrical item. Generally, they are used to connect to a power plane layer but can also be used on dense designs where a short track is required to exit the surface mount pad to make more space for other tracks and vias.

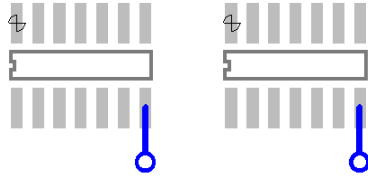

The image above illustrates how short track segments are extended from the surface mount pads and connect directly to a via that in-turn connects to the power plane (assuming that the net name and power plane net name are the same).

► To add stub routes for connection to a power plane

If you have lots of stub routes to do then change the default setting of the **Track Editing Double Click Operation** option under the **Options** dialog, **Edit Track**. You can make the default double click setting to be **Finish On Via**.

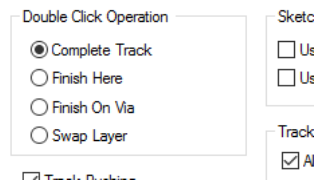

1. Edit the connection from the surface mount pad that you wish to create into a stub route. You can also insert a track from the pad to start, if using this method.
2. Drag the mouse out of the pad to draw a small track segment, click once to confirm the segment or add a corner.

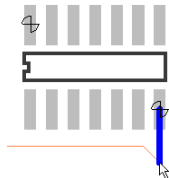

3. Double-click the mouse to add a via.

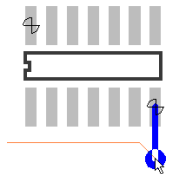

4. You are exited from this option and the stub with via is added.

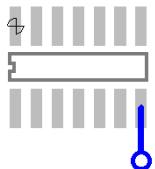

► To add stub routes to connect to other layers

1. **Edit the connection** from the surface mount pad that you wish to create into a stub route. You can also **Insert a track** from the pad to start, if using this method.
2. Drag the mouse out of the pad to draw a small track segment, click once to confirm the segment or add a corner.
3. Right click and select **Change Layer**, or click <L> to Change Layer.
4. Select the required layer and click **OK** or <Enter> to accept the default layer change, this layer will be your default swap layer.
5. You can now continue routing on the new layer.

Adding additional vias to tracks

Once the track has been added you can add additional vias to it without changing the layer for the track segment. This could be used if a power track also requires multiple entry points, using vias, to a power plane even though it is routed fully. This method can also be used for copper areas or suchlike but will be discussed in context in the section on *Inserting Copper*.

► To add additional vias to tracks

1. From the **Insert** menu select **Insert Via**. This will present you with a free standing via that can be placed on the track.
2. The Via can be positioned anywhere until released. Once released it is truly connected to the track and will move if the track is moved.

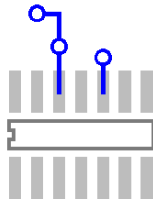

Changing via sizes and via spans

Once a via has been added to the design its style or layer span can be changed to something other than that that is specified in the Net Class.

Both the style and layer span of the via can be changed using through the **Properties** dialog.

► To change the via style and layer span

1. Select the via or any number of vias.
2. Select **Properties** from the context menu, alternatively select the via and press <I> (for Properties) and choose the **Via** tab.

Position: Locked

Angle:

Layer Span:

Type:

Allow Automatic Changes:

Delete if not Routed Reduce Layer Span Allow Suppress Lands

Via Style:

Name:

Width: Shape:

Length: Drill: Id:

Plated

Power Plane Connection:

Attached Tracks: Highest Layer: Lowest Layer:

Attached on Layers:

The **Layer Span** list box is used to choose between all of the suitable layer spans defined in the Technology dialog. A layer span is available in the list if it includes the connected span of the selected via.

Allow Automatic Changes - Normally, just as vias are automatically added by layer changes, they can be deleted by swapping layers of attached tracks back so that they are no longer required. You can stop this deletion from happening by unchecking the **Delete If Not Routed** switch. This will lock the via from automatic deletion.

Similarly, if you have multiple layer spans defined in your technology, vias will have their layer span automatically reduced if possible to the 'best fit' span. This again will happen with a track layer change. To stop this from happening uncheck the **Reduce Layer Span** switch.

When enabled, **Allow Suppress Lands** will allow a land to be suppressed when appropriate (i.e. a **Suppress Land Rule** has been defined and this via is not connected on that layer). Uncheck this option to not allow any land suppression on this via.

The **Via Style** is used if you want to change pad style of the Via. You can change it to another predefined Pad Style by selecting one from the **Name** drop down list.

You can alternatively change it to a new **Pad Style** by defining alternative parameters. This can be done by changing the **Width** and or **Length**, or the **Drill** size, or by changing the **Shape** drop down list. If there is no Pad Style to match these parameters then a new Pad Style will be added with the name that you want to call it.

Track Breakouts (Fanouts)

Breakouts (fanouts as they also called) are used to create predefined or potential track patterns for use where the pads are restricted on a Footprint. Typically these patterns would be used where routing is very dense on a surface mounted device, and where ‘human’ intervention is the most sensible option. The breakout patterns are more suited to designs where automatic routing will take place. They often give the router more solutions to what may appear a ‘fixed’ option. For instance on a surface mounted QFP where all the pads are on one side of the design, by using breakouts and breakout vias, the pins then become accessible to all layers if the vias are defined as <Through-Hole>.

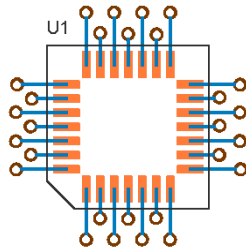

Breakouts can be used on SMD and through-hole pads.

In Pulsonix, breakouts are generated and stored in the Footprint definition. This means that the definition always knows about the breakout and can apply or reapply the original breakout pattern at any time.

The process of using breakouts

The ‘flow’ for using breakouts is as follows:

- Create the breakout pattern in the footprint using the Footprint editor and save it.
- In the PCB design the breakout guide will be displayed.
- Either edit a track/connection to the breakout that will be a legal finishing point and will be shown as node point on the net. The breakout automatically gets converted to a track, or;
- Select the breakout or Component and from the context menu select Hide Breakout or Convert Breakout To Track.

Breakouts in the Design

Once a Footprint is used in a design, the breakout is a self-contained item, at this point it is not a track or via but a ‘guide’ to the final track pattern when connected.

For breakouts to work the pads to which they are attached must be on a net. If a single (or multiple) breakout is required on an unconnected pad then the pad must have a net name. A single pin net name can be assigned in the Schematic design so that the Synchronise Designs option doesn’t rip out any single pin net in the PCB.

To differentiate breakouts from ‘normal’ vias or tracks they have their own colour slots in the **Colours** dialog. Under the **Vias** tab you have **Breakout** (vias) as a Layer Span, and under the **Track** tab, you have **Comp Breakouts**. By default in the supplied Technology files these items have their own colours so they are visible when tracks and vias are used in a design.

To use breakouts that exist on Footprints you have a number of options, all available on the context menu for selected Footprint entities: on a selected Component(s), on individual pads on a Component that have breakouts and on the whole design (but the design must have breakouts on at least one Component): **Hide Breakouts**, **Show Breakouts**, **Convert Breakouts To Tracks**. .

Hide and **Show Breakout** will allow the breakout to be hidden or shown on a Component. If the breakout has already been converted to a track it can still be shown even though it may be redundant.

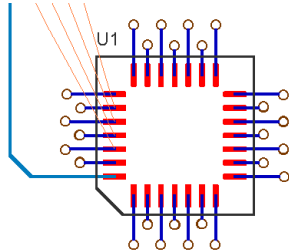

The example above shows a track that has been connected to a breakout. The breakout has been converted to a track and the breakout via removed. Automatically the breakout is switched to 'hidden'. If you need to see the breakout pattern, for confirmation purposes of its original direction for example, you can then select the pad and from the context menu select **Show Breakout**.

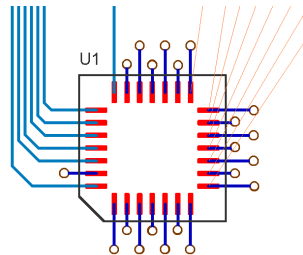

The example above shows one side of the IC routed to the pads without using the breakouts. One pad has no connection and still shows the breakout.

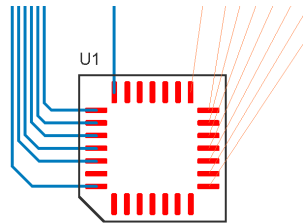

The example above shows the whole Component with the breakouts hidden. Connections can still be seen to the Component, as these must still be routed.

If converted to a track or if the breakout is left unrouted, you can select **Remove Redundant Breakout Tracks** to remove them.

If a track is completely unrouted thus also removing the breakout path, the breakout can be 'regenerated' by right clicking on the pad and selecting **Show Breakouts**.

While editing a connection that is attached to a pad with a visible breakout, if a breakout is at the end of the connection you have picked, an initial track will be created from the breakout.

If a breakout is at the other end of the connection, the connection will be re-drawn to end at the end of the breakout. Using **Complete As Track** option in this situation will use the breakout path for its completed track.

Also, double click in select mode on a visible breakout in a PCB design will add a new track that uses the breakout path from the selected point back to its pad. You will then be in **Insert Track** mode to complete the track.

Plotting breakouts

You cannot output breakouts directly through the CAM Plot option, they must be converted to tracks and vias first. Remember, Breakouts are transient objects in the design to highlight possible track paths when applied.

Create Breakout Pattern (BGA Fanout) in PCB

Within the PCB design, there is also a command available in the **Tools** menu called **Create Breakout Pattern**. This is used to create breakout (fanout) patterns within the design without the need to create a Breakout pattern in the footprint first. To use the option, select a component or a pad on the component and use the **Create Breakout Pattern** option on the context menu. A dialog is displayed from which to choose the pattern required:

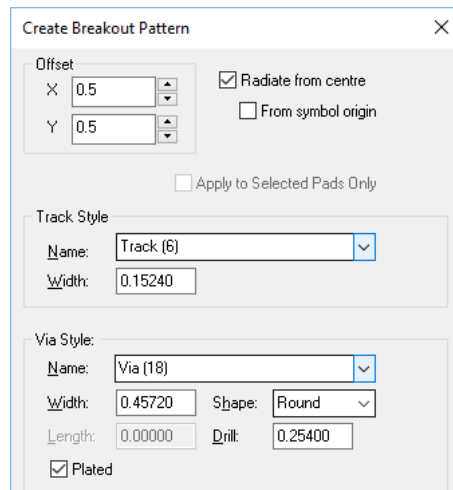

The dialog will only create a pattern for components that have at least one pad that is on a net and does not already have a routed connection. Applying a pattern will not delete or edit any existing tracks that are attached to pads on the component (no changes will be made to these pads).

When applying a pattern, a DRC check will be performed. Selecting **No** will remove the inserted pattern. You cannot use this option if the selected component in your PCB design already has breakouts.

Using the AutoDim option

The **Dim Other Layers** option is only relevant to layered designs in PCB, and as a consequence of using Fast Redraw, making it feasible to draw the layers other than the current layer in dimmed colours. This makes it much easier to see obstacles on the current layer, but at the same time, not losing sight of items on other layers. Selecting the **All Dim in One Colour** option means all the other layers dimmed are one colour and not their layer-dimmed colours.

To switch this option on, select the **Dim Other Layers** check box from the **Options** dialog and **Display** tab. You must also have switched on, **Fast Redraw** and **Draw Current Layer On Top** so that **Dim Other Layers** is available.

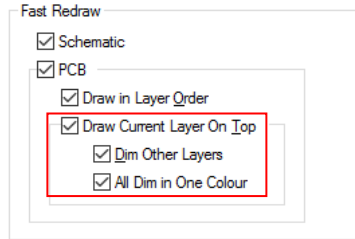

Unrouting Tracks

You may sometimes have a requirement to unroute part or all of the design. Unrouting is the process of removing tracks back to their connection or net paths. Pulsonix contains a number of options that allow varying levels of unroute to be accomplished:

The **Unroute Nets** option is available through the **Tools** menu. The three options available control the amount of unrouting allowed.

All Nets is used to unroute all nets in the design regardless of any nets already selected.

Browse displays the browse dialog for a net selection. Individual nets can be selected by using the pick and Ctrl-Shift pick methods.

Selected Nets will enable you to choose the tracks to be unrouted from the design. You can choose single or multiple tracks or individual track segments.

*The **Delete** key from the keyboard can also be used to unroute tracks but is not recommended.*

The **Unroute Track Segment** and **Unroute Track Path** options are also available from the context menu when a net is selected.

Using Shapes and Cutouts

Shapes

Shapes are used in Pulsonix for a number of design items. For ease of use and clarity, the shape types have been separated into their own options. This makes the selection for the tool and the characteristics of the shape easier to understand when adding to the design.

Shape Types

You can add shapes for:

- Board
- Copper
- Documentation (shapes)
- Areas
- Copper Pouring (Templates)

Shape Properties

For each of the shapes there are properties that give it its characteristics. All shapes can be Open or Closed and Filled or Unfilled (unless shown otherwise below) in addition to unique properties:

Board – Used on <Through Board> layers (or specific layers or layer spans if you have the Advanced Technology option), cannot be an Open shape, Filled or Hatched.

Copper – Used on electrical layers, can be Hatched and can have a Net Name.

Shape – Used on non-electrical layers, can be Hatched.

Area – Used on any electrical layer and layers of <Through Board>, <Top Side> & <Bottom Side>, (or specific layers or layer spans if you have the Advanced Technology option), cannot be an Open shape, can be Hatched, also has Keep In/Keep Out characteristics for Copper, Tracks, Vias, Microvias, Testpoints and components.

Template – Used on electrical layers, cannot be an Open shape, can be Hatched, can have a Net Name, used for pouring copper into.

Splines, Ellipse, Waves – used for creating special shapes.

All shapes (except Open shapes) can also have a cutouts inserted into them. Cutouts are discussed in more detail later on in this section.

The Shapes Available

There are different types of shapes available and others can be made from these:

- Polygon
- Rectangle and Square
- Circle
- Triangle
- (Straight) Line
- Spline
- Ellipse
- Wave

Each shape is access from the Insert menu under their respective shape types. The example dialog below shows the **Insert Copper shape** sub-menu but not all *Insert Shape* dialogs are the same format:

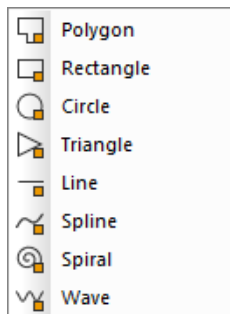

From these three shape types you can create any shape required in the design, including straight lines using Insert Line or an Open Polygon shape. Each of the different types of Shapes is also available as shortcut commands and as buttons for the toolbar. A basic shape toolbar containing a selection of the most used tools is supplied by default although this can be modified to suite your requirements.

Shape Styles

Shape styles are defined on the **Design Settings** dialog under **Defaults**.

For each shape type (Area, Board, Copper, Doc Shape and Template) its default status as added to the design can be determined using the shape selection. The dialog above shows the Copper defaults. Copper is the most complete shape in terms of what can be predefined with the other shapes using some of these choices under their own default.

Each shapes default **Layer** can be defined. For each of the shape types the layers allowed will be relative to the type of shape being added, e.g. Board can only be added to <Through Board> layers, Doc Shape only added to Documentation layers etc.

When the shape is added, the default Style of the shape added can be selected using **Line Style**. This can be changed during or after the shape is added.

Some shapes can be an **Open** shape. This means that the **Closed** button would not be checked. If the shape cannot be Open, the Closed button will be greyed out and checked.

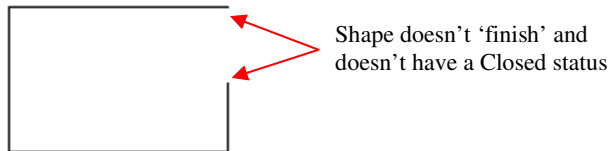

The example above shows an **Open** shape where the start and end point don't coincide.

Note: Having a start and end position coincident isn't enough to make this a closed shape. The shape must also have a 'Closed' status as well.

If the shape was **Closed** it would look like this where the outline would be one continuous shape:



If a shape is defined as **Closed**, it can also be **Filled** and **Hatched**, but it cannot be Open and Filled/Hatched. Likewise, a shape cannot be Unfilled and Hatched.

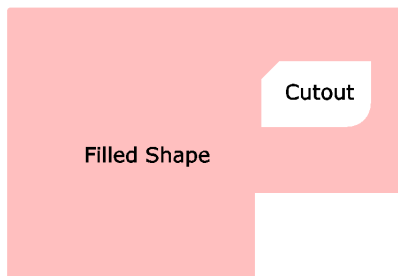

A Filled shape could also have any number of cutouts added to it. Cutouts are discussed further on in this section.

Solid or **Hatched** Filling might be used give a shape more emphasis or in the case of Copper for specific electrical purposes.

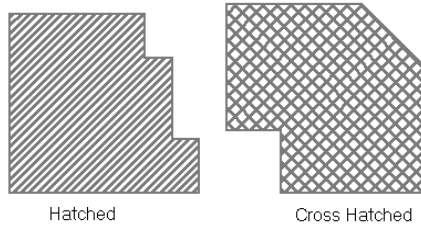

The style of the Hatching can be defined using styles setup in the **Technology** dialog under **Hatch Style**. The style can be **Hatched** or **Cross Hatched**.

Inserting Shapes

► To insert a shape

1. On the **Insert** menu, select **Insert Shape** then select the shape as required. The shape may then be created in the design.
2. For a **Rectangle** or **Circle** drag the mouse to create the required size. For a Polygon, single click to start, single click at each corner point required and double click to finish.
3. If Inserting a **Rectangle** but a **Square** is required, right click and select **Square**.

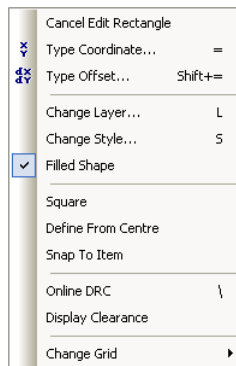

4. During **Insert Rectangle** and **Circle**, you can use the **Define From Centre** option on the context menu to drag the shape from the centre rather than the edge.
5. During **Insert Triangle** you can create a triangle in a number of modes; **Free Movement** allows uneven lengths of sides, the **Equilateral Triangle** mode allows all sides to be equalised. After the first corner has been added, the context menu displays the following options:

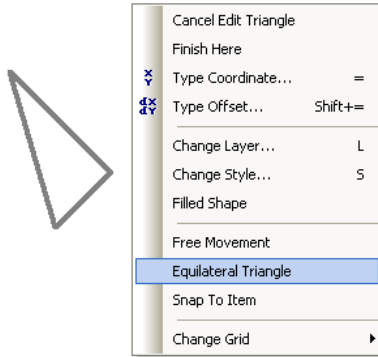

6. Using this mode you can create a proper triangle without calculating the angles and side lengths to make the correctly formed triangle. After the first side has been added, **Orthogonal** mode snaps the moving segment side to a 90 degree triangle or to the centre to create two other equal sides of the triangle with a 45 degree angle. With the triangle corner dynamic, a right click will enable the triangle to be snapped into the Equilateral Triangle mode to fix this corner.
7. At any time you can right click and select an option from the menu. Each of these is discussed below.

Shapes and the Technology dialog

The **Technology** dialog is used to initially create the styles used for the shapes and their defaults.

Layers, the **Layer Class** and **Layer Type** determine which layer the shape will be used on, depending on the layer type is selected: Construction, Electrical, Documentation and Non-Electrical. Only particular shape types will be allowed on these layers when added to the design.

Line Styles defines the overall outline width of the shape and the thickness of the hatch lines when used in Hatch styles. The Line Style entry contains a single thickness value in the current design units and a style name for the line.

You can also make line styles dotted and dashed and various combinations as well as solid. This applies to doc shapes and unconnected copper. There are various dot and dash line styles available - dotted, dashed, dot/dash, and user defined dot/dash spacing. Each of the standard line styles is available from a drop down list.

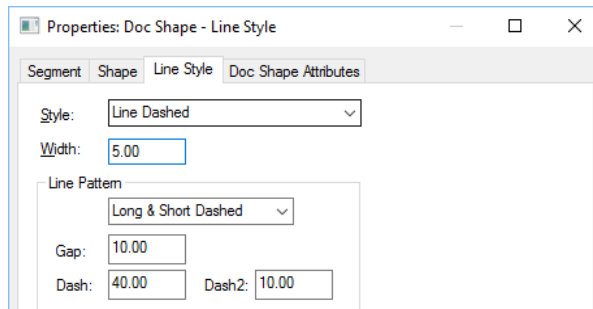

The diagram below shows how the entries in the dialog relate to the actual dashes and gaps produced in the design.



Hatch Styles will define the Hatch style and whether it is Hatched or Cross-Hatched. The line style used to create Hatch or Cross-Hatch will be the line style used to define the shape outline.

	Name	Angle	Coverage (%)	Cross Hatched	Width Percent	Offset Percent
	Cross Hatched	45.0	50	<input checked="" type="checkbox"/>	100.00	0.00
	Hatched	45.0	50	<input type="checkbox"/>	100.00	0.00
	Hatchcode 90/90	90.0	10	<input checked="" type="checkbox"/>	100.00	0.00
	FigureHatching	90.0	16	<input checked="" type="checkbox"/>	100.00	0.00
	LowCoverage	45.0	50	<input checked="" type="checkbox"/>	50.00	20.00

The entry defines the **Name** of the Hatch Style, the Hatch **Angle** in degrees, the **Coverage %** meaning the percentage of copper that will be in the copper filled area using this style, and whether the style is Hatch or Cross Hatched.

Note: By defining the Coverage % and Width %, this will enable you to more accurately determine how much copper is left on the finished board after etching.

Shape Selection and Move

Individual shape segments can be selected simply by selecting them. If you wish to select the whole shape however, you must select the shape while pressing the **Shift** key. This will then select the complete shape ready for moving or editing.

If you wish to Move the complete shape, you should select the shape while holding the **Shift** key. The shape will now be dynamic on the end of the cursor ready for positioning.

Modifying Shapes

After inserting a shape it may be edited simply by clicking on the segment. If the shape is a rectangle or polygon, you can drag the segment to the new position. If the shape is a circle, then you cannot drag the shape to edit it, dragging a circle will only move it. Instead, double-click the circle outline and drag it to change its shape.

► To add an arc to a segment

1. To add an arc into a straight line segment, select the segment and right click. From the context menu select the **Arc** option.

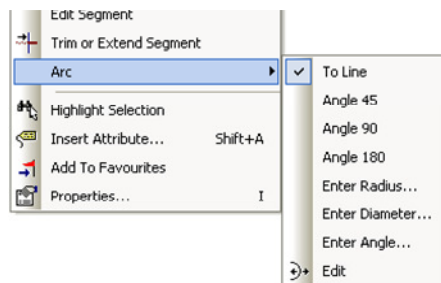

2. From the menu, select the option required to create the arc.

► To edit the end of a straight line segment

1. If you wish to edit the end of a straight line segment to increase its length or add additional corners for example, you can still double-click on the line but must select its end point.



2. If you select the end point this will be indicated with a small circle. From this you can move the end segment by dragging it.



While editing the segment you can use options available from the context menu.

Changing the Style of the shape

At any time during the addition of the shape or after it has been added, the style used can be changed. This means that the Line Style, Closed/Open status, Filled/Unfilled style and its Hatch/Cross-Hatch style can be changed. In addition to these styles, the shapes Rotation, Mirror status Lock status and Layer can all be changed.

Rotation is carried out about the shapes Start/End origin using one step rotation.

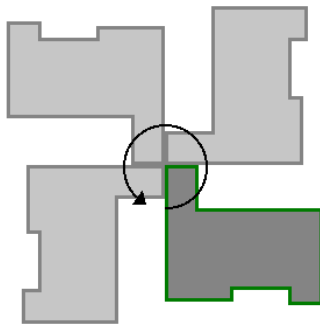

Mirror is carried out about the Start/End point origin axis.

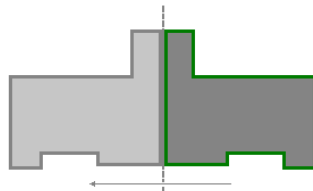

When a whole shape is selected (using Shift-pick to select it), pick an option from the context menu. The menu below is displayed when a documentation shape is selected:

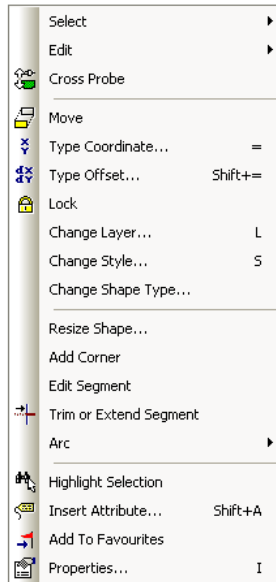

The **Move** option can be used as an alternative to using **Shift** select on the shape.

Edit Segment will have the same effect as double-clicking on the shape.

If the line is edited rather than selected, slightly different options are available but in the most they are the same. You get **Closed Shape** (for an open shape or line segment), **Editing Options** and **Change Segments**.

As well as selecting options from the menu directly, the **Properties** option will display a dialog from where you can change all aspects for the shape selected.

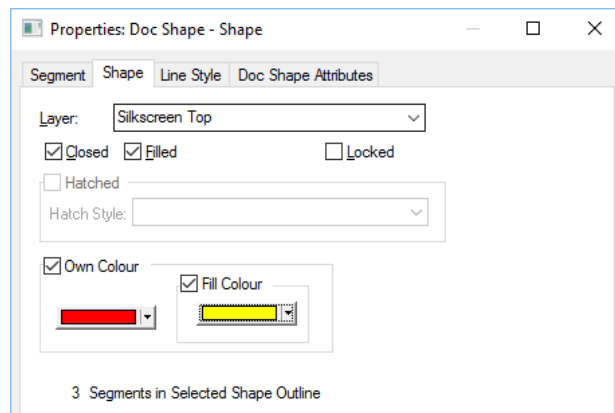

Some shape types also have their **Own Colour** selection to help more easily identify specific shape items. Use this carefully as it may well lead to confusion if selected over the standard colours set in the **Colours** dialog.

► To change the line style

1. Select the line or shape. You can right click and select **Change Style** from the menu (keyboard shortcut **S**), or right click and use **Properties** (shortcut **I**).
2. When the **Change Style** dialog is displayed you can select a Style from the drop down list box or type in the width required.

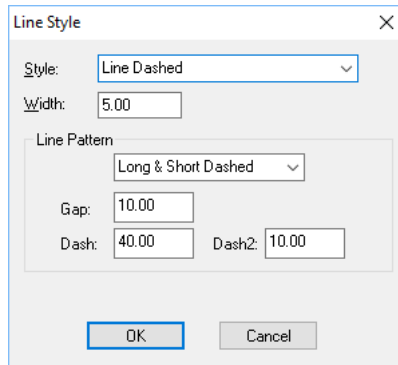

3. If you type in the width required, when you press **OK** you will be asked to confirm the new default style name if it doesn't already exist in the Technology.
4. If changing the style of the line to a thicker width, be aware that the thickness is added around the centre line of the shape, effectively making the shape bigger. If changed on electrical layers, you should run a **Design Rules Check** to ensure that the shape still has enough space around it.

► To change the shape layer

1. Select the line or shape. You can right click and select **Change Layer** from the context menu (keyboard shortcut **<L>**), or right click and use **Properties**.
2. When the **Change Layer** dialog is displayed you can select a new layer from the drop down list box.

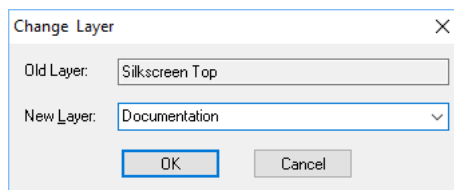

3. Press **OK** to confirm the layer change.
4. You should run a Design Rules Check to ensure that by changing the layer, you have not created any errors.

Design Rules Checking Shapes

Shapes placed on electrical layers have their own Spacing rules defined in the Technology dialog and should be Design Rules Checked along with all other electrical items on these layers. Shapes on non-electrical layers are ignored. This can be done as part of your **Design Rules Checking** process.

Copying and Growing Shapes

In Pulsonix, shapes can be duplicated, copied to another shape type, or duplicated and grown/reduced. Detail has been provided below on how to perform these tasks.

Duplication of shapes may be required the same shape exists multiple times, e.g. corner cropping markers defined using copper shapes on the four corners of a board.

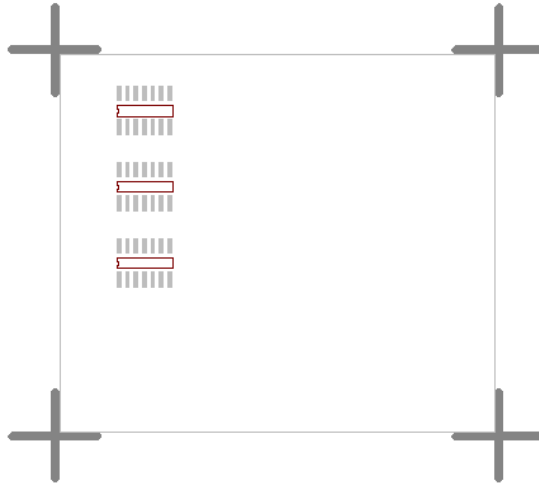

Duplicating a shape

To duplicate a shape is straightforward. Any shape can be copied in Pulsonix and pasted back into the design. There is also a **Duplicate** option that does the **Copy/Paste** for you. Where Duplicate is described below, you can also substitute this for a **Copy** (<Ctrl-C>) and **Paste** (<Ctrl-V>), but one key sequence to **Duplicate** (<Ctrl-D>) is quicker.

► To duplicate a shape

1. **Shift click** to select all of the shape to be copied. <Ctrl-D> to duplicate.
2. The copied shape will appear on top of the existing shape and on the cursor ready for positioning as required.
3. While the shape is on the end of the cursor, right click to obtain the context menu if you wish to change its properties.

Copying and changing the shape type

If you wish to copy an existing shape but then change its shape type you can use another method.

► To duplicate a shape

1. **Shift click** to select all of the shape to be copied. Press <Ctrl-D> to duplicate.
2. Select **Insert Shape** from the **Insert** menu and press <Ctrl-V> to Paste.
3. The copied shape will appear on the cursor ready for positioning as required.

Because you have put a copy of the shape into the clipboard, once you then select an **Insert Shape** operation, this shape (but only the shape outline) will be pasted into the design taking on the new shape's default properties.

For example, you could copy a **Board Outline** shape, and paste it back into the design as an Area shape. Moving on from this technique, you could also paste it back into the design and shrink or grow the shape so that it is an exact copy, a different shape type and smaller!

Resizing shapes

Pulsonix has the ability to grow and shrink shapes. Provided the whole shape is selected the **Resize Shape** option can be used (this option is also used to shrink shapes using negative numbers [-20]).

► To resize a shape

1. **Shift click** to select the whole shape.
2. Right click and select **Resize** from the menu.

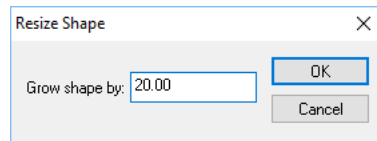

3. From the **Grow Shape** dialog, type in the size to grow the shape by. A negative number will reduce the item in size (e.g. -20).

The **Resize** option is available at any time when a whole shape is being added to the design, Pasted, Duplicated or Moved.

Below is an example of an instance where an exact replica of the board outline might be required but with additional manufacturing clearances allowing for board cropping.

► To create a template within the board outline

The description below combines some of the techniques described previously as a working example for creating a **Copper Pour Template** within the board outline. It will leave a consistent gap from the copper to the edge of the board boundary even when the board profile is an odd shape.

The diagram below shows the original board outline that was started with:

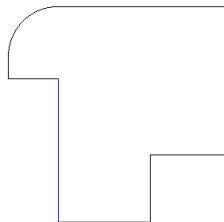

1. **Shift click** on the board outline to select the whole shape.
2. Press <Ctrl-C> to copy.
3. Select **Insert Template** from the **Insert** menu
4. Press <Ctrl-V> to Paste. The board outline will be copied as a **Template**.
5. From the context menu, select **Resize**. By using a minus sign before the size, the Template will reduce in size consistently leaving a boundary gap to the required distance.
6. Position the Template and release.

The example below shows how it would look when reduced in size to create a boundary gap.

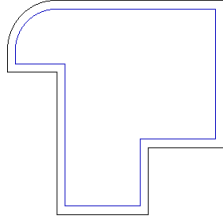

The **Properties** of the **Template** would be as defined in the **Options** dialog for **Template Defaults**.

Using Shapes in Footprints

Shapes can also be used when creating Footprints in the library. Footprints can contain Copper, Shapes, Areas and Cutouts. More details about Footprints can be found in the Chapter on *Library Management Tools*.

Areas

Area shapes can be added to your design or to a Footprint definition in the library. An area added to the design could be used for example for **Keep In** or **Out** of items such as **Copper**, **Copper Pour**, **Drill**, **Tracks**, **Vias** or **Components**. You could also use an area to act as a **Board Cutout** within an existing **Board** outline. If using the Advanced Technology option, this could also be used across a defined **Layer Span** to act as a **Cavity** within a Board stack.

Properties: Area - Area

Segment Shape Line Style Area Area Attributes

Name: VH Area Design Extents

Keep In/Out

Tracks: Unrestricted Copper Keep Out Drill Keep Out

Vias: Unrestricted Micro-vias: Unrestricted

Testpoints: Unrestricted Mount Hole: Unrestricted

Component Pads: Unrestricted

Components: Unrestricted If Higher Than:

Power Planes

Copper Pour Avoid Board Cutout

Power Plane Avoid Plated Cutout

Alternative Thermal Gap

Override Within Area

Use in Area Based Styles, Spacings and Rules

Use in Footprint Rules

Rules:

Another use of an Area is for defining a specific region for **overriding Spacing rules and Net Class Rules**. You may use this for example under BGA to provide you with tighter Via to Pad spacing rules where small vias are used on the end of short stub route breakouts.

Footprint Areas

When using an Area within a Footprint in the Library, you have additional parameters that you can specify.

These define the area use within the footprint; **Placement Clearance**, **Body** and **Model Placement**.

An area nominated to be a **Placement Clearance** area, defines the area required around the component. For example, you may require a space along the sides of the component to allow for the jaws of a placement machine. The body area of another component cannot overlap with this Clearance area. Clearance areas may overlap as long as the body areas are legal.

The **Body** is the actual physical body of the component and is used to determine if something (such as a testpoint) is underneath the component. Check this box to specify the area as a **Body**. This area (or areas) is used in the automatic placement of components and for checking the component to component spacing. The rules are applied such that neither a body, nor a Placement Clearance area, of another component may overlap a body. Also, Body areas must be at least the Component to Component spacing apart. If no Body or Clearance areas are defined, the bounding box of any documentation (e.g. silkscreen) shapes is used.

Use the **Area Height** box to specify the height of the component body. This height will be used in checking against component keep out areas. Note: if no units are added to the end of the height value, it will use the units of the design when used.

An area marked as a **Model Placement** area is used for aligning STEP models when producing **STEP output** or displaying a STEP Preview. The relative height and width of the area is used to determine the correct orientation of the STEP model with respect to the overall height and width of the footprint.

The image shows a configuration dialog for footprint areas. At the top, there are dropdown menus for 'Component rules' (set to 'unrestricted') and 'Components' (set to 'Unrestricted'), along with an 'If Higher Than:' field and a 'Set All Keep Out' button. Below this are sections for 'Power Planes' (with checkboxes for 'Copper Pour Avoid', 'Power Plane Avoid', and 'Alternative Thermal Gap'), 'Board Cutout' (with checkboxes for 'Board Cutout' and 'Plated Cutout'), and 'Override Within Area' (with checkboxes for 'Use in Area Based Styles, Spacings and Rules' and 'Use in Footprint Rules'). The bottom section, titled 'Component', is highlighted with a red border and contains three checkboxes: 'Placement Clearance' (checked), 'Body' (checked), and 'Model Placement' (unchecked). To the right of these checkboxes is a 'Body Height:' field with the value '1.4mm'.

Merging Shapes

Merge Existing Shapes

You can merge a set of selected shapes using the **Merge Shapes** command (also see **Insert Merge** below). Shapes must be **Closed** in order for them to be accepted for merging.

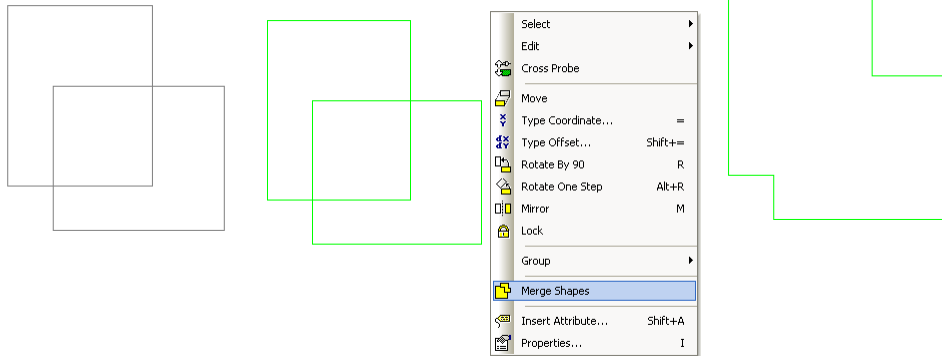

Add two shapes to the design.

Select both shapes and select Merge Shapes from the context menu.

The two shapes are merged as one.

Insert Cutout

Adding a cutout removes the cutout shape from the outline if they intersect.



Once the shape is drawn, select Insert Cutout. Select the shape. Draw the cutout starting outside the shape. Draw 'across' the initial shape and finish.

The resulting shape is now minus the shape 'cutout'.

Insert Merge

A set of commands allows you to add a new shape to be merged with an existing shape. The function is similar to **Add Cutout**, except the shape is added rather than removed.

Cutouts

Cutouts are used within a shape to define an area or void within that shape. Other options within Pulsonix understand the difference between shapes and cutout shapes within them, this is particularly important when a router needs to avoid this cutout and not route across it for example. Cutouts also know the shape they belong to and will move to with the shape if the shape is moved.

The rules for using Cutouts

Cutouts can be used on all electrical and documentation shapes provided they are a **Closed** shape. The cutout shape can protrude outside the shape in which it exists but will become a ‘removed’ shape not a cutout, like in the example below.

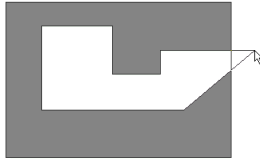

► To insert a cutout

1. On the **Insert** menu, click **Insert Cutout**
2. Click the shape for which to add the cutout.
3. The shape will highlight and the required shape may then be created within the ‘host’ shape.
4. If you attempt to release the shape in an illegal position, a warning dialog will be displayed and the shape will not be released.

Board Cutouts

Board Cutouts

A **Board Cutout** is available to be used to add a separate cutout within a board (using the **Insert Cutout** option). This will be treated differently; it cannot be routed over (with a DRC error), it cannot have copper poured over it and cannot have components placed in it.

This style of cutouts uses the same plate/not plated status and is detailed to the manufacturer when he receives manufacturing notes.

The display of these **Board Cutouts** is defined in the **Layer Class** page of the **Technology** dialog.

Name:

Used:

Layer Type: Essential For Manufacture

Pad Oversize: <input type="text" value="0.0"/> <input checked="" type="radio"/> Absolute Size <input type="radio"/> Percent of Pad Size	Pad Types: <input type="checkbox"/> Component Pads <input type="checkbox"/> Doc Symbol Pads <input type="checkbox"/> Bgnd Pads <input type="checkbox"/> Free Pads <input type="checkbox"/> Mounting Holes <input type="checkbox"/> Comp Mount Holes <input type="checkbox"/> Vias <input type="checkbox"/> Micro-vias	Pad Condition: <input checked="" type="checkbox"/> Surface Mount Through Hole: <input checked="" type="checkbox"/> Plated <input checked="" type="checkbox"/> Non Plated <input type="checkbox"/> Only If Testpoint <input type="checkbox"/> Exception Only	Areas Visible Component <input checked="" type="checkbox"/> Body <input checked="" type="checkbox"/> Clearance <input checked="" type="checkbox"/> Others <input checked="" type="checkbox"/> Design Board Cutouts <input checked="" type="checkbox"/> Unplated <input checked="" type="checkbox"/> Plated	Break Shapes <input type="checkbox"/> Break Around Pad <input type="checkbox"/> Break Around Text <input type="checkbox"/> Break Comp Shapes At Board Gap: <input type="text" value="0.0"/>	Layer Mask Min Mask Width: <input type="text" value="0.0"/> Min Mask To Track: <input type="text" value="0.0"/>
Min Undersized Pad: <input type="text" value="0.0"/> <input checked="" type="checkbox"/> Board Visible <input type="checkbox"/> Merge Cutouts		Draw/Plot Appearance <input checked="" type="checkbox"/> Pad Land <input type="checkbox"/> Drill Hole		Variant Components <input type="checkbox"/> Items Visible In All Variants <input type="checkbox"/> Use Variant Style	Panel <input type="checkbox"/> Check Items Outside Board <input checked="" type="checkbox"/> Draw Shapes in Panel Design

Board Cutout Areas

You also have **Board Cutout Areas** which can be added as required, these are added using **Insert Area**. This is particularly useful if the cutout in a board needs to be processed in a different manner, such as plated or punched or routed. This area type is also available in **Footprints** for component based specific cutouts for example. A Board Cutout can be defined as **Plated** or left unchecked, as **not plated**.

Once added to the design, **Properties** of an **Area** can be modified as **Board Cutout** and then **Plated** or **not Plated** (by leaving it unchecked).

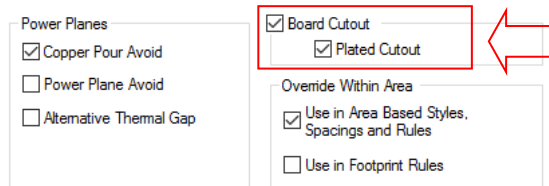

Inserting Copper

The copper facility in Pulsonix allows areas or shapes to be added to electrical layers that can subsequently appear on the final plots, and hence PCBs.

The **Insert Copper** option is used to add these copper items regardless of their shape. This type of shape might be used for cropping markers on the edge of the board or specific sized shapes. If the shape is required on a non-electrical layer the **Insert Shape** option should be used.

*Note: Insert Copper is not Copper Pour and does not automatically create voids around Component pads, tracks, etc. For this type of copper, you should use the **Copper Pour** option. Refer to the next section **Templates and Copper Pour**.*

Copper shapes can be defined as Open or Closed and Filled or Unfilled, used on any electrical layers, can be Hatched or Cross-Hatched and can have a Net Name.

The use of *Shapes and Cutouts* has been described extensively in the previous section. This section details specifics of Copper shapes.

Setting up the Technology dialog

Copper line styles are defined in the **Technology** dialog under **Line Styles**.

	Name	Width	Line Pattern
Y	<Thermal Relief Spokes>	5.00	Solid
	Area	1.00	Solid
	Board	12.00	Solid
Y	Centre Line 1.00	1.00	Solid
Y	Component Outlines	8.00	Solid
Y	Component Outlines Small	6.00	Solid
	Copper	25.00	Solid
Y	Draft	2.00	Solid
	Line Dashed	5.00	Long & Short Dashed
Y	LineStyle 1.0	1.00	Solid
Y	LineStyle 3.0	3.00	Solid
	LineStyle 4.0	4.00	Solid
Y	LineStyle 5.0	5.00	Solid
Y	LineStyle 6.0	6.00	Solid
Y	LineStyle 8.0	8.00	Solid

The **Width** describes the outline line style and is also used as the line style where Hatch or Cross-Hatch styles are used on the copper shape.

Copper Spacing Rules

Copper has its own spacing parameters defined on the **Technology** dialog under **Spacing Rules**.

Design	Design								
	Track	Pad	SMD Pad	Via	Micro-via	Testpoint	Mounting Hole	Copper	Text
Track	8.00	8.00	8.00	8.00	8.00	8.00	8.00	8.00	8.00
Pad	8.00	8.00	8.00	8.00	8.00	8.00	8.00	8.00	8.00
SMD Pad	8.00	8.00	8.00	8.00	8.00	8.00	8.00	8.00	8.00
Via	8.00	8.00	8.00	8.00	8.00	8.00	8.00	8.00	8.00
Micro-via	8.00	8.00	8.00	8.00	8.00	8.00	8.00	8.00	8.00
Testpoint	8.00	8.00	8.00	8.00	8.00	8.00	8.00	8.00	8.00
Mounting Hole	8.00	8.00	8.00	8.00	8.00	8.00	8.00	8.00	8.00
Copper	8.00	8.00	8.00	8.00	8.00	8.00	8.00	8.00	8.00
Text	8.00	8.00	8.00	8.00	8.00	8.00	8.00	8.00	8.00
Board	50.00	50.00	50.00	50.00	50.00	50.00	50.00	50.00	50.00

All listed items, as well as Copper itself, can be checked against Copper items within the design.

► To insert copper

1. From the **Insert** menu select **Insert Copper** then create the shape required.

The copper shape can then be created within the design. At any time, right clicking the mouse will display the context menu from where to select an option.

Changing the Grid

During **Insert Copper** or **Move**, you can change the grid on which the copper is positioned. This can be found on the context menu under **Change Grid**. You can change between the **Use Working Grid** or **Gridless (Use No Grid)**.

On-line DRC and Display Clearance

When added copper shapes, you can select use the On-line Design Rules Checking option, and to show clearances defined in the Spacing Rules dialog as a visual indicator. Both options provide actual and visual indicators that the copper shape being added or modified will adhere to the rules defined and does not violate any other electrical items. These options are available on the context menu during Insert Copper or Move.

Add To Net

Copper can be added to any net in the design once the shape has been added. This can be done using the **Add To Net** option from the context menu or by using **Properties** of the copper shape.

This can be used where copper shapes are placed up against another item that already has a net name. By giving the copper the same net name, the two items will be associated and will not produce errors.

Adding vias to copper

Vias can easily be added to copper shapes. These might be required where the copper shape must be connected to a ground plane. The vias providing multiple entry points to the plane for EMC shielding purposes.

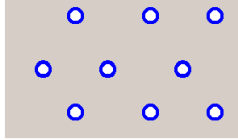

There are two methods:

► To insert vias into copper shapes

1. From the **Insert** menu, select **Insert Via**.
2. Options from the context menu allow the via to be inserted **Multiple** times and to be named using **Change Net**.

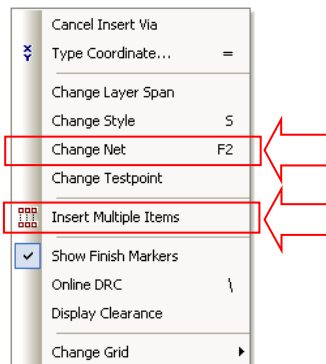

3. If the copper shape already has a Net Name associated with it, you can release the via over the copper shape and the via will take on the same net name.
4. If the copper is not named, and subsequently becomes named, you will need to use the **Change Net** option on the vias to give them the same net name as the copper.

► To insert vias into copper shapes using Apply Via

1. Select the target shape to apply vias to.
2. From the **Utilities** menu, select **Apply Via > Apply Vias to Selection**

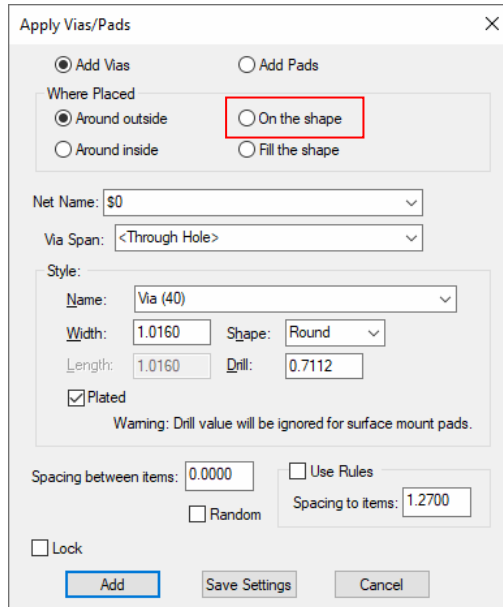

3. Select **Add Via** and select **On the shape**
4. Select the via Style you wish to add.
5. Select the **Spacing** or use the **Spacing Rule** and press **Add**.

Pouring Copper and Templates

Copper Pour is used to flood areas of a PCB layout with copper, usually connected to a nominated signal, typically Ground (GND) or VCC. This facility will then create voids around tracks, Component pads, vias etc.

If a copper area is to be inserted without the need for voids around unconnected tracks, components, pads etc. then the **Insert Copper** facility should be used.

The principle of this facility is to create a Template area and ‘pour’ the copper into this area. Different properties of the copper can be controlled in the **Technology** under **Rules - DFM/DFT** tab - **Copper Pour Rules** and **Thermal Rules.DFM/DTF Rules** tabs in the **Technology** dialog.

Setting up the Technology dialog

Copper uses its own spacing parameters defined in the **Technology** dialog, under the **Spacing Rules** tab as previously discussed for **Copper**. To create the clearances in the copper area it also uses the rules defined in the **Technology** file under **Rules - DFM/DFT** tab - **Copper Pour Rules**.

Copper Pour Rules

Attribute Name	Match Value	Avoid Same Net	Min Island Size	Isolated Islands		Hatched Copper	
				Remove	Make Non-Connecting	Is Hatched	Hatch Style
<Net Class Name>	GND2	<input checked="" type="checkbox"/>	2500.00	<input checked="" type="checkbox"/>	<input type="checkbox"/>	<input type="checkbox"/>	
<Net Name>	Sig*	<input checked="" type="checkbox"/>	2500.00	<input checked="" type="checkbox"/>	<input type="checkbox"/>	<input type="checkbox"/>	
<Net Name>	*	<input type="checkbox"/>	2500.00	<input checked="" type="checkbox"/>	<input type="checkbox"/>	<input type="checkbox"/>	

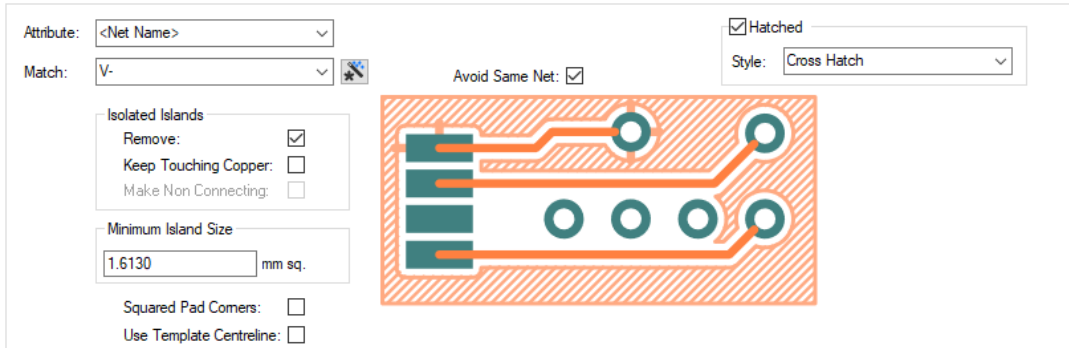

For **Copper Pour Rules** you may determine aspects of the poured copper.

The **Minimum Island Size** can be set for individual areas of copper within the design in the current design units. If a given area of copper falls below this size then copper will not be placed.



The **Remove Isolated Islands** means that if it is not possible to connect an island to the designated Net then the island will be deleted.

The two examples below show how isolated areas would be removed.

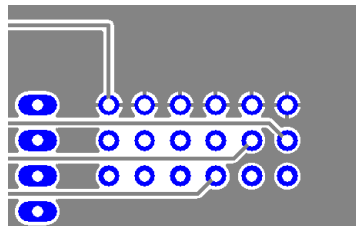
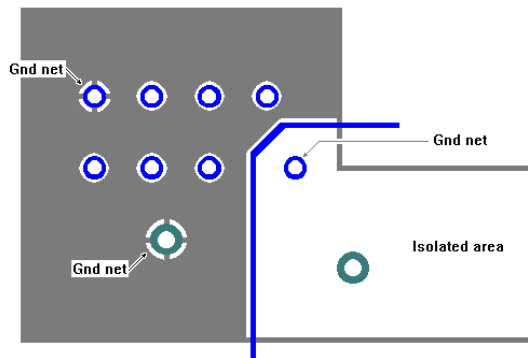

Avoid Same Net means that any nets that have already been routed or are copper will be avoided during pour, provided they are on the same net as the one being poured. If the option is checked, isolation will be left around any item on the same net within the pour area.

With 'Avoid' checked off

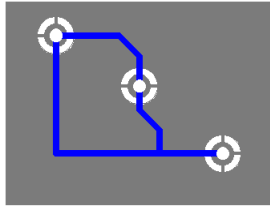

With 'Avoid' checked on

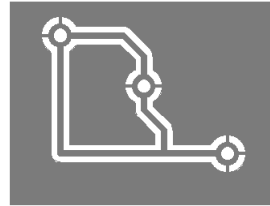

Hatched defines whether the **Copper Pour** is to be **Hatched**, and if so, the **Style** of the **Hatch** or **Cross-Hatch**.

Thermal Rules

Attribute Name	Match Value	Applies To	Min Pad Size	Connect Type	Thermal Pad Value				
					Isolation Gap	Spoke Style	First Spoke Angle	Num of Spokes	Min S
<Net Class Name>	GND	Via	0.000	Thermal Pad	0.254	Assembly Outline	0.0	4	2
<Net Class Name>	Power	Via	0.000	Not Isolated	0.254	Assembly Outline	0.0	4	2
<Net Class Name>	Power	Through Hole	0.000	Thermal Pad	0.254	Copper 10	0.0	4	2
<Net Class Name>	Power	All	0.000	Thermal Pad	0.254	Copper (0.3)	0.0	4	2
<Net Class Name>	*	Via	0.000	Not Isolated	0.254	Assembly Outline	0.0	4	2
<Net Class Name>	*	Surface Mount	0.000	Thermal Pad	0.254	Copper (0.3)	0.0	4	2
<Net Class Name>	*	Through Hole	0.000	Thermal Pad	0.254	Copper 10	0.0	4	2
<Net Class Name>	*	All	0.000	Thermal Pad	0.254	Copper 4	0.0	4	2

Attribute: <Net Name>

Match: *

Applies To: Any

Min Pad Size: 0.000

On Layers:
Side: <Any>
or
Layer:

Within Areas:

Connect Type: Thermal Pad

Enclosed Pads Only:

Orthogonal Spokes:

Isolation Gap: 0.254

Number Of Spokes: 4

Minimum Spokes: 2

Try Alternative Rotation:

Rotate With Pad:

First Spoke Angle: 0.00

Spoke Style: 0.127

<Thermal Relief Spokes>

This defines the thermal relief size and isolation of any pads within the poured area (**Thermal Pads**) and the copper itself using the **Minimum Island Size** and whether it is Hatched/Cross-Hatched or not (**Copper Pour**).

The **Thermal Pads** section related to the pads connecting the copper poured area to the nominated Net name.

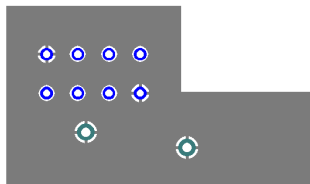

For thermal relief you may determine the Isolation Gap, the Spoke Width, the Number of Spokes and the First Spoke Angle.

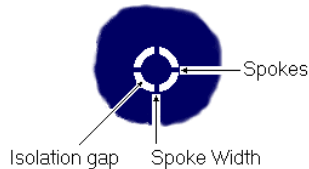

The **Isolation Gap** is the gap between the Pad and Copper connecting to the designated Net. The **Spoke Width** is the small copper strip between the Pad and Copper. The **Number Of Spokes** connecting the Pad to Copper can be defined as can the **First Spoke Angle** in current angle units (other spokes will be relative to this first spoke).

The area will flood with copper leaving an isolation area around tracks, pad, vias, connectors, etc. plus a copper connecting strip through the Thermal Pad to the nominated net.

Setting up Default Values

There is a default style setting for **Templates** in the **Design Settings** dialog under the **Defaults** tab. This is used when Insert Template is selected. The values shown by default exist in the Technology dialog.

When poured, the Copper area will use the default values taken from the **Copper** entry on the same dialog.

Creating a Template

1. From the **Insert** menu, select **Insert Template** then select the shape type (Polygon, Rectangle or Circle). Once the appropriate shape type is selected then the shape may be created on the design.

This Template may be outside the board outline if copper is to fill the complete board area. Any Template area outside the board outline will not be poured with copper using this facility. In this instance, the copper will be poured to within the *Copper to Board* spacing rules distance inside the board outline.

Attaching a Net to the Template

At any time; during addition or selection of an existing Template, a Net Name can be added to it using the **Add To Net** option from the context menu or by pressing **F2**.

Where the poured copper is associated with a net, the net name can be attached to the template prior to pouring the copper. With a net name attached combined with the **Act Poured** switch selected, this will also enable full checking and net Optimisation to the template even if isn't poured.

The **Act Poured** switch is selected from the **Options** dialog and **Interaction** tab.

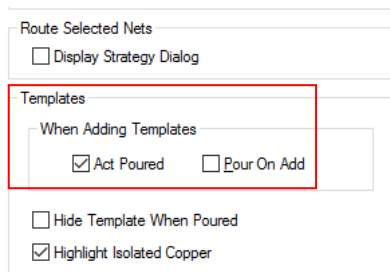

Pouring Copper

► To pour copper into a template

1. Click the Template outline; you don't need to select the whole shape.
2. From the **Utilities** menu select **Pour Copper**. You can also use the Pour Copper option from the context menu once the template is selected.
3. The Template area will fill with copper leaving voids around unconnected items.
4. To create copper hatching after pouring right click and select **Hatch**.

Warning: Do not remove the Template after pouring, you will not be able to easily remove the poured copper areas afterwards or make modifications to the copper shapes if required. Templates are not plotted and will not appear on your plots.

► To clear poured copper

1. Select the poured copper shape or Template outline.
2. Right click and select **Clear Template** from the menu.

Automatically pouring Templates

When a Template is created, at the point that the shape is completed the Template can be automatically poured with copper. This saves you then having to select the Pour Copper option.

To enable this mode, select the **Pour On Add** option from the **Options** dialog and **Interaction** tab.

Templates poured automatically can still be cleared using the **Clear Template** option, and hence why they should not be removed after pouring.

Pouring copper without a Template

In instances where the design does not have a template, because it was imported from another system or where you wish to convert a **closed** copper shape to a poured copper area with clearances, you can select the copper and pour copper into its outline. The copper shape will act as a template without having to recreate the copper shapes outline. For this to work successfully, the shape must be copper and must be closed. It will still work if the shape is Filled or Hatched.

Once the shape is poured, it will still be a copper shape without a Template outline but will contain voids where pads etc exist.

► Pouring copper without a Template

It is highly recommended that you try and avoid using Copper Pour without adding a template first.

1. Press **Shift** and select on the copper shape at the same time.
2. From the **Utilities** menu select **Pour Copper**. You can also use the Pour Copper option from the context menu once the template is selected.
3. The existing copper shape will be replaced with poured copper using the original copper shapes outline.

Isolating Pads From The Power Plane

A property exists on **Pads** (and Vias and Mounting Holes) that allows isolation and solid powerplane connections for use with both partial and split power planes, and for use with full CAM/Plot power planes.

For a selected pad, **Pad Properties** will allow you to alter the Power Plane Connection status for that pad instance only. If you wish to change the default status of a set of pads, you might want to consider creating a **Thermal rule** within the **Technology** to cover your requirement.

The image shows two parts of the software interface. The top part is a 'Pad Properties' dialog box with the following fields:

- Angle: 30.0
- Layer: <Bottom Side>
- Pad Style:
 - Name: Rectangle (0.9mm x 1.4mm)
 - Width: 33.46 Shape: Rectangle
 - Length: 55.12 Drill: 0.00 Id:
 - Plated

The bottom part is a 'Power Plane Connection' dropdown menu with the following options:

- Default
- Isolated
- Not Isolated
- Thermal Pad
- Thermal Pad (ignore Spacing Shape)

The **Power Plane Connection** property has four possible settings.

- Default
- Isolated
- Not Isolated
- Thermal Pad

Default will be the default setting for the pad.

Where the setting is **Isolated**, the pad it is attached to will be isolated from the plane or poured area without using any 'spokes' and will use the *Copper to Copper* spacing rule.

Where the setting is set to **Not Isolated**, the pad it is attached to will be a solid connection to the plane or poured area without any isolation or thermal relief.

Where the setting is **Thermal Pad**, this is the normal default setting and will allow a thermally connected pad to the plane using the **Thermal Rules** defined in the **Technology**.

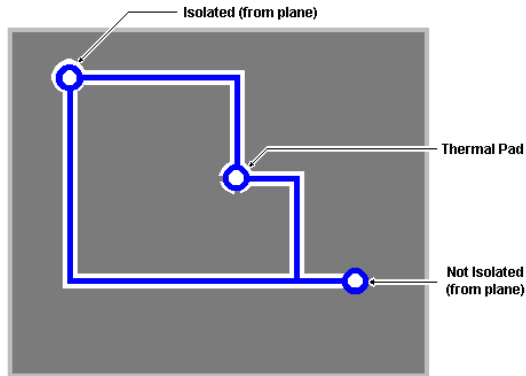

The illustration above shows the effect of the **Power Plane Connection** property using the **Isolated** and **Not Isolated** settings and with the **Avoid Same Net** switch set **off**.

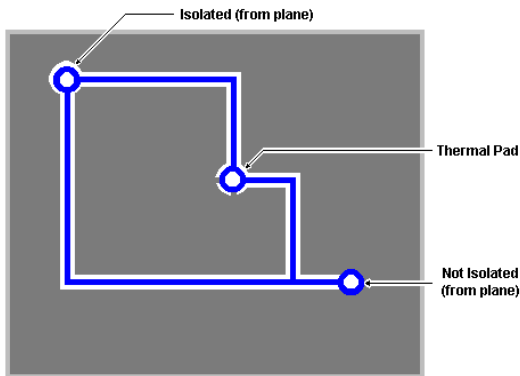

The illustration above shows the same example but with the **Avoid Same Net** switch set **On**.

For information on split planes, see later in the manual in the chapter on *Outputs for PCB Manufacturing*.

Automatic Copper Pouring

Once copper is poured into a template, Pulsonix allows you make changes to items that enter the copper and for the copper to be automatically repoured. This is a switchable option and is available on the Options dialog and Interaction page. The option is named **Repour Affected Templates**. It means that if you move a via or track slightly, the ‘damaged’ area around that item will be repoured without reporing the whole template.

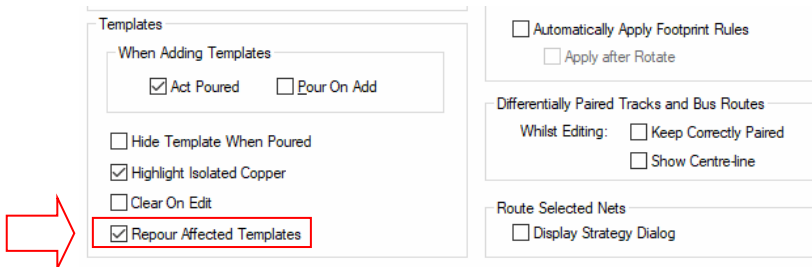

Using Teardrops

Teardrops are small copper 'fillets' used to obtain a smooth 'transition' between pad items and track. Historically, teardrops have been used to help increase manufacturing yields by reducing the possibility of over etching of items with sharp internal corners during the copper removal process using acid.

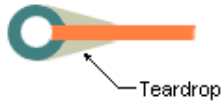

In most cases, over etching has been vastly reduced using modern spray etching techniques, but teardrops are still used where manufacturing is poorer or where PCBs are produced in very high volumes and yield (and hence reliability) are paramount. For example, in consumer electronics for manufacturing Televisions.

Teardrops are a feature of pad items and can exist between tracks on the following items: Pads, Vias, Testpoints, Tracks, Mounting Holes and Free Pads.

Pulsonix supports two types of teardrops: 'Normal' **Triangle** and **Curved Triangle**. Both types use copper associated with the pad to make the teardrop. The teardrop is dynamic, moving with the angle of the track entering the pad.

The curved triangle teardrop provides a more aesthetically pleasing teardrop but is equally functional.

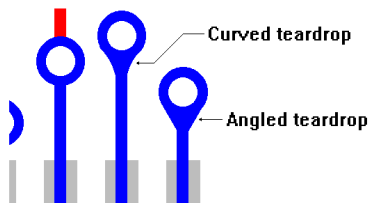

The colour used for the teardrop will always be the same colour as used for the track that it is connected to.

Setting up the Technology dialog

Teardrops can be set up in the **Teardrop Rules** tab in the **Technology** dialog.

Enable	Attribute Name	Match Value	Shape	Use Length	V-Angle	Length	Apply Teardrops To				
							Through Hole Pad	Surface Mount Pad	Via	Micro-via	Round Only
<input checked="" type="checkbox"/>	<Net Name>	*	Triangle	<input checked="" type="checkbox"/>	60.0	2.50000	<input checked="" type="checkbox"/>	<input checked="" type="checkbox"/>	<input checked="" type="checkbox"/>	<input checked="" type="checkbox"/>	<input type="checkbox"/>

Attribute:

Match:

On Layers:
Side:
or
Layer:

Within Areas:

Apply Teardrops To:

Through Hole

Surface Mount

Via

Micro-vias

Round Pads Only

V Angle:

Shape:

Use Length:

The shape and size of teardrops is defined from the teardrop settings. The choice of teardrop **Shape** is for the normal **Triangle** shape and the **Curved Triangle** shape. The Curved Triangle shape gives you a slightly less harsh shape than the traditional Triangle shape.

The **V-Angle** allows you to define the length of the teardrop based on its angle between the two items. A 60 degree angle is set as the default but can be changed to your own requirements. You can also change the **Length** of the teardrop to elongate it further than the angle would allow.

Once the teardrop has been added, the **Shape, V-Angle** and where they are **applied** can be interactively changed using **Properties** on the item. You would need to select the teardrop(s) first and then **Properties**.

Inserting Teardrops

Teardrops can be added (and removed) in a number of ways depending on the range of coverage of the teardrops within the design.

From the **Tools** menu, you have the **Teardrops** selection that allows the following:

Add Teardrop To All Nets This is used to make a selection of all the nets within the design and perform add teardrop on them.

Add To Browse Nets This will only perform an add teardrop on nets selected from those listed in the teardrops browse menu.

Add To Selected Nets This will only perform an add teardrop on clicked nets within the design.

You also have a more interactive mode that allows you to **Add Teardrops To Selection**. This mode is not on the menu but is available as a command and as a button for use on the Toolbar, by default it appears on the PCB Toolbar.

Using this mode it provides you with a focused operation, enabling teardrops to be added to single pads or both ends of a track segment. You can use it by selecting the item first and applying the teardrop with a single click of the toolbar button, or by selecting the button first to 'latch' the option, then selecting the item. You must cancel the option to remove it from its latched mode.

► To insert a Teardrop

1. Click on the **Tools** menu, click **Teardrops**. You may then select one of the options from the menu, or:
2. Select the item first and click the **Add Teardrops To Selection** toolbar button.

Removing Teardrops

Teardrops may be removed by selecting teardrops and the **Remove Teardrop** alternative to the options listed above.

► To remove a teardrop

1. Click on the **Tools** menu, click **Remove Teardrops**. You may then click one of the following:

Remove Teardrop To All Nets - This is used to make a selection of all the nets within the design and perform Remove Teardrop on them.

Remove To Browse Nets - This will only perform a remove teardrop on nets selected from those listed in the teardrops browse menu.

Remove To Selected Nets - This will only perform a remove teardrop on clicked nets within the design.

You also have a more interactive mode that allows you to **Remove Teardrops To Selection**. This mode is not on the menu but is available as a command and as a button for use on the Toolbar.

Using this mode provides you with a focused operation; enabling teardrops to be removed to single pads or both ends of a track segment. You can use it by selecting the item first and applying the option with a single click of the toolbar button, or by selecting the button first to ‘latch’ the option, then selecting the item. You must cancel the option to remove it from its latched mode.

Adding Dimensions

Dimensions used for documenting the physical measurements of the PCB can be added using the dimensioning facility in Pulsonix. Dimensions can be attached to items to be dynamic as that item is moved, or they can be unattached.

Insert Dimension is used to dimension items within the design, or gaps between items within the design. It is used to display (in the form of a dimension) lengths of items, radii of arcs and angles between lines.

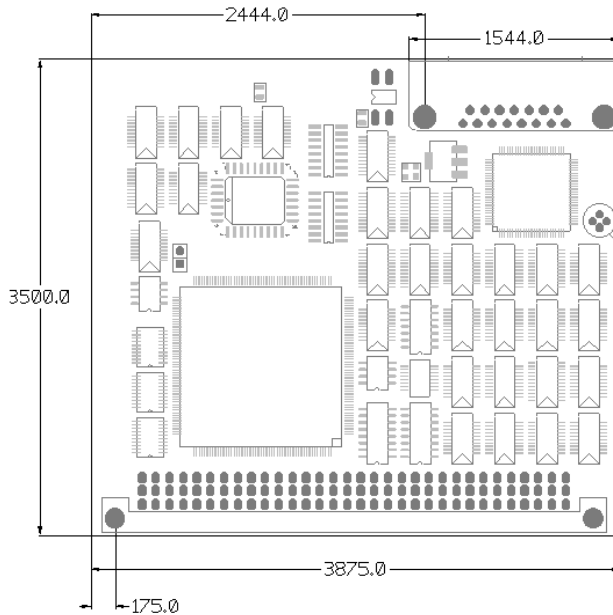

Setting up Default Dimension Values

There is a default style setting for **Dimensions** in the **Design Settings** dialog under the **Defaults** tab. This is used when **Insert Dimension** is selected. The style values shown by default exist in the **Technology** dialog.

Layer:

Text Style:

Arrows:

Line Style:

Head Width Multiplier:

Head Length Multiplier:

Text Gap: Filled Heads

Documentation Lines:

Line Style:

Extend By: Show: At Start At End

Start Gap:

Tolerance Text:

Text Style:

For Type:

Show

Horizontal and Vertical:

Text Angle: 90 Degrees Adjust Vertical

Text Avoids Arrow Line Keep Above or to the Left

Directional Type: Show Arrows

Free Angled:

Auto Rotate Text Text Avoids Arrow Line Keep Above or to the Left

Radial:

Display Diameter Arrow Across Diameter

No Arrow Heads Auto Rotate Text Text Avoids Arrow Line Keep Above or to the Left

Angular:

Auto Rotate Text Text Avoids Arrow Line Keep Above or to the Left

This dialog details how the dimensions will appear in the design. The above example is not complete.

Also on the **Defaults** tab are **Dimension Units**. These define the **Angle** and **Length** units of the dimensions being added.

Angle Units:

Degrees Radians

Precision:

Prefix: Unit Text:

Length Units:

Imperial:

Metric:

Precision:

Prefix: Unit Text:

Show Alternative Length Units:

Imperial:

Metric:

Precision:

Prefix: Unit Text:

Postfix:

Radial Length Units:

Imperial:

Metric:

Precision:

Prefix: Unit Text:

Show Alternative Radial Length Units:

Imperial:

Metric:

Precision:

Prefix: Unit Text:

Postfix:

Decimal Point Character:

Within this dialog you can set the **Angle Units** and **Precision** and the **Text** that is used if the units are displayed. The same applies for the **Length Units** where the **Units** are specified as is the **Precision** and the **Text** used to when the length units are displayed.

When using Dimensions, you can also change the look and style of the dimension by selecting it and using **Properties** from the context menu.

Adding Dimensions

There are five types of dimensions available during **Insert Dimension**:

- Horizontal
- Vertical
- Free Angled
- Radial
- Angular

Each of these is available from the **Insert** menu and **Insert Dimension**. You can also select any of the dimension types from the context menu once any Insert Dimension mode has been selected.

How to use Dimensions

► To insert dimensions

1. Select **Insert Dimension** from the **Insert** menu.
2. You are now in one of the **Insert Dimension** modes, by right clicking you will see the **Insert Dimension** context menu:

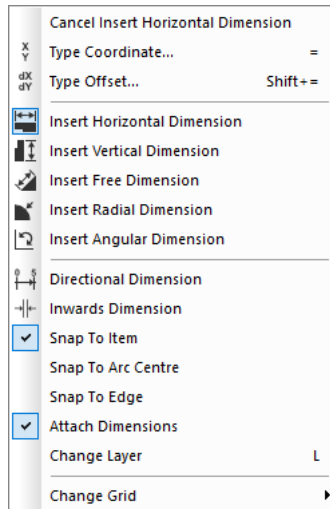

3. Select the type of dimension required.

From the context menu you can also select whether the dimensions will be **Directional** and an **Inward** dimension, how to **Snap** the dimension and if it is to be **Attached** or not.

► To insert dimensions

Use these options to dimension lengths of items and gaps between items in the design.

1. Select the **Dimension** mode from the context menu.
2. Select your **Dimension** preference and the **Snap** mode from the context menu.
3. Single click to pick the position to start the dimension from, or (if using **Snap To Item**) pick the item you wish to **snap** the dimension on to. The dimension will now be drawn on the screen.
4. Move the mouse to position the end of the dimension. The dimension text will be automatically updated to show the measurement between the dimension start and end arrows.
5. If adding a horizontal or vertical dimension, a construction line will be added from the moving start arrow head to the original start position.
If required, right click the mouse to use the context menu to change the type of linear dimension you are adding, or to change the layer of the dimension, or to change the grid you are using.
6. Single click to pick the position to end on, or (if using **Snap To Item**) pick the item you wish to **snap** the dimension on to.
7. Move the mouse to alter the offset of the linear dimension arrows from their original positions. Construction lines will be drawn from the moving arrow heads to the original points of the dimension. Use the context menu to change the grid that the dimension is moving on.
8. Single click to finish the dimension.

► To reset the dimension text default position

1. If the text displayed on the dimension was at its default position, it is moved to keep it at its new default position, otherwise it is not moved.
2. **Note:** If you want to put some dimension text back to its default position, select the text, right click and use **Reset Text Position** from the menu.

Attached Dimensions

There is a command, **Attach Dimensions** available from the context menu whilst adding and stretching **Dimensions**. Check this so that when a dimension is snapped to an item it will be attached to it (if it can).

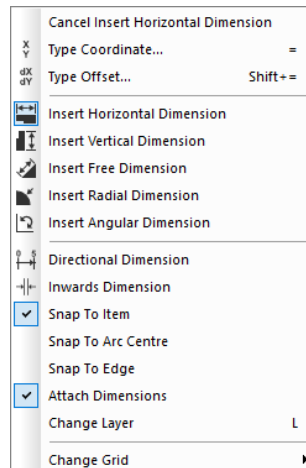

Moving items with Attached Dimensions

Moving or changing the item will cause the dimension to be stretched (and have its measurement altered). They will remain attached though.

Unattaching Dimensions

Dragging the dimension line attached to an item will present you with a dialog asking if you want to unattach the dimension.

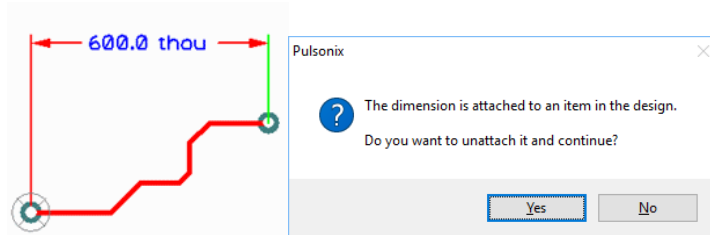

Click **Yes** to unattach it. You can reattach the dimension to another design item and the measurement will automatically update.

Highlighting Attached Dimensions

The **Attached Dimension/Callouts** colour setting under the **Highlights** tab of the **Colours** dialog can be used to highlight half of the dimension that is attached (or the whole dimension if fully attached). The unattached portion of the dimensions are drawn in the Dimension colour.

Name	Displayed	Colour
Attached Dimensions/Callouts	<input checked="" type="checkbox"/>	Red
Branch Point Via	<input type="checkbox"/>	Blue
Bus Tracks	<input type="checkbox"/>	Green
Clearances	<input type="checkbox"/>	Orange
Component Pad 1	<input type="checkbox"/>	Grey
Differential Pair Path	<input type="checkbox"/>	Yellow

Dimension Tolerances

When adding **Dimensions** you can automatically add **tolerance text** to the end of a selected dimension.

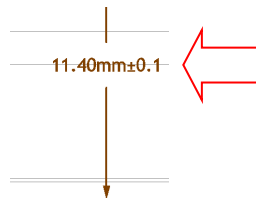

From within the **Properties** dialog of a **Dimension**, there is a tab to define the **Tolerance**.

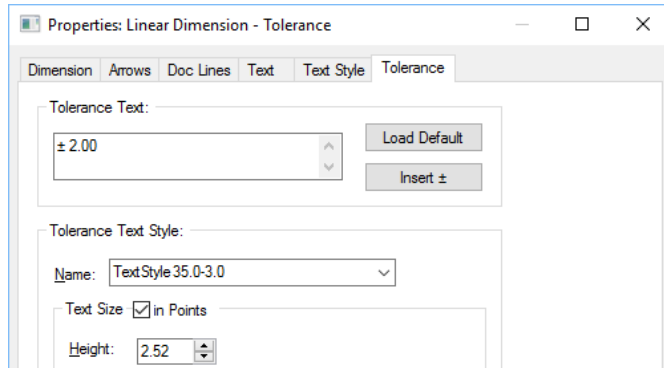

The tolerance text is a multi-line text item with its own text style, automatically attached to the end of the dimension text such that both text items are aligned through their vertical centres. The multi-line tolerance has been provided to create either unilateral or bilateral tolerances, or to be used for any other purpose you like.

11.40mm±0.01

A Unilateral Dimension example

11.40mm^{+0.02}_{-0.01}

A Bilateral Dimension example

As well as being able to type the tolerance text, you can use a button to insert the bilateral \pm character at the start of the text, and use the **Insert \pm** button to set the text to the default for that dimension type.

Default **Tolerances** can be set up in the **Design Settings** dialog, **Defaults** and **Dimensions**. These can be defined for each of the three types of dimension, linear, radial and angular. A default tolerance text style can also be set up.

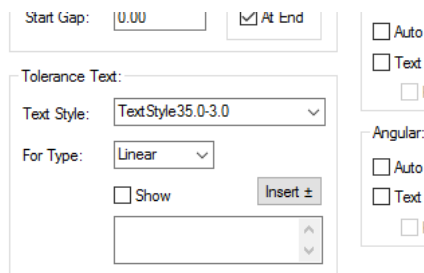

Saving Dimensions To A Profile File

Once dimensions are added to a design, they can also be saved to a **Profile File** for subsequent reuse. This is particularly useful if the dimensions detail the physical board and are required for other designs. To save the Profile file use the **Save Profile** option from the **Setup** menu.

Show both Metric and Imperial Units on Linear and Radial Dimensions

Linear and Radial dimensions can display both Metric and Imperial units for the same dimension.



Check boxes to **Show Alternative Length Units** and **Show Alternative Radial Length Units** are available on the **Defaults Dimension Units** page.

When selected, the alternative units text is added after the normal dimension distance text, enclosed in the Prefix and Postfix text, for example, **4141 thou (22.61 mm)**. Brackets and formatting can be added using **Prefix** and **Postfix** entries.

Angle Units:

Degrees Radians

Precision: 1

Prefix: Unit Text: deg

Length Units:

Imperial: thou

Metric: mm

Precision: 2

Prefix: Unit Text: mm

Radial Length Units:

Imperial: thou

Metric: mm

Precision: 2

Prefix: Unit Text: mm

Decimal Point Character: .

Show Alternative Length Units:

Imperial: thou

Metric: mm

Precision: 1

Prefix: Unit Text: thou

Postfix:

Show Alternative Radial Length Units:

Imperial: thou

Metric: mm

Precision: 1

Prefix: Unit Text: thou

Postfix:

Text Callouts

Text Callouts can be used in both PCB and Schematic designs and are used for documenting points of interest. Callouts can be ‘floating’ or attached to an item.

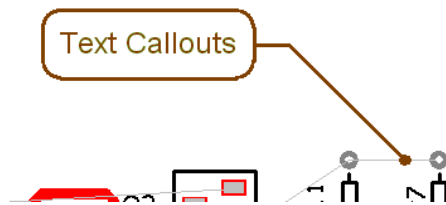

Text callouts consist of a text item, a shape around the text (the text box), a line from the text to the location of interest (the pointer), and a shape at the end of the line (the pointer end). These items are invisibly grouped so that it acts as one dynamic item in the design.

Text Callouts are added to the design using the option **Text Callout** on the **Insert** menu.

Using Text Callouts

From selection from the menu, select the pointer end position, you will be presented with a dialog to supply the text and layer (in PCB design). The layer can only be a non-electrical layer. The callout is displayed on the screen and you can place the text item at the required position.

The defaults for the styles, layer and appearance of new callouts are defined in the **Design Settings** dialog on the Setup menu. You can override this by selecting a **Text Callout** or **Free Text** item in the design before using the **Insert Text Callout** option.

Layer:

Text Style:

Line Style:

Move With Attached Item

Appearance:

Pointer End:

Pointer End Size:

Pointer Line:

Text Box:

Text To Box Gap:

Box Attach At:

Once added, the text callout can be moved for repositioning by selecting the outer edge and dragging it. The text box alone can be repositioned by selecting just the text. You can also drag the Pointer End to a different position.

You can change the text callout appearance by selecting it and using the **Properties** dialog from the context menu. You can change the **Appearance** of each of the entities.

Properties: Text Callout - Callout

Callout Line Style Text Text Style Variants

Position: Locked

Layer:

Move With Attached Item

Appearance:

Pointer End:

Pointer End Size:

Pointer Line:

Text Box:

Text To Box Gap:

Box Attach At:

Different styles of text callouts can be achieved by changing the **Properties** of these items.

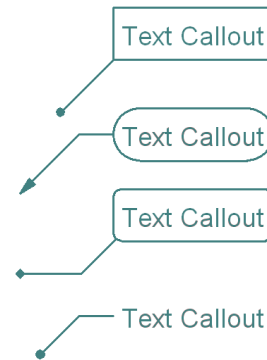

Attached Callouts

The command **Attach Callouts** is available from the context menu whilst adding and stretching callouts. Check this so when the end of a callout is positioned over an item it will be attached to it (if it can). **Shift-select** on a shape will attach a callout to the nearest point on a shape.

As with Attached Dimensions, if you attempt to move the callout near where it is attached, a warning dialog is displayed.

Callout Attributes

You can substitute any of the **attributes** of the attached item in the callout text. For example, when attaching to a component the text can contain the **Component Name**.

For the **Callout Text Properties**, enter your text (*Component*, in our example) plus the substitute attribute name (`%%<Item Name>%%` in our example). The text callout will then take on the item properties.

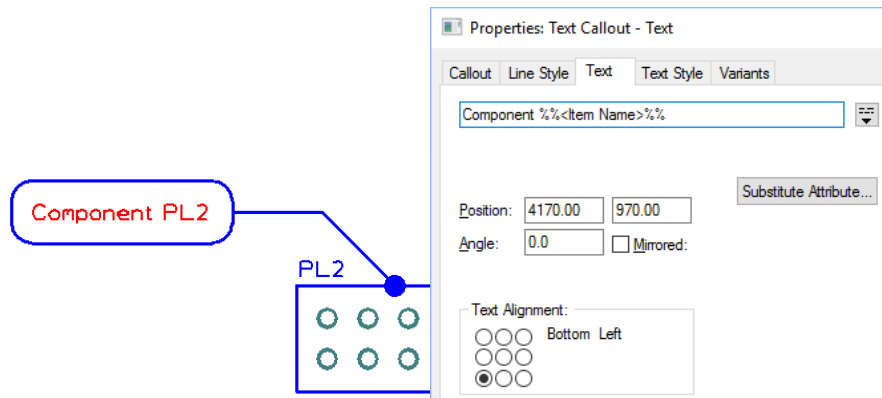

Measure Tool

The **Measure Tool** is used for measuring the distance between points or items in the design. This is available in the PCB design editor and Footprint editor applications (as well as the Schematic editor) in Pulsonix. It can also be used to show the gap between the edges of two items and the required minimum spacing between them. This includes the Drill-to-Drill distance between selected pads.

The tool also provides information about the dimensions of the picked items, and allows you to record the measurement in a report.

The **Measure Results** dialog displays information about the measurement made, the pictures below are split for ease of viewing:

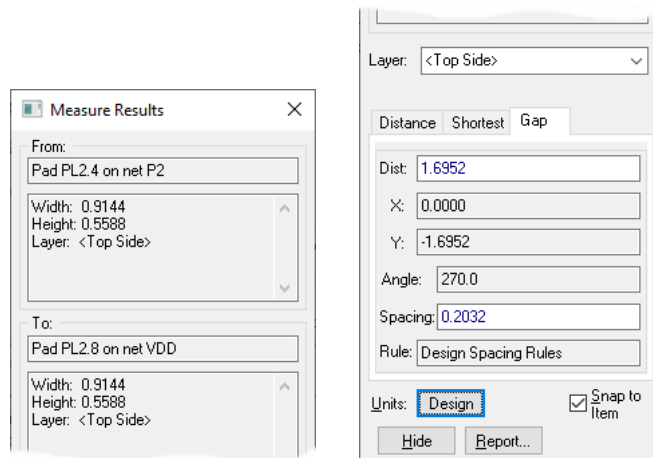

The dialog is shown split here for clarity. The top half displays dimensional information about the picked Items, or positions that the measurement was taken **From** and **To**. If there is more information that can be displayed, the vertical scroll bars are enabled to view all the data.

The bottom half shows the **Layer** being used. This shows the layer that the **Gap** between the items is measured on. If the two items are on completely different layers, 'Different' is shown. In this case the gap is still shown, but may not be that relevant. If a picked item contains different shapes on different layers, a pad with layer reassignments for example, you will be offered a drop down list of common layers between the items to choose from. When choosing a different layer, the measurement information tabs and the line displayed on the design will be updated to show the measurement on the chosen layer.

Under **Layer** are the **Measurement Information Pages**. These pages show different measurements between the two items. Picking a measurement tab will change the information page and alter the measurement line displayed in the design. The different measurements are as follows:

Distance - Shows the distance between the picked points, and the angle of the line between these points.

Shortest - Is only displayed after two items have been selected. It shows the shortest distance between the two items. Widths of lines are not considered for this measurement; use the Gap tab for edge-to-edge measurement. If a component is selected the shortest distance is measured to its placement area on the relevant layer.

Gap - Is only displayed after two items have been selected. It shows the smallest gap between the edges of the two selected items. If both items are electrical items, it shows the required **Spacing** between these items. This spacing is set to zero if the two items are on the same net. If two components are selected the spacing is the minimal component spacing. This page can be used to check two items to see if they are in error. If the gap is less than the required spacing, it will be drawn in red. If the layer is "Different" then the gap is not relevant unless one of the items changes layer.

Drill - Is only displayed if one of the two selected items has a drill hole. The distance shown is from the edge of the drill hole on these items. If both items have drill holes, the spacing shown is the minimum spacing required between drill holes.

Units

Use this to change the units used to display the lengths shown in the dialog. The button shows the units currently being used, and will show "Design" if the design units are being used. When pressed the Units dialog will be displayed.

During use of the **Measure Tool**, the context menu offers the **Snap To Items** and **Show Measurement** options.

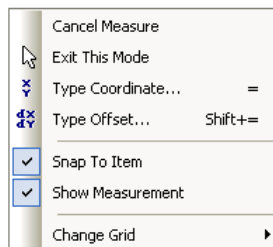

Snap To Item allows less accuracy on the picking of an item. This would be the normal mode of use. Leave it unchecked to restrict picking to positions in the design.

Show Measurement enables you to toggle the display of the **Measure Results** dialog. This provides more information about the items being measured and is designed to be placed to the left or right of

the screen. If you don't want the dialog in the way then hide it as the basic distance information is still displayed on the status bar.

A line is drawn between the two items representing the distance being reported.

Using PCB Attributes

This section details specific attributes associated with PCB Layout. The general process of adding attributes has already been covered in the Chapter under *Setting Up The Design*.

Displaying Attributes

All attribute names in the design are available in the Colours dialog. These can be set to be **Displayed**, **Selectable** and to have their individual colours changed. All system attributes are shown in brackets e.g. <Component Name>, <Date> and user defined attributes shown without brackets e.g. *Manufacturer*.

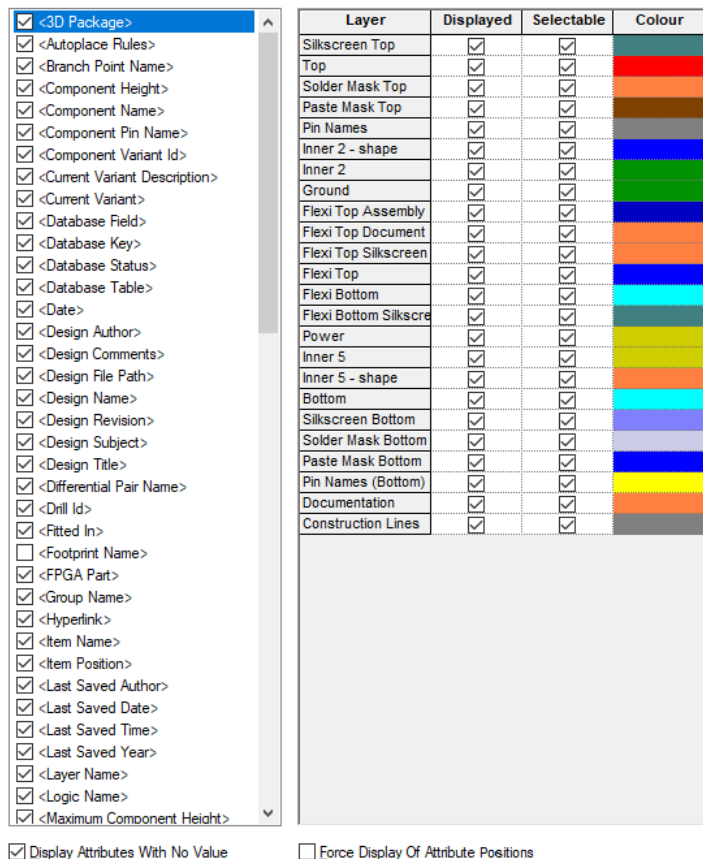

System Attributes

There are a number of system attributes that present themselves in the design as part of components and nets and other used design items. Attributes such as **Component Name**, **Gate Modifier**, **Part Name**, **Part Description**, **Net Name** etc. are used throughout.

There are some attributes that can be used to add design level information that changes dynamically as the design is updated. Attributes such as Date, Last Save Date/Time and Design Author are a selection these available attributes.

User Defined Attributes

New attributes can be added to any design item within Pulsonix. These user defined attributes can be extracted using the **Report Maker** output. Attributes on components that have their attribute names marked as being 'both' design types (PCB and Schematic) will be copied to the corresponding PCB Component when **Translate To PCB** is used.

Design Rules Checking

The Design Rules Check is used to check that the spacing rules defined in the Design's Technology file are not violated within the design or Footprint. This is also used to check various manufacturing rules have been obeyed.

When errors are found **Error Markers** are added to the design on the appropriate layer to help you find and correct the error.

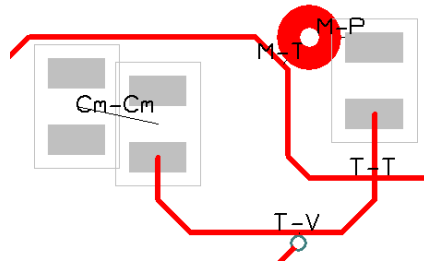

► To run a Design Rules Check

1. The **Design Rule Check** option can be run from the **PCB Toolbar**, the **Tools** menu and the **DRC Errors Browser** on the context menu.
2. A dialog is then displayed that allows you to control which items are included in the check.

Design Rule Check

<input checked="" type="checkbox"/> Spacing <input type="checkbox"/> Back Drill <input checked="" type="checkbox"/> Board <input checked="" type="checkbox"/> Components <input checked="" type="checkbox"/> Copper <input checked="" type="checkbox"/> Drills <input checked="" type="checkbox"/> Mount Holes <input checked="" type="checkbox"/> Pads <input checked="" type="checkbox"/> Split Planes <input checked="" type="checkbox"/> Test Points <input checked="" type="checkbox"/> Text <input checked="" type="checkbox"/> Tracks <input checked="" type="checkbox"/> Vias <input checked="" type="checkbox"/> Keep In/Out <input type="checkbox"/> Component Pads <input type="checkbox"/> Component Mount Hole <input checked="" type="checkbox"/> Components <input type="checkbox"/> Copper <input type="checkbox"/> Drills <input checked="" type="checkbox"/> Test Points <input checked="" type="checkbox"/> Tracks <input checked="" type="checkbox"/> Vias	<input checked="" type="checkbox"/> Manufacturing <input type="checkbox"/> Acid Traps <input type="checkbox"/> Bond Wire Length <input type="checkbox"/> Component Name <input type="checkbox"/> Copper Shapes <input type="checkbox"/> Copper Sliver <input type="checkbox"/> Copper Text On Board <input type="checkbox"/> Drill Backoff <input type="checkbox"/> Footprint Rules <input type="checkbox"/> Flex Bend Regions <input type="checkbox"/> Incorrect Back Drills <input type="checkbox"/> Isolated Copper <input type="checkbox"/> Minimum Copper Width <input type="checkbox"/> Minimum Pad Land <input type="checkbox"/> Minimum Text Size <input type="checkbox"/> Mirrored Text <input type="checkbox"/> Modified Templates <input type="checkbox"/> Pad Undersize <input type="checkbox"/> Panel Items On Board <input type="checkbox"/> Plane Thermal Pad <input type="checkbox"/> Silkscreen Overlap <input type="checkbox"/> SMD To Corner <input type="checkbox"/> Solder Mask To Track <input type="checkbox"/> Solder Mask Width <input type="checkbox"/> Split Plane Pad <input type="checkbox"/> Unpoured Templates <input type="checkbox"/> Wire Cross <input type="checkbox"/> Wire Under Component	<input checked="" type="checkbox"/> Nets <input type="checkbox"/> Adjacent Nets <input type="checkbox"/> Connection Length <input type="checkbox"/> Connection Vias <input type="checkbox"/> Copper Neck Width <input type="checkbox"/> Creepage <input type="checkbox"/> Differential Pairs <input type="checkbox"/> Loop Antennae <input type="checkbox"/> Necked Track <input type="checkbox"/> Net Connectivity <input type="checkbox"/> Power Planes <input type="checkbox"/> Parallel Track <input type="checkbox"/> Pin Order <input type="checkbox"/> Return Path <input type="checkbox"/> Same Net Via To SMD <input type="checkbox"/> Serpentine <input type="checkbox"/> Single Pin Nets <input type="checkbox"/> SMD To Plane <input type="checkbox"/> Stub Routing Length <input type="checkbox"/> Stub Vias <input type="checkbox"/> Teardrops <input type="checkbox"/> Track Layer <input type="checkbox"/> Track Length <input type="checkbox"/> Track Mitring <input type="checkbox"/> Track Width <input type="checkbox"/> Unfinished Track <input type="checkbox"/> Via Size <input type="checkbox"/> Via In Pad	<input checked="" type="checkbox"/> Testpoints <input type="checkbox"/> Centre to Centre <input type="checkbox"/> Min Points Per Net <input type="checkbox"/> Pad Size <input type="checkbox"/> Under Component <input type="checkbox"/> Unreachable Side <input checked="" type="checkbox"/> On Grid <input checked="" type="checkbox"/> Components <input checked="" type="checkbox"/> Pads <input checked="" type="checkbox"/> Test Points <input checked="" type="checkbox"/> Tracks <input checked="" type="checkbox"/> Vias <input type="checkbox"/> Validate Attributes <input type="button" value="Select All"/> <input type="button" value="Deselect All"/>
---	--	--	--

Acceptance Rule Set <input type="button" value="Load"/> <input type="button" value="Save"/>	Error Markers <input type="checkbox"/> Clear Locked Errors <input type="checkbox"/> Clear Warnings <input type="button" value="Clear All Errors"/> <input type="checkbox"/> Recheck Locked Errors	Output <input checked="" type="checkbox"/> Generate Report <input checked="" type="checkbox"/> Report Rules Not Checked <input checked="" type="checkbox"/> Show Errors Bar <input type="checkbox"/> Fully Expand Bar	Source <input checked="" type="radio"/> Design <input type="radio"/> Selection <input type="radio"/> Window
---	---	---	--

3. Select the items you wish to check.

Using the DRC dialog

Spacing Checks

Use the check box next to the **Spacing** title to choose whether any checks on the space between items will be performed. Then, if spacing checks are required, choose the types of items you wish to perform spacing checks on. Selected item types will be checked against all other items in the design in accordance with the **Spacing Rules** defined in the Design's Technology data.

*Notes: **Split Planes** - These are templates that are on power plane layers. This spacing check checks for overlapping Split Planes. They are allowed to touch each other, but not cross over.*

On-Grid Checks

Use the check box next to the **On Grid** title to choose whether any grid checks will be performed. Then, if grid checks are required, choose the types of items you wish to perform grid checks on. Selected item types will be checked for being on their appropriate grids. For example, all track segments are on the track grid. Please refer to the **Grids** on-line help page for details on how to set up these special grids.

*Note: Pads do not have their own grid. They are checked against the **Track** grid.*

Keep In/Out Checks

Use the check box next to the **Keep In/Out** title to choose whether any area checks will be performed. Then, if area checks are required, choose the types of items you wish to perform area checks on. Selected item types will be checked to. You can set the rules on Areas using the **Properties** dialog. Selected item types will be checked to see if they are in or out of any **Areas** that have **Keep In/Out** rules set up.

Manufacturing Checks

Use the check box next to the **Manufacturing** title to choose whether any manufacturing checks will be performed. Then, if manufacturing checks are required, choose the checks to perform.

Testpoints Checks

You can choose separate **Testpoint** checks if required.

Nets Checks

Use the check box next to the **Nets** title to choose whether any of the net checks will be performed. Then, if net checks are required, choose the checks to perform.

Dialog Utilities

Clear Locked Errors is used to force all locked errors to be cleared from the design. Normally, locked errors are retained but ignored on subsequent design rules checks. See the notes below regarding locking errors.

Normally, only the Error Markers of the type you are checking will be removed from the design prior to running the checker. If you want to remove all the errors in the design, press the **Clear All Errors** button. This button will be disabled when there are no errors in the design to delete.

Use the **Source** button to choose between checking the whole design or just checking the selected items in the design or footprint. If no items were pre-selected, the **Selection** option is not available. If checking **Selection** only, then each selected item will be checked against all other items (selected or not) in the design.

Use the **Report** button to produce a report of all Errors Markers that are generated by this Design Rule Check session. Errors Markers that were already in the design prior to this session will not be included.

Use the **Show Errors Bar** check box to display the error markers in the Errors Bar once DRC has been run.

Note: If there are several errors between two items, only the first is reported.

DRC Error Markers

When an error is found an **Error Marker** is added to the design on the correct layer and close to the error location. This Marker is displayed as a text string showing a **Code** for the type of error found.

Next to the code, in the same colour as the Error Marker is a line showing the gap between the two items in error. This line is only included if the error is between two items.

For more information about a DRC Error, hover the cursor over the error to display the item tooltip or select it and use Properties.

Locking Errors

Errors can now be locked using the **Properties** page or from the **Errors Browser**. This means that they are not normally removed on subsequent DRC checks, and are reported separately in the **Errors Report**. The purpose of this is to mark errors that you consider to be acceptable, and that will not be brought to their attention next time a DRC is performed.

Locating Errors

After DRC Check, you can find the Error Markers in the design using the **DRC Errors Browser**. You are able to locate error markers by type and cycle through them using the **Next Error** command.

The **DRC Error Browser** is used to view all the design error makers as a sorted list. This list is displayed in an 'active' browser that, by using double-click to select, can be used to locate the error maker in the design. This browser can be un-docked as a modeless dialog or docked as part of the Pulsonix framework. Use the right hand mouse button to make this selection.

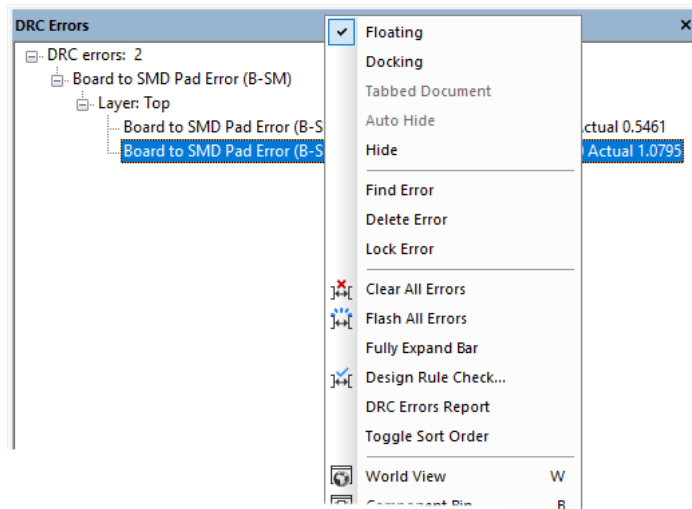

The browser is categorised in order of rank starting with Design (DRC errors), then Layer, then Error type, then the Marker itself.

Running DRC in the Footprint Editor

As well as the **Design Rules Check** and **On-line DRC** options in the main PCB design editor, you can also run the batch DRC option from within the PCB Footprint Editor.

By moving this process further 'up-stream' to where the Footprints are being created, you can check them before they are released to the library for use.

Synchronising The Designs

The **Synchronise Designs** option is available in both schematics and PCB, and can compare and make changes in the corresponding design. Using this option you can perform **ECOs** (Engineering Change Orders) to your design.

You can use Synchronise Designs at any time to verify that the netlists are the same. If there are differences, a dialog will appear, allowing you to view a report and perform an update. The report will give you a list of changes that would have to be made to the PCB in order to make it match the schematic. You can then perform these changes automatically by selecting the Update PCB option.

Normally you will want to compare the corresponding schematic and PCB designs, but you can specify a different design if you wish.

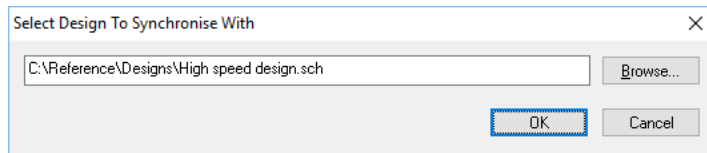

The recommended way of working is to create a schematic design, then use **Translate To PCB** to create the PCB design. The schematic design is considered the master and engineering changes should be made to the schematic and passed forward to the PCB using **Synchronise Designs**.

Examples of engineering changes are adding or deleting component pins from nets, and adding or deleting components. Engineering changes can be destructive and performing an update on the PCB may result in tracks being removed. Large scale alterations to the netlist will result in large scale changes in the PCB.

If you do make engineering changes in the PCB, **Synchronise Designs** will report these differences, but updating will change the PCB design, removing the changes you have made. In this case you should make the corresponding changes in the schematic by hand, if you wish to make it match.

Note that PCB only components and PCB only pins on components are not part of the design comparison because there is no matching entity in the schematic.

Annotation changes can be made in the PCB, and these can be passed back to the schematic using **Back Annotate** from within the Synchronise Designs option when back annotation data is available (after PCB changes). It will inform you of pending changes and allow you to perform any back annotation. It is recommended that you do this before updating the PCB, because the design compare it performs does not take any pending back annotation into account.

Options available on the **Options** dialog under **Synchronisation** tab allow you to make additional choices of what pin swaps are back annotated during Back Annotation.

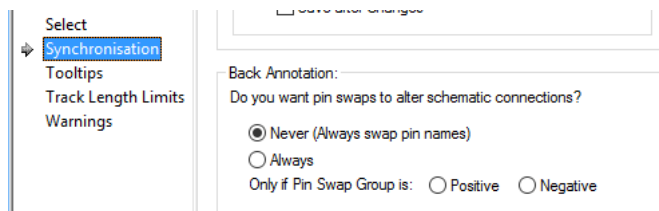

You should consider using the PCB Safe Mode option on the **General** tab in **Options**. This will prevent you from making engineering changes in the PCB, which should be made in the schematic design and passed forward using the method described above.

Importing ECOs from external sources

The **Import ECO** option on the **File** menu is used for importing external CAE designs or Schematic design netlists that have been subjected to modifications or Engineering Change Orders (ECOs). These designs will be in an ASCII format and will be recognised and supported by Pulsonix.

The ECO files for a design created in the Pulsonix Schematic editor will be automatically imported using the **Synchronise Designs** options rather than the **Import ECO** option.

Pulsonix automatically knows which source was used to create the PCB design and as such will not allow the **Import ECO** option to be used in some instances, for example, where the PCB was created without a netlist or using a Pulsonix Schematic design. The option is greyed out on the menu if an **Import ECO** is not applicable.

Full ECO Back to the Schematic

Enabling Full Back ECO

If you do want to make engineering changes (ECOs) in the PCB, you can treat the PCB design as the master and use **Synchronise Designs** to update the Schematic.

► To set up a PCB design as the master

1. Synchronise the two designs first to ensure they match (select the option from the **Tools** menu).
2. In the **PCB** design, take it out of **Safe Mode** by unchecking the **PCB in Safe Mode** box on the **Design Settings** dialog, **Synchronise** page.

The screenshot shows the 'Synchronise' page of the 'Design Settings' dialog. The 'PCB in Safe Mode' checkbox is unchecked and highlighted with a red box. Below it, the 'Allow PCB Only single pin nets' checkbox is checked. The 'Synchronised Design Name' field contains 'Announcer'. The 'Back Annotation' section has 'Enabled' checked and a 'Clear History' button. The 'Synchronise with Schematic' section is partially visible at the bottom.

3. Enable **Backward Design Changes** by checking the **Allow Update of Schematic to match PCB** box for the **PCB** design on the **Design Settings** dialog, **Synchronise** page.

The screenshot shows the 'Synchronise with Schematic' section of the 'Design Settings' dialog. The 'Allow Update of Schematic to match PCB' checkbox is unchecked and highlighted with a red box. Other checkboxes include 'Apply All Rules Strictly' (unchecked), 'Apply Spacing Rules' (checked), 'Apply Footprint Changes' (checked), 'Apply Net Class Changes' (checked), 'Apply Net Colours' (unchecked), 'Apply Schematic Track & Via Size Rules to Net Styles' (unchecked), 'Apply Schematic Title & Subject' (checked), and 'Ignore Attribute White Space' (unchecked).

4. In the **Schematic** design, on the **Design Settings** dialog, **General** page, for the **Schematics Safe Mode** entry. The default mode in the standard Technology files is for it to be unchecked (not in Safe Mode).

<input checked="" type="checkbox"/> Translate to PCB - Safe Mode	Part Status
<input type="checkbox"/> Allow PCB Only single pin nets	<input type="checkbox"/> Ignore SCM Only Status
<input type="checkbox"/> Schematics in Safe Mode	
Synchronised Design Name	
Name: LED Display-3	

► To apply PCB changes to the Schematic

1. Make the engineering changes to the **PCB** design and use **Synchronise Designs** to update the **Schematic** with the changes.
2. When performing the **Synchronise Designs**, you are presented with a dialog from which to define the design to update.

Select Design To Synchronise With

Which Design is to be Updated?

Update the PCB to match the Schematic

Update the Schematic to match the PCB

Master: E:\Design1.pcb

Update: E:\Design1.sch

3. Once **OK** is pressed, you can then proceed to the standard **Synchronise Designs** dialog. This now shows the **Update Schematic** button to show that this is the design type being updated.

Synchronise - Design Changes

Differences found between the PCB and Schematic

Update PCB

View Report

Save Updated Design

Components Will Be Deleted

Leave Connection

Cancel

4. Any new Components added will appear in the **USED ITEMS:** section of the component bin in the schematic design.

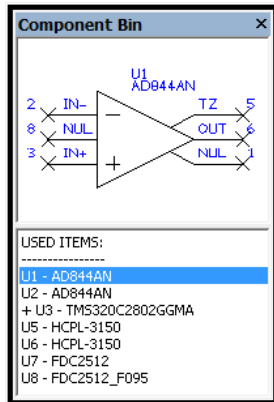

Some changes may not be able to be made to the Schematic design, for example, when the change is in a multiply instanced hierarchical block. You will be warned if changes could not be made and will have to either change the PCB design a different way, or change the Schematic design so that the updates can be made.

The difference between a full back ECO and Reverse Engineer

In principle, running a full back ECO is the equivalent of running a Forward Design Change, but obviously the other way around. Whereas, running Reverse Engineer is the equivalent of running a Translate To PCB (but in reverse). However, the Reverse Engineer option will also allow you to automatically place the components and route the connections.

Cross Probing Designs

Cross Probe works between two corresponding designs, a Schematic and a PCB. Items in the first ('source') design are selected, and Cross Probe locates the corresponding items in the other ('target') design. It can operate in either direction, from Schematic to PCB or from PCB to Schematic.

As with other Latch mode commands, Cross Probe can be used either on the current selection (in which case the Probe action is carried out once), or with nothing currently selected (in which case Cross Probe is 'latched', allowing you to select a number of items to probe in succession).

The items you can Cross Probe are:

- Components
- Component Pins/Pads
- Nets

The action taken in the target design depends on the mode in which the target design is currently operating. If this mode (the 'target mode') is the default Select Mode, items in the target design are simply selected. This allows you to use Cross Probe to help you browse the target design to locate items of interest. If the target mode is an interactive editing mode such as 'Place', selecting items in the source design will actually locate the corresponding items in the target design and allow you to place them.

Enabling the Cross Probing mode

There is a setting on **Options** under the **Interaction** tab that sets Cross Probe to **Bring the probed design to the front** if you wish.

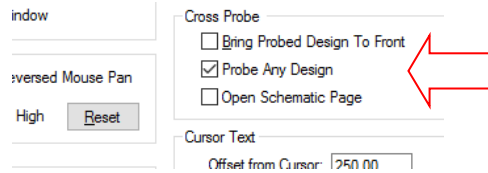

In the source design, choose **Select Mode** and make sure nothing is selected. Use **Deselect All** from the context menu if necessary. Now choose the **Cross Probe** option. The cursor will change to show that you are now in Cross Probe mode. As you select on items in the source design, the matching item will be selected in the target design, as shown in the picture below:

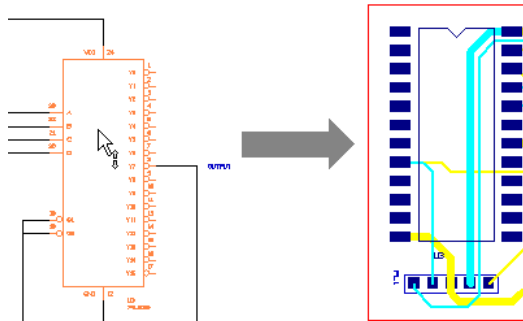

In the example above, by selecting the Component in the Schematic editor, the corresponding Component has been selected in the PCB design.

Finding Items Using Cross Probe

Perhaps the most common use of Cross Probe is to help you locate or view items in one design when you only really know your way around the other one. For example, you may be familiar with the location and arrangement of the components in the Schematic, but you need to find the corresponding components in the PCB design.

► To find items using Cross Probe

1. Firstly, open the two corresponding designs. Cross Probe locates items by their type (e.g. Component, net) and their name. It will actually probe between any two designs, but the source and target designs should really be the matching Schematic and PCB for the same circuit, and they should also both be up to date.
2. Any outstanding back annotation or design changes should be applied before using Cross Probe, otherwise the wrong items may be found because the names have not been synchronised.
3. For ease of viewing, arrange the two designs side by side on the screen. Cross Probe will if necessary Pan or Zoom the target design to show the item being probed, but it makes sense to be able to see the whole of the target design so you can see what's happening.

Editing Items Using Cross Probe

Using Cross Probe to edit items is very simple and yet extremely powerful. It provides you with the capability for engineer driven layout, for example allow the engineer to place critical components on the layout before passing the design onwards for completion.

It operates in the same basic sequence as for simply selecting items.

► To edit items using Cross Probe

1. Open the two designs (Schematic and PCB) that you wish to Cross Probe.
2. Arrange the two windows so you can see what you are working on. In the target design, select the mode you wish to use. For our example, we will use "Place" to allow us to place components on the PCB by selecting them from the Schematic.
3. In the source design, make sure nothing is selected, and then choose the Cross Probe option. The cursor changes to show you that Cross Probe mode is operating.
4. Next, on the Schematic, find the first Component you wish to place, and select it. The corresponding item in the PCB design will be picked up so you can place it in the desired location. Once the Component has been placed, return to the Schematic and select the next Component to be placed. This can be repeated for as many components as you wish to place.
5. As well as placing components, this powerful feature can be used for many other operations, for example to AutoRoute selected nets, or to mirror a whole group of components to the other side of the board.

Selecting Multiple Items

As well as Cross Probing individual items, you can also probe multiple items using the normal selection mechanism.

► To Cross Probe multiple items

1. To **Cross Probe** all the items in a given area, use **Frame Select**. Cross Probe will happen as soon as the frame select is complete.
2. To **Cross Probe** a particular set of Components, use <Ctrl-Select> or <Shift-Select> to extend or modify the selection.
3. When you have selected the desired set, simply **Select** one of the items already selected, and the **Cross Probe** operation will happen.

Cross Probe When Items Are Already Selected

If you choose the Cross Probe option when there are already items selected in the source design, then Cross Probe will operate as a 'single shot' action. The program will not stay in Cross Probe mode once the probe action has been carried out.

Printing the Design

When you wish to obtain a hard copy of your design, there is a choice of two methods for outputting prints and plots from Pulsonix:

- The Print option from the File menu will print the current design exactly as it appears on the screen. It will output to the selected Windows printer and will be automatically fitted to the paper size.

- The CAM Plot option from the Output menu to Print or Plot a user defined output to a selected device using defined parameters. This allows you to also choose not to include some design item types. Using this method, Pulsonix plots everything in the design on a per page basis unless excluded from a plot. The control over the size, scale, position and contents can be defined using the tools provided.

Using the Print Option

The print option is a quick and easy method of generating a print of the PCB using your default Windows printer.

When selected, the standard Windows **Print** dialog is displayed.

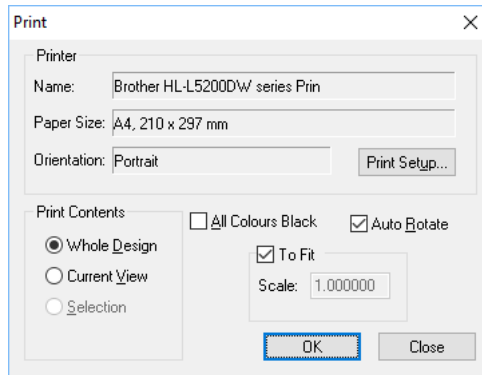

From this dialog you can select the number of copies to be made and select the print range.

The **Properties** button on this dialog gives you access to more advanced printer specific options allowing you to change other settings.

If you wish to make all colours on the screen black regardless of their displayed colour select the the **Always Print in Black** check box.

Print will reproduce on the paper exactly what is visible on the screen, therefore control of what appears in the print is achieved by adjusting the on-screen view. The on-screen view will automatically 'best fit' to the selected paper size although it is possible to change the chosen orientation of the print via the Printer Properties mentioned earlier.

If a more specific and consistent print is required, independent of the screen view, the **CAM/Plot** option on the **Output** menu should be used.

The **CAM/Plot** option is a fully configurable single 'shot' output option that allows you the full flexibility to output the plot required. This is discussed in more detail in the next Chapter.

Assembly Variants

Introduction

Variants allow the creation of multiple build assemblies within a single PCB, or Schematic design file. A design with variants has a common bare board (which means that tracks and copper do not vary) but has the potential for different component variants.

How component variants can be used

There are four possible 'states' for component variants:

- You can have components fitted or not fitted in any particular variant.

- For each variant, components can have different Parts for the same Reference name, for example, R1 could be a 4308R-102 1K or a 4308R-102 2.2K. If you have the Pulsonix Database Connection (PDC) product, this will also show next to the list of Parts available.
- For each variant, the same component (R1) can have different footprints, for example, R1 Part 4308R-102 1K could have a RES300 or RES400 footprint. These could even be with a different number of pads.
- For each variant, the same component can have different Attribute values. For example, R1 with a value of 1K for the USA variant could be 1K1 for the GB variant.

These variants can be used in any combination for each component.

The Variant Manager

The **Variant Manager** is available on the **Setup** menu under **Variants**. This button takes you to the **Technology** dialog and **Variants** page. This dialog allows you to create, modify and manage the variants for your design.

	Current	Name	Description
	<input type="checkbox"/>	<Master Design>	Entire Contents of Master Design
Y	<input checked="" type="checkbox"/>	USA	120V variant
Y	<input type="checkbox"/>	GB	240V variant
Y	<input type="checkbox"/>	EU	220V variant

Name:

Used:

Description:

Global Settings

Show Variant on Status Bar

Not-Fitted Components:

Display

Use the **New**, **Copy** and **Delete** buttons to create and manipulate each variant.

When you first enter this dialog, there will be no entries. On pressing **New**, you will automatically see **<Master Design>** displayed as the first entry. With any variants created, this is always available. If you delete all variants in a design, **<Master Designs>** will also be removed.

Selecting **<Master Design>** from the list as the current variant temporarily disables the use of variants by showing all components as fitted. However, they are not treated as fitted, otherwise you would get DRC errors.

Type the new Variant **Name** and optional **Description** in.

Once a variant has been added, the variants list order may be modified using the **Move Up** and **Move Down** buttons. You might do this to change the order for aesthetic purposes or to sort them into alphabetical order but this does not affect their use. This will be the order they appear in once viewed in **Properties** or within the **Variant Spreadsheet**.

If you wish to now use variants, you must select a variant name from the list before exiting the **Variant Manager**.

Assuming you have selected a variant by name before exiting, you may now make components in the design 'variant specific'. Again, verify this by checking the Variant name in the program caption at the top of the window or within the **Status Bar** if this option has been selected.

Dialog Switches

The selection for **Not-Fitted Components** allows you to define whether these are displayed in the design by checking the **Display** box. With this deselected, Components that are not fitted will not be displayed within the design.

Under **Global Settings**: you can use the **Show Variant on Status Bar** check box to automatically show you which Variant is currently in use.

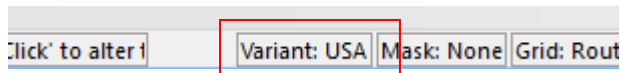

Selecting a variant name from the list and pressing **Apply** or **OK** will set this as the current variant in the design.

Viewing the Variant status

Once a variant has been created in the Variant Manager and selected in the Variants list, the Current Variant is displayed in the Pulsonix design caption at the top of the design window. This is your confirmation that a variant is selected and that it is the one required.

The variant is shown as the **design type** (PCB or SCM) and the **Current Variant** name in brackets. This name changes as a different variant is selected in the Variant Manager.

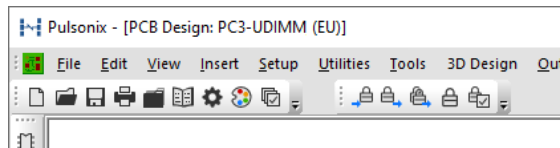

By double-clicking on the **Variant name** on the **Status Bar**, Pulsonix will display a short form of the Variant Manager to use.

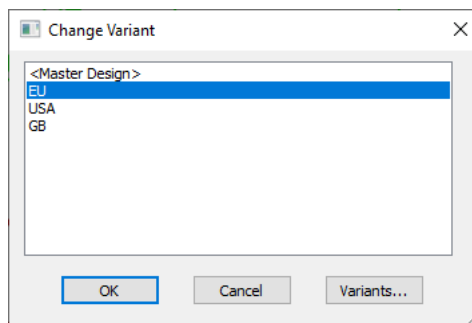

Components in Variants

Introduction to the Properties dialog

For a selected component, the **Properties** dialog allows you to edit its properties using the **Variants** page. It shows which variants the current component is fitted in and if there are Part variants. A fundamental rule of variants is that the bare board will be constant across all variants, so all pads, tracks and copper will always appear in the plots and finished board.

Parts variants allows you to have more than one component instance with the same component name but **different Part or Footprint or Attribute Values** in each variant. The rule is that only one component instance of a given component name can be not-fitted in each variant.

Properties: Component - Variants

Component Nets on Pins Comp Attributes Variants Vault

Variant	Fitted	Part Name	Footprint	Attributes		Variant Description
				Category	Value	
USA*	<input checked="" type="checkbox"/>	C	C0805	Capacitor/Generic	1uF	120V variant
GB	<input type="checkbox"/>	C	C0805	Capacitor/Generic	1uF	240V variant
EU	<input type="checkbox"/>	C	C0805	Capacitor/Generic	1uF	220V variant

Each named variant is shown for the component (USA, GB and EU).

Colour coding for Properties dialog

There are a number of possible colour states to help you use the **Variant Properties** dialog:

The name of the **Variant** currently active in the design is shown in **bold** type and with an * asterisk. In the below example this would be the **USA** variant:

Properties: Component - Variants

Component Nets on Pins Comp Att

Variant	Fitted	Part
USA*	<input checked="" type="checkbox"/>	C
GB	<input type="checkbox"/>	C
EU	<input type="checkbox"/>	C

The red line indicates the currently selected row for editing, it does not indicate the current variant.

The row(s) for the component instance(s) represented by the symbol or footprint currently selected in the design are shown highlighted in blue text.

If the component instance(s) selected is not fitted, it is shown in light grey.

Component Nets on Pins Comp Attributes Variants Vault

Variant	Fitted	Part Name	Footprint	Attributes		Variant Description
				Category	Value	
USA*	<input checked="" type="checkbox"/>	C	C0805	Capacitor/Generic	1uF	120V variant
GB	<input type="checkbox"/>	C	C0805	Capacitor/Generic	1uF	240V variant
EU	<input type="checkbox"/>	C	C0805	Capacitor/Generic	1uF	220V variant

Instances that share the same symbol or footprint currently selected in the design but have different Attributes or Parts are shown in green text. If you change the variant to a different one, the 'other' component instance will now be highlighted green (as it is different to the current variant).

Instances that use a different symbol or footprint to the one currently selected in the design are shown in a darker grey. This overrides the green colour if the Part or Footprint are different to the selected variant.

The example below shows the GB Variant as the current variant. The USA version has a different Attribute value so is highlighted green and the EU variant has a different Part Name so is highlighted dark grey.

Variant	Fitted	Part Name	Footprint	Attributes		Variant Description
				Category	Value	
USA	<input checked="" type="checkbox"/>	C	C0805	Generic/CA	1uF	120V variant
GB*	<input checked="" type="checkbox"/>	C	C0805	Generic/CA	2uF	240V variant
EU	<input checked="" type="checkbox"/>	C 1.0pF	C	Generic/CA	3uF	220V variant

Display of Variants

The display of your variants can be controlled in a number of ways:

Through the Variants Manager

Within the **Variants Manager** you can opt to display **Not-Fitted Components** (as well as plot or not plot them within a Schematic design, shown in the dialog below).

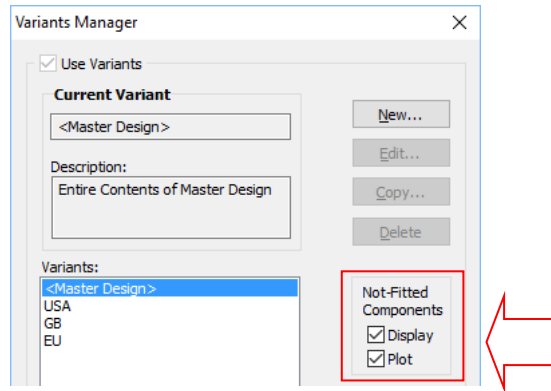

In Schematics, Not-fitted Components/Gates together with any connections to their pins are not displayed (unless the **Display Not-Fitted Components** option in the **Variant Manager** has been enabled).

Technology Layer Class

Within the **Technology Layer Class**, the check box **Comp. Items Visible In All Variants** can also be selected to control the display of variants on particular layers. All items with an electrical layer class will continue to be displayed even when the component is Not-fitted. By default, all other 'not electrical' items will not be displayed for Not-fitted components, e.g. Silkscreen shapes, although this can be changed by checking the **Comp. Items Visible In All Variants** option for the appropriate Layer Class. (As with Schematics, the **Display Not-Fitted Components** option provides a global override to force Not-fitted components to be always displayed.)

It may be that you wish to see (and plot) variant detail on one layer but not another, such as on an Assembly layer specific to one variant but not on another that doesn't require it.

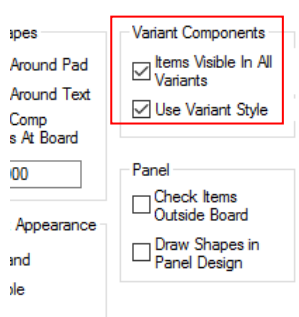

If a shape is visible when Not-fitted, it can be drawn with the **Design Settings, Variant Style** by selecting the **Use Variant Style** option.

Colours used for Variants

Within the **Colours** dialog and **Highlights**, there are two available colours for use with **variants**. One is for **Variants** and the other for **Not Fitted**.

Name	Displayed	Colour
Attached Dimensions/Callouts	<input type="checkbox"/>	
Branch Point Via	<input type="checkbox"/>	Blue
Bus Tracks	<input type="checkbox"/>	Green
Clearances		Orange
Component Pad 1	<input type="checkbox"/>	Grey
Differential Pair Path	<input type="checkbox"/>	Yellow
Differential Paired Tracks	<input checked="" type="checkbox"/>	Olive
Highlight		Orange
Highlight 'Fail'		Red
Highlight 'Pass'		Green
Highlight 'Unchecked'		Grey
Highlight 'Warning'		Orange
Locked Track Segments	<input type="checkbox"/>	Yellow
Marked Net	<input type="checkbox"/>	Blue
Not Fitted	<input checked="" type="checkbox"/>	Blue
Online DRC		Pink
Selection		Green
Signal Paths	<input type="checkbox"/>	Cyan
Star Point	<input type="checkbox"/>	Blue
Sub Nets	<input type="checkbox"/>	Grey
Test Points (All)	<input checked="" type="checkbox"/>	Yellow
Test Points (Top)	<input checked="" type="checkbox"/>	Red
Test Points (Bottom)	<input checked="" type="checkbox"/>	Green
Unconnected Pads	<input type="checkbox"/>	Grey
Unfinished	<input type="checkbox"/>	Pink
Variants	<input checked="" type="checkbox"/>	Olive
Weld Spot		Grey
Weld Spot (Direct Hit)		Green

The **Not Fitted** colour can be used to highlight not-fitted components that are still visible. It is best used in conjunction with the **Display Not-Fitted Components** option in the **Variants Manager** dialog.

The **Variants** colour can be used to highlight any component that participates in design variants with either a **Not-Fitted** or **Part Variant** status change.

Line Styles used in Not-Fitted Components

It is possible to specify a line style to be used for drawing any shapes that are still visible for not-fitted components. This may be set within the Design Settings dialog under **Defaults - Variant**. Select the **Line Style** required. The line style is used in conjunction with the **Display Not-Fitted Components** option to provide the desired effect.

Fitted Component Variants

The **Fitted** column shows you whether the component is fitted or not in the design in a particular variant (components are fitted in all variants by default).

Variant	Fitted	Part Name	Footprint	Attributes		Variant Description
				Category	Value	
USA*	<input checked="" type="checkbox"/>	C	C0805	Capacitor/Generic	1uF	120V variant
GB	<input type="checkbox"/>	C	C0805	Capacitor/Generic	1uF	240V variant
EU	<input type="checkbox"/>	C	C0805	Capacitor/Generic	1uF	220V variant

A component cannot be Not-fitted if any other property has been modified, such as it having a different Part, Footprint or Attribute.

Part Variants

As well as the more simple fitted or Not-fitted status, Pulsonix can also cater for more advanced variant conditions of Parts. Part variants can include different Parts for the same component as well as different Footprints or Attributes. For example, you may wish to have a completely different Part with a different symbol or footprint; this can be positioned and connected independently. Alternatively, you may want the component to have different attributes, but still be represented by the same physical symbol or footprint.

Variant	Fitted	Part Name	Footprint	Attributes		Variant Description
				Category	Value	
USA	<input checked="" type="checkbox"/>	C	C0805	Generic/CA	1uF	120V variant
GB*	<input checked="" type="checkbox"/>	C	C0805	Generic/CA	2uF	240V variant
EU	<input checked="" type="checkbox"/>	C 1.0pF	C	Generic/CA	3uF	220V variant

To make changes to the **Part Name** or **Footprint** or an **Attribute Value**, you can either double-click on the Part Name field or Footprint of the Variant you wish to change.

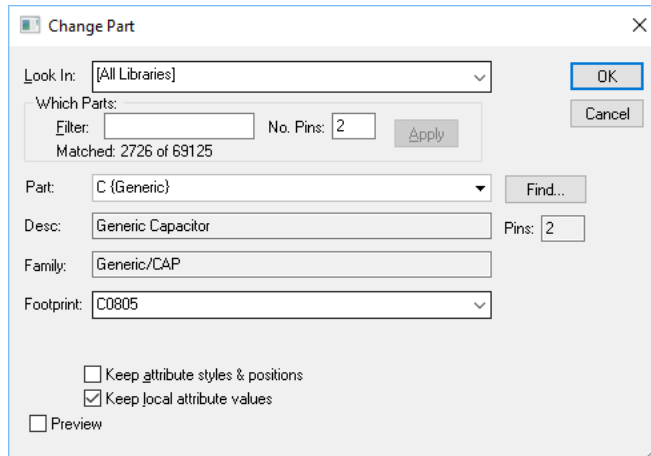

Alternatively, right click on the **Part Name** or **Footprint** cell and choose the **Change Part** option from the context menu. This will present you with the Change Part dialog (as above):

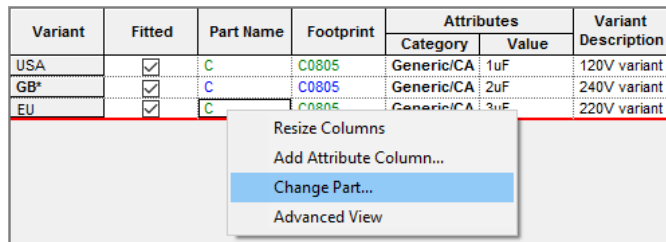

To change an **Attribute Value**, double-click on the **Attribute Value** name and type the new value required.

Variant	Fitted	Part Name	Footprint	Attributes		Variant Description
				Category	Value	
USA	<input checked="" type="checkbox"/>	C	C0805	Generic/CA	1uF	120V variant
GB*	<input checked="" type="checkbox"/>	C	C0805	Generic/CA	2uF	240V variant
EU	<input checked="" type="checkbox"/>	C 1.0pF	C	Generic/CA	3uF	220V variant

Component Variant Attributes

As an aid to identifying the component instances displayed in the design, there are a number of Attributes specific to Variants that can be added to the Component symbol or footprint:

Use the **<Component Variant Id>** where your component has different instances of the same component. It may be that the Part and Footprint are the same but the Value attribute changes. This unique identifier means the instance can be identified.

A **<Current Variant>** attribute can be added to the symbol or footprint, this will display the name of the 'Current' variant selected in the design.

The **<Current Variant Description>** is extracted for the current variant if it has been defined within the Variant Manager.

You can also assign a **<Fitted In>** attribute to a symbol or footprint definition. This will display all variants the component instances represented by the symbol or footprint are fitted in. The variants in which the symbol or footprint represent a different component instance (because this has a different Part or Attribute) are shown at the end enclosed in brackets, for example, *first_variant,(second_variant)* i.e. USA,(GB,EU)

These attributes can be added to the symbol or footprint definition using the **Insert Attribute Position** option. This will display the appropriate 'Attribute' for the component instance the symbol or footprint represents in the current variant.

Variant Attributes

Variants Text

The ability to add text, specific to particular design variants is supported in the form of variant specific design level attributes.

► To use text variants

1. Create a design **Variant** using the **Variants Manager** and switch to the required variant.
2. In the design, add your text and position as required.
3. Select the text and select **Properties**. On the **Variants** tab, select whether that text string will be **Present** or not in a selected variant. A description of the variant is also displayed for confirmation.

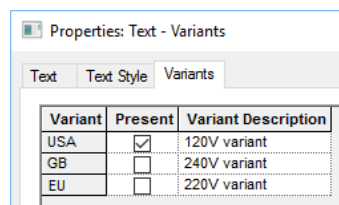

Variants Text Callouts

Text Callouts can be defined as variant specific also. To do this, as with a text variant described above, selected the Text Callout and select the **Properties** dialog and **Variants** tab. Select the check box to show whether the callout is **Present** or not in that variant.

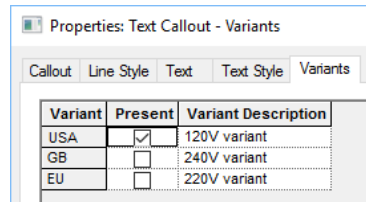

Text Callouts for variants can be used in conjunction with variant specific attributes or text too to make them more meaningful.

Text callouts that reference variant design attributes using attribute substitution will also not display or plot for variants in which the attribute is not present.

Design Variant Attributes

An additional **Variant Attributes** tab on the **Design Properties** dialog under the **Edit** menu allows design attributes to be enabled/disabled for the defined variants in a Schematic or PCB design or Profile.

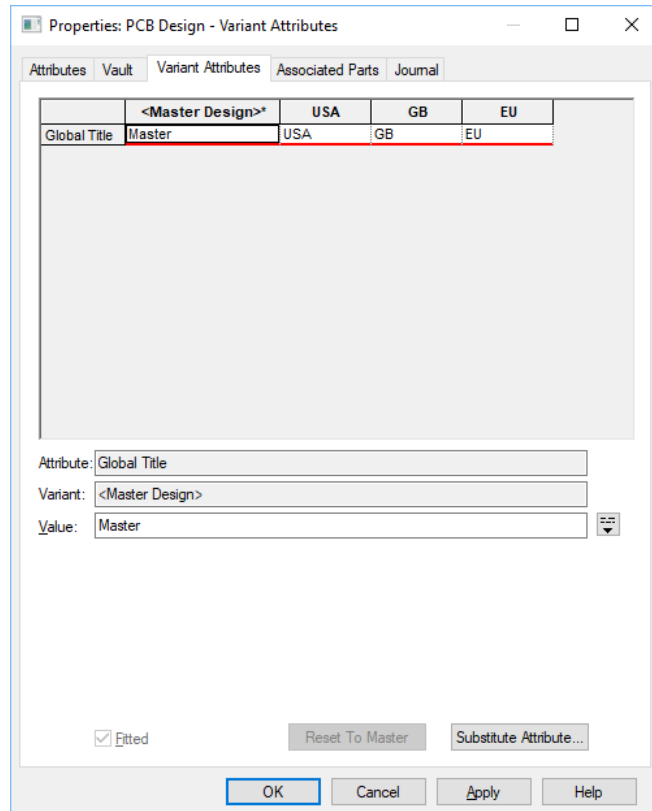

To use **Variant Attributes**, the attribute name must first be defined in the **Design Properties** dialog under **Attributes**.

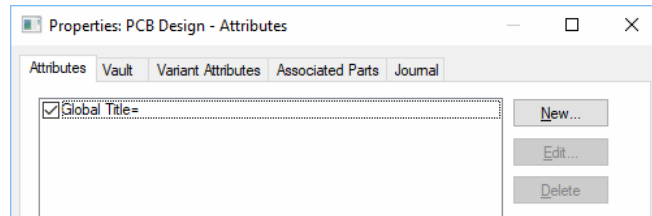

This would be defined as an attribute with no value. The value is then edited within each of variants available.

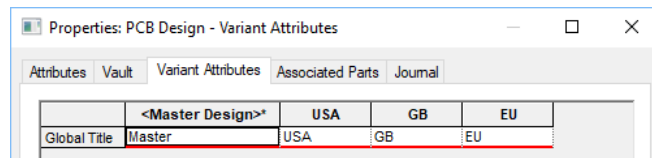

For each selected Attribute in each variant, the **Fitted** status can also be defined.

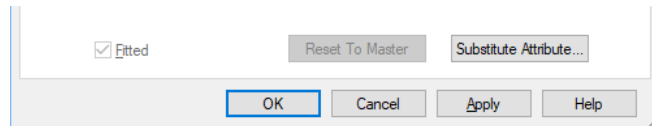

Variant Doc Shapes

You can have **Variant Doc Shapes**. A doc shape is added to the design and then using **Properties** of the shape, you can define which **Variant** the shape is fitted in.

This is a PCB only feature and is not available in Schematics.

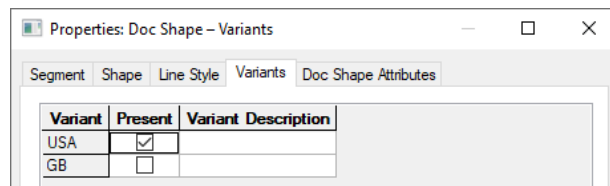

Using the Database with Part Variants

When using Part Variants, instead of using the regular **Insert Component** option, you can alternatively use the **Database Connection** cost option and specify variants from this instead.

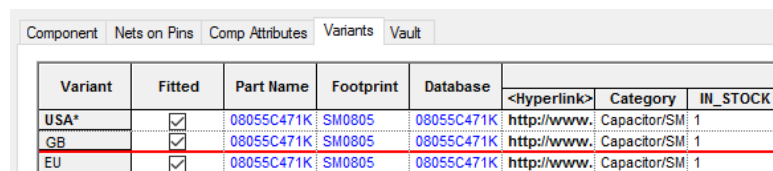

The **Database** field is now available (as the Part was taken using the Database Connection option). Changing Parts, Footprints or Attributes is pretty much the same as if using just Parts except the

information is extracted from the Database Change Part option is a field needs to be different for a different variant.

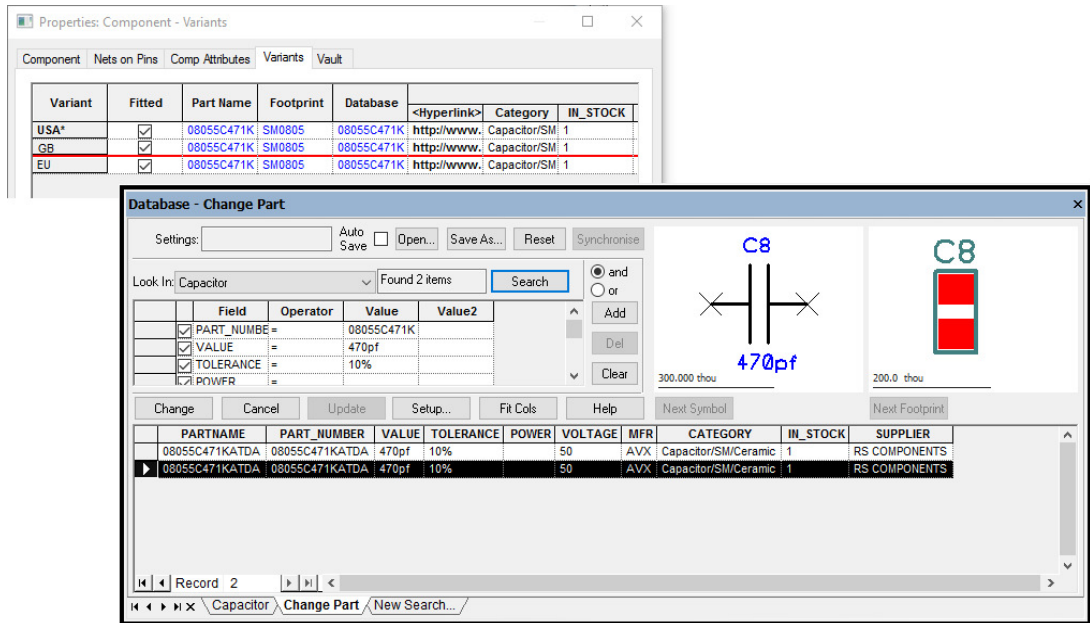

If the Part Name is changed for a variant, unless it is chosen via the **Database Browser** method (shown below), any existing database information will be lost and it will revert to being a 'local' component for that variant. For a 'local' component, the database column will be blank.

Other considerations for Variants

Plotting Variants

If variants are being used in a design, the **CAM Plot** tab of the **Generate Plot** and **Technology** dialogs will display an additional column; **Variant**.

This defines the particular variant for which each output will be produced. This may be a named variant or <Master Design> in which case the output will be produced for the entire design independent of any particular variant. It may also be set to **Current Variant** in which case the output will be produced for the variant that is selected as 'Current' at the time the plot is run.

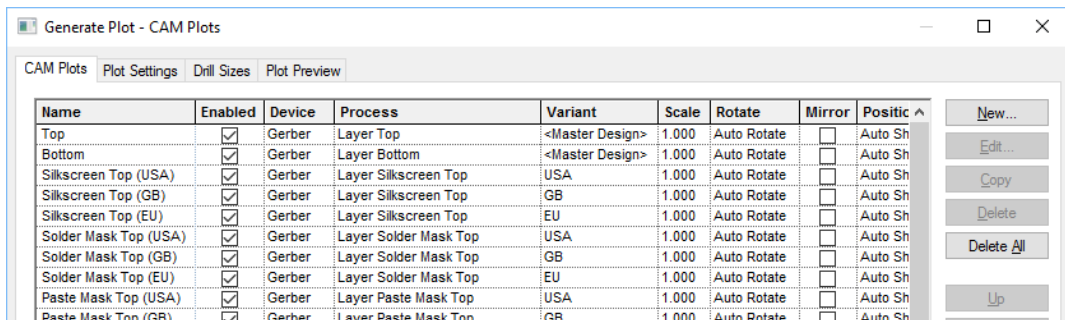

The **CAM Plot Wizard Output** page also allows specification, if necessary, of the variant for which the plot is to be produced.

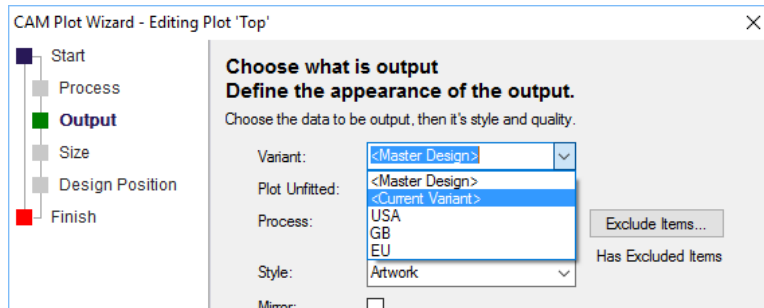

The **Auto Generate CAM Plot** dialog has an additional option **Generate For Each Variant** which, when checked, will create a plot per defined variant, for each process type that is affected by variants. By default in PCB, this will be the non-electrical layers and in Schematics will be each page in the design.

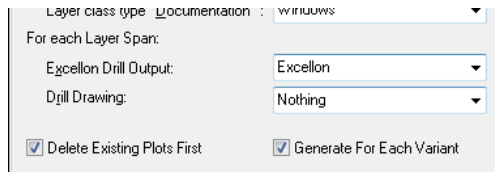

The information included in each plot will be affected by the selected variant and the Components not fitted in that variant. In PCB, the Component items plotted are determined by the layer class of each item with electrical items, such as pads, always included, whereas other items, such as silkscreen shapes, are excluded although this can be changed by checking the **Visible In All Variants** option for the appropriate layer class. The items included in plots are not affected by the **Display Not-Fitted Components** option that applies to screen display only.

If variants are in use in a design, a CAM/Plot report will show the name of the variant for which the plot was produced.

Translate to PCB

All variants information defined in a Schematic design will be automatically transferred to the PCB design when the **Translate to PCB** facility is used.

Synchronise

Synchronise Designs will additionally check and update all variant information as necessary.

Optimise Gates

The **Optimise Gates** feature in Schematics is variant-aware in that a gate will only be moved to another component if it is fitted and Not-fitted in exactly the same variants.

Design Rules Checking

Design Rule Checking is variant-aware in that certain types of spacing errors that would otherwise be reported are suppressed if the components involved are never fitted in the same variant. The spacing rules affected are component-to-component, pad-to-pad and drill-to-drill. Obviously, where different Parts or footprints are used on a component in different variants, these are also considered and checked.

Associated Parts

The **Associated Parts** tab in the **Design Properties** dialog will reflect the design's 'Current' variant. Quantities of associated Parts added for components that are Not-fitted in the current variant will not be included. Additional quantities of Associated Parts added directly in to the design will be included in all variants.

Quantities of Associated Parts relating to Not-fitted Parts will also be excluded from the Parts List Report.

Auto-Rename

The **Auto-rename** option is variant-specific. If a design has a 'Current' variant, Not-fitted components will be excluded from the rename.

Copy and Paste/Duplicate

Copying Not-fitted components will retain the Not-fitted information only for named variants that already exist in the destination design. Duplicate operations take place within the scope of a single design so duplicated components will always preserve the not-fitted state of the original but it does not retain the instancing.

Variants Report

There is a **Variants Report** supplied within the standard **Outputs** menu, **Report** option. This basic report lists all variants and Fitted or Not-fitted components in the design in a grid format.

Report Maker Files and Variants

Reports created using the Report Maker option can be variant specific by using the Variants commands available, such as List of Variants, Set Variant and If “Is Fitted”.

Using 'Instances' for Variants

Instances for variants are hidden unless you wish to display and use them. You would use Variant instances for example when a Component Variant has the same part and footprint but a different Attribute. When creating a report, you would then need to identify the instance using that Attribute Value. This would be done using the unique instance identifier.

To enable Instances, right click in any of the cells within the **Component Properties Variants** page or **Component Variant Spreadsheet**, then choose **Advanced View** from the context menu.

Variant	Fitted	Part Name	Footprint	Database	Attributes	
					Category	Value
USA*	<input checked="" type="checkbox"/>	C1812	C1812		Generic/SM	
GB	<input checked="" type="checkbox"/>	C Polarised	CPOL			
EU	<input checked="" type="checkbox"/>	C 1.0pF	C			

Resize Columns
 Add Attribute Column...
 Change Database Part...
Advanced View

Once this option has been selected, the view now shows **Attribute** and **Instance** identifiers.

Component: C1 Update Spreadsheet Discard Changes

Variant	Fitted	Part Name	Footprint	Database	Shared Identifier		Attributes	
					Attributes	Instance	Category	Value
USA*	<input checked="" type="checkbox"/>	C1812	C1812		c	c	Generic/SM	
GB	<input checked="" type="checkbox"/>	C Polarised	CPOL		b	b	Generic/CA	22pf
EU	<input checked="" type="checkbox"/>	C 1.0pF	C		a	a	Generic/CA	1.0pF

Variants Spreadsheet Editor

You can view and edit variants in a spreadsheet style interface. The **Component Variant Spreadsheet** is available on the **Edit** menu in both the Schematic and PCB design editors.

Component Variant Spreadsheet

Name	USA*	GB	EU
C1	C1812	C1812	C1812
C2	C1812	C1812	C1812
C3	C	C	C
C4	C	C	C
C5	C	C	C
C6	C	C	C
C7	C	C	C
C9	08055C471KATD	08055C471KATD	

OK
Apply
Cancel
Copy
Paste

No Variants:
Not Fitted:
Shared:
Different Attributes:
Different Instance:

The bottom half of the dialog contains the edit pane for the component variant:

Component: C1 Update Spreadsheet Discard Changes

Variant	Fitted	Part Name	Footprint	Database	Attributes	
					Category	Value
USA*	<input checked="" type="checkbox"/>	C1812	C1812		Generic/SM	
GB	<input checked="" type="checkbox"/>	C Polarised	CPOL		Generic/CA	22pf
EU	<input checked="" type="checkbox"/>	C 1.0pF	C		Generic/CA	1.0pF

Attributes:
Add Column...
Delete Value
Revert Value
Column Visib

Description:
 Part
 Variant

Component Listing

The top section is the component variant spreadsheet, with a row for each component and a column for each variant in the design.

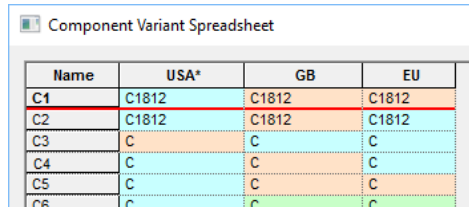

Name	USA*	GB	EU
C1	C1812	C1812	C1812
C2	C1812	C1812	C1812
C3	C	C	C
C4	C	C	C
C5	C	C	C
C6	C	C	C

Cells are colour coded to show the state of each component in a particular variant. The colour indicates whether the component is not fitted, is a different part, uses different attribute values or uses a different physical appearance. This makes the spreadsheet ideal for quickly viewing which components in the design use variants and which are not fitted in certain variants. The colour key coding can be changed using the buttons to the right side of the dialog.

Component Edit Pane

The bottom section of the dialog is occupied by a grid showing the variant details for the component currently selected in the top portion of the spreadsheet.

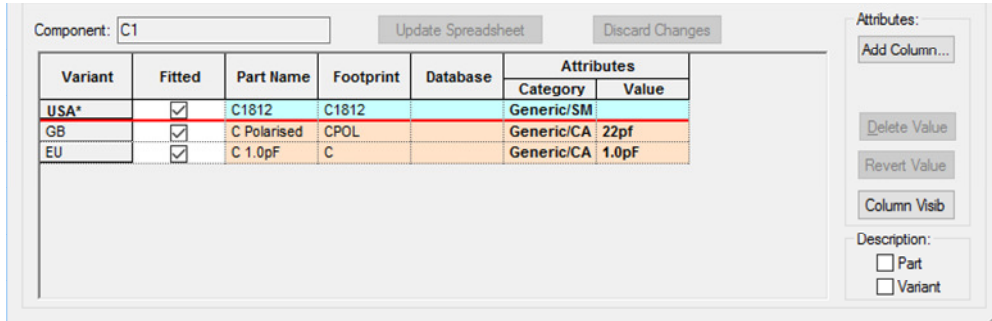

Variant	Fitted	Part Name	Footprint	Database	Attributes	
					Category	Value
USA*	<input checked="" type="checkbox"/>	C1812	C1812		Generic/SM	
GB	<input checked="" type="checkbox"/>	C Polarised	CPOL		Generic/CA	22pf
EU	<input checked="" type="checkbox"/>	C 1.0pF	C		Generic/CA	1.0pF

This is similar to the **Component Variant Properties** dialog for a selected component but with extra controls for adding columns and managing values. It contains a row for each variant in the design and columns allowing you to change the components variant state.

Cells in these columns are coloured depending on their 'state' using the same system as the spreadsheet. The name of the variant currently active in the design is shown in **Bold** text and with an asterisk * in the appropriate row. The table can be enlarged to show more variants.

Micro-vias and Layer/Component Span Technology

For Micro-vias to be created, the individual facets must be created in the correct order to enable subsequent processes and particular information defined. .

Mainly, you must have two suitable layers defined that have **Can Have Associated Layers** enabled and the same facing directions (**Top Facing**, **Bottom Facing** etc.). Once in the **Layer Spans** dialog, this will now produce the correct type of layer span when created.

Micro-via Layer 'Facing' Switch

The **Top** or **Bottom Facing** switch in the **Layers** dialog (**Technology**, **Layers**) with **Can Have Associated Layers** checked, is used to define a Micro-via layer. For a Via Span to be a Micro-via type, it must have two 'same' facing sides. So for example, L2 and L3 must both be defined as facing the same way (Top or Bottom Facing). These must be defined before it can be considered as a Micro-via when creating your Layer Spans.

Name: Inner 2	Electrical Details:
Used: <input checked="" type="checkbox"/>	Routing Bias: Y
Class: Electrical	Power Plane Ng
Type: Electrical Physical Copper Layer	
Layer Association:	Construction Details:
<input checked="" type="checkbox"/> Can Have Associated Layers	Material:
<input checked="" type="radio"/> Top Facing Side: Inner	<input type="checkbox"/> Thickness: 0.0001
<input type="radio"/> Bottom Facing (Mirror Components)	Embedding: None
<input type="checkbox"/> Allow Normal Components	
<input type="checkbox"/> Allow Buried Components	
<input type="checkbox"/> Allow Micro-via Stop Pad Either Side	

When using Micro-vias, the 'Facing' direction must also be defined if the layer is to be used as a **Stop layer** in the layer span definition, Stop pads are described a bit further on.

Allow Micro-via Stop Pad Either Side

A check box on inner electrical layers, **Allow Micro-via Stop Pad Either Side**, allows you to create micro-vias onto the electrical layer from above or below, regardless of the facing value of this layer. You should only use this if you really know what you're doing and following consultation with your manufacturer. This feature is described further in the online help under *Technology Layers*.

Layer Spans

For Micro-vias, once at least two layers have been defined using the same **Facing** switch, then the Layer Span can be created. **Layer Spans** are defined in the **Layer Spans** dialog from within the **Technology**. It is from here you can define layer spans to use for Vias, Micro-vias, Board Outlines, Areas and Components.

A layer span becomes a **Micro-via** type by having the same **Facing** side on its Top and bottom **Layers** as we said already. To use a micro-via technology you should define the span between **same facing layers**.

	Name	From Layer	To Layer	Type
Y	<Through Hole>	<Top Side>	<Bottom Side>	Through Hole
Y	T - L2	<Top Side>	<Layer 2>	Micro-via - top facing
Y	L2 - Core Top	<Die Top Cor	<Layer 2>	Micro-via - top facing
Y	Core Top - Core Bottom	<Die Top Cor	<Die Bot Core>	Buried
Y	Core Bottom - L3	<Layer 3>	<Die Bot Core>	Micro-via - bottom facing
Y	L3 - Bottom	<Layer 3>	<Bottom Side>	Micro-via - bottom facing

Layer Spans are created as you would normally using the **Layer Span** option from the **Technology** dialog. When a pair of layers are selected which have the same facing layers, the **Type**: is automatically changed to a **Micro-via**, this also shows the via 'drill' direction.

Name: Inner 2 > Die Core Top	Type: Micro-via - top facing
Used: <input checked="" type="checkbox"/>	
From Layer: <L2>	
To Layer: <Die Core Top>	

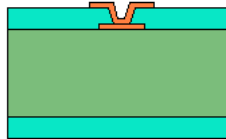

Composite Micro-via Layer Spans

Composite Spans are used for connecting multiple layer spans together. So for example, you could span Top to L2 and L2 to L3 using two individual vias. Because Micro-vias would require these to have the same coincident ‘drill’ points for laser or plasma drilling, the most effective method of moving these would be as a set moving as one unit. A composite span will allow this to happen but it must be defined for use.

A **Composite Layer Span** can be defined using a combination of **Micro-via** and **normal spans**. It is specifically used for creating a via ‘stack’, or more correctly, a Micro-via stack. That is, a stack of vias which together complete the span and which move together as one unit, this will usually involve a set of Micro-vias and sometimes includes a buried via.

Defining the Composite Spans

To do this, you must first define each span within the composite. Once created, define the **Composite Layer Span** by selecting layers from **From Layer:** and **To Layer:** using the drop down list. If these are legal layers which can create a composite span. The **Composite Layer Span** check box will be available.

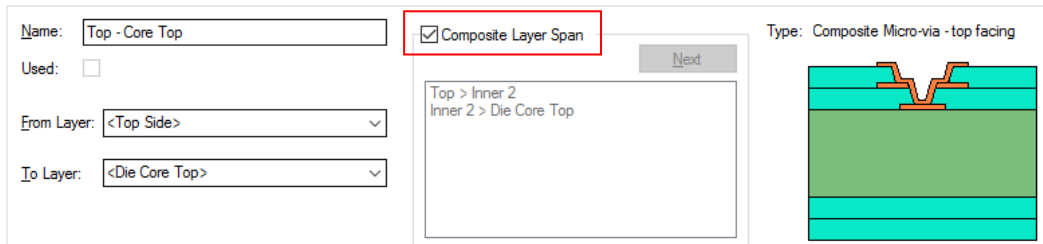

The dialog will offer each possible combination of spans which will cover this composite overall span (if there is more than one, press **Next** to cycle through each one). You can change a composite back to a normal span by unchecking the **Composite Layer Span** check box.

Once you have a composite span defined, you must then define the **Pad Style** (this will be your via) to use on each via in the stack. Only nets which have composite styles defined in the **Net Styles** dialog can use the composite span to create stacked vias.

Defining a Composite Via Span in Net Styles

To use a **Micro-via layer span** or **Composite layer span**, you will require an entry in the **Net Styles** for a net within your **Technology**. When composite spans are used it causes a via stack to be added rather than a single via, each via in the stack using the pad style defined in the net styles entry.

Attribute: <Net Name> For Nets of Type: <Any>

Match: SDI* Within Areas:

Define Default Track Styles

For Tracks:

On Side: <Any>
or
On Layer:

Default Track Style:

Name: Signal (6)
Width: 0.1524

Alternate Track Style:

Name: Signal (6)
Width: 0.1524

Fatten/Neck Min Length: <Default>

Define Via Defaults

For Vias with Layer Span: Top > Die Core Top

Vias Not Allowed

Define Via Protection: Delete if not Routed Reduce Span

Define Default Via Style

Layer Span	Via Style
Top > Inner 2	Via 400 120
Inner 2 > Die Core Top	Die Pad

Using Composite Layer Spans

Composite via stacks can be added using **Insert Via**, or added automatically by changing layers of tracks. If using **Insert Via**, then the same restrictions to the function will apply as when using **Insert Multiple** e.g. no finish markers, test point or design clearance etc.

Selecting a via selects all the vias in that stack, and the status bar informs you of this and the layers it spans.

All Vias In Composite Layer Span: Top - Inner 2 Net: \$\$\$0014

This is so the stack can be moved as one, but the individual vias in the stack can still be selected using the **Select Next** option. Once a via has been moved away from the rest in the stack, the stack is no longer complete and will not be selected as one item (as a composite).

Composite span stacks can be shown in the **Layer Stack Preview**, and in the **3D Viewer**.

Stacked and Tapered Micro-vias

By defining a **Layer Span** between **two same facing layers**, vias using this span are defined as a **Micro-via**. To add extra detail to your Micro-vias, you can define the via (in **Pad Styles**) as having an **Entry Pad** and/or **Stop Pad**.

Entry Pads and Stop Pads

There are two special **Pad Style** exceptions (defined in the **Technology**) for **Micro-via Entry Pad** and **Micro-via Stop Pad**. These define the pad sizes used on the entry and stop layers when the style is used for a Micro-via (unless there is an explicit exception for that layer, which will be used instead). These provide a simple method of defining specific Entry and Stop pad sizes, **they are not mandatory for Micro-vias**.

This pad definition is used for creating 'tapered' Micro-vias, where the Entry and Stop pads are different diameters to match the 'taper' effect caused by the laser drilling.



A Micro-via showing a tapered hole

It is also possible to create a set of ‘stacked’ Micro-vias using a **Composite Layer Span**. Without Stop pads, the laser will simply ‘cut’ to a depth or until it reaches a Stop pad. Multiple ‘tapered’ via spans are also possible using **Composite Layer Spans** using different **Via Pad Styles**.

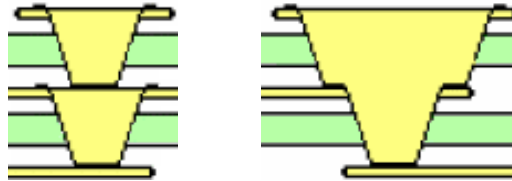

Two examples of Stacked Micro-vias (Composite)

Creating Entry and Stop Pads

► To create entry and stop pads

1. In the **Technology** and from within **Pad Styles**, use the **By Layer** option for a selected pad. Select the pad that requires the entry and stop pad definition.
2. For **Type**: select **Micro-via Entry** from the drop down list.
3. The **Layer**: box will now be greyed out as un-selectable.
4. Type a value for **Width**: if it needs to be different to the default stack value and then press **OK** to exit and save the exception.

Name:	Via 400 120	Shape:	Type: Round
Used:	<input type="checkbox"/>	Width:	0.4000
Exception Type:	Micro-via Entry Pad	Length:	0.4000
	By Layer	Offset:	0.0000 0.0000
	Spacing Shape		
	Micro-via Entry Pad		
	Micro-via Stop Pad		

5. Normally, you would also do the same for the **Stop Pad** so the laser knows where to enter and where to stop drilling, although this isn't mandatory for some processes.
6. The Stop pad is displayed as a solid pad even though the default pad stack is defined with a drill hole. The Entry pad is displayed with a drill hole shown (this is controlled on the Layer Class settings).
7. The **Pad Style** entry for that pad would then look like this for example (shown for **Via 400 120**):

Y	Via (60)	Round	1.5240	0.8128	<input checked="" type="checkbox"/>
Y	Via 400 120	Round	0.4000	0.1200	<input checked="" type="checkbox"/>
	<Micro-via Entry Pad>	Round	0.4000		
	<Micro-via Stop Pad>	Round	0.3000		
Y	Via 500	Round	0.5000	0.2000	<input checked="" type="checkbox"/>

Name:		Via 400 120	
Used:		<input checked="" type="checkbox"/>	
For Use By:		<input type="checkbox"/> Through Hole Pads <input type="checkbox"/> Surface Mount Pads <input type="checkbox"/> Vias <input checked="" type="checkbox"/> Micro-vias	
Shape:		Type: Round	
Width:		0.4000	
Length:		0.4000	
Offset:		0.0000 0.0000	
Drill:		Shape: Round	
Width:		0.1200	
Length:		0.0000	
Inner Diameter:		0.0000	
Offset:		0.0000 0.0000	
Rotation:		0.0	
Plated Through:		<input checked="" type="checkbox"/>	

Outputs for drilling Micro-vias

Micro-vias are 'drilled' (using a laser or plasma 'drilling' machine), an output is exported from Pulsonix using the standard **Excellon NC Drill** format. Special customised reports can be generated using the **Report Maker** option on the **Outputs** menu if required. All pad styles on any layers and the drill position can be output if required, there are special Report Maker commands to allow this.

Advanced Technology Features

Autorouting

Pulsonix supports a number of Autorouters for automatically routing your design, these are described in the Online Help supplied with the product.

Interactive High Speed Design

An additional cost option to allow you to interactively route the design using High Speed design rules. This option is described in the *Interactive High Speed Users Guide* supplied as a PDF file and available from within Pulsonix under the Help menu and Online Manuals>

Chapter 7. Outputs For PCB Manufacturing

Overview of manufacturing outputs

Pulsonix provides you with an output mechanism for generating professional PCB layout plots for manufacturing. The plot types available will cater for home production of PCBs, right through to professional fabrication facilities.

All the plot and drilling outputs are located in the **CAM/Plot** option on the **Output** menu. From this option you can select the layer, or combinations of layers to plot, the scale, the rotation, the position on the plot and the 'machine' driver.

From this option you can output:

- Gerber 274-D, 274-X (extended Gerber format) and X2 format photo-plots
- PDF Files for documentation purposes
- Numerically controlled drilling (NC Drill) files
- ODB++ format
- HPGL Pen plots
- Windows printer plots using any installed Windows driver
- IPC-2581, IPC-356 format files
- JTAG files
- Format files created in the Report Maker option, such as BOMs, Pick & Place, Flying Probe etc.
- STEP, DXF and IDF format files
- SVG graphics format
- Other formats can be exported if you have an appropriate license

Plot types

Plots are available for all aspects of the design but because Pulsonix uses a configurable output mechanism, it means that any plot required can be generated:

- Top, bottom and inner electrical signal layers
- Silk screen layers
- Solder resist plots
- Solder paste masks
- Copper and power plane (full or split) layers
- Assembly and manufacturing drawings
- NC Drilling and profiling/routing files
- Back Drilling drill files
- Drill drawing layers containing Drill letter, Symbol
- Inner layer embedded component layers
- Embeddd Views

The CAM Plot option

Using the CAM/Plot option

Use the **CAM/Plot** output option to export your design to manufacturing files. This option is available on the **Output** menu. It provides you with a mechanism of generating different types of plots using one dialog. It also provides you with a process that can be saved to be used over and over again from a single button press.

The **CAM/Plot** setup parameters are saved to the **Technology** dialog under the CAM/Plot tab. This means that different designs using the same plotting parameters can be defined and reused. The plotting mechanism uses items within the design and on particular layers to create the contents of the plot. The **layers** are controlled by the **Technology** file and the **Layer Classes** within it.

Outputting a plot overview

The process for creating specific types of plots is covered in this chapter. The description below is the 'fast-track' to outputting a plot.

Once the **Auto Generate** dialog has been used, the bulk of the work to create a plot has been done other than any 'fine tuning'. The **Auto Generate** dialog has been designed so that any rotation, any scale plot to fit is specified by default. This means the plot will fit the paper if the **Run** button is pressed. Obviously, you can use the CAM/Plot dialog to redefine the plot as required.

► To output a plot

1. The plot type should be defined in the **CAM/Plot** dialog.
2. The correct printer or plotter should be specified in the **Settings** dialog.
3. Check that the plot is as required using the **Preview** dialog and select the plots required using the **Enabled** check boxes.
4. Check that the plot fits the plot area or 'bed'.
5. Press the **Run** button.

Outputting a Windows Print to File and PDF

Pulsonix supports standard Windows printers. This means your plots can be sent to any device that Windows supports, such as a laser printer, PDF file or a Windows print File (Postscript for example). As well as Windows 'printers', Pulsonix also has its own built-in PDF driver which can be directly selected as an output device type, the same as you would for Gerber, Excellon, Windows etc.

Auto Generate Plots

If the parameters are not available the first time you try and enter the CAM/Plot option (or the first time you enter **Technology** and the **CAM/Plot** page) you are presented with a dialog to request auto-generation of the parameters. This is a smart system that matches the class of layer with a potential plot type. So, for example, an Electrical Layer class such as Top Copper, would be plotted to Gerber. These plots can be changed at any time but creating them using this mechanism gets you started very quickly. You can still generate additional plots outside of this mechanism if you require using the **CAM Plot wizard** once in the plotting dialog.

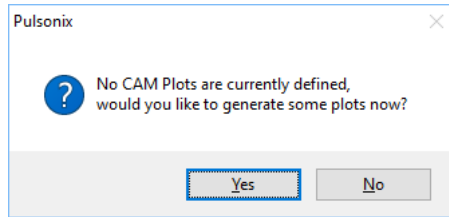

If you click **No** to this, the CAM/Plot mode is entered but you will need to create the parameters manually. If you click **Yes**, the **Auto Generate CAM/Plots** dialog is displayed:

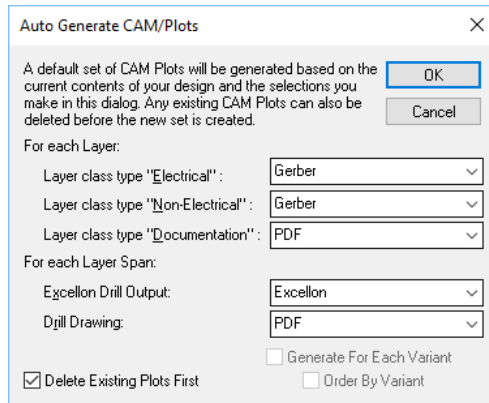

Once in the **CAM/Plot** dialog, you can create other plot or output types. For non-plot outputs, such as IPC-2581 or DXF etc. you will probably use the CAM Plot Wizard.

The CAM/Plot dialog

Overview

The dialog itself has four pages available through the tabs **CAM Plots**, **Plot Settings**, **Drill Sizes** and **Plot Preview**.

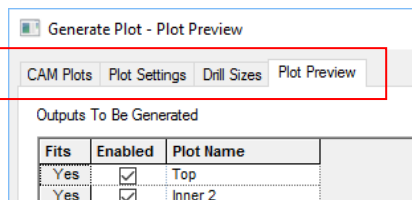

CAM Plots is used to set up the characteristics (or rules) of the plot, the scale, rotation, plot type etc.

Plot Settings is used to set up the plotter or printer being used. This dialog also contains a location for the destination of the plot output if a file is being output.

Drill Sizes is used to set up drill holes, drill letter association, drill symbol association and suchlike, all facets used for drills holes. It also enables you to define drill sizes and tolerances available.

Plot Preview is used to display a preview of the final plot. This should provide you with an indication of what the plot will look like before it is plotted or printed. It is not a 100% 1:1 representation showing everything on that layer.

The **Preview** window displays the plot selected in the list. It shows two main boxes (shown with a centre 'cross' in each to help identify the centre of the plot). The first is the plot bed (the paper extents or the bed size), this is the larger box shown in **Red**. The second box is the design extents shown in **Blue**. Also shown is the board outline and elements of the design to give you an indication of the orientation and the scale relative to the paper. The preview window can be switched off by deselecting the **Preview Design** check box.

All other information shown in this dialog is confirmation of the **CAM Plots** dialog settings, such as the Scale, Mirror and Rotated status of the design.

CAM Plots

The **CAM Plots** dialog is used to set up the plot for output and how the plot will appear on the output driver plot 'bed' being used.

If a regular plot is required, the plot can be almost completely defined using the **Auto Generate** dialog when you first enter the option. The Auto-generate option can also be run to regenerate the plot settings automatically. Some plots may in fact be totally auto generated using this option. The only setting you may need to adjust is the plotter type for a PDF output or the Exclusion of items not required in the plot.

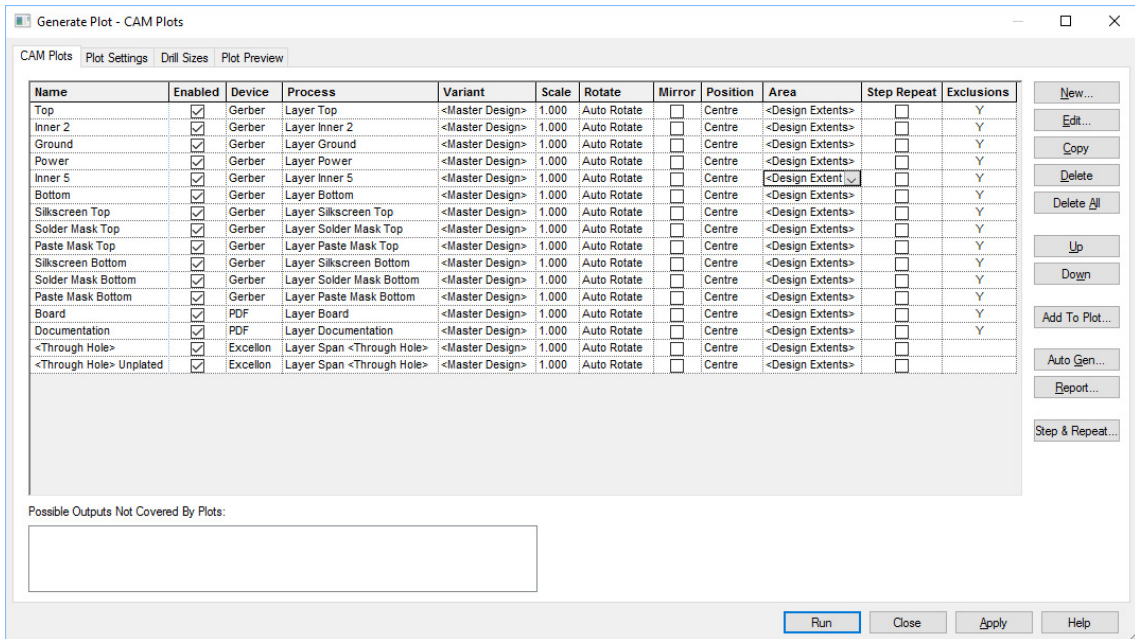

The grid matrix displays the options selected for each plot. Once created using **Auto Generate** or **New** button, you can edit the information in each row to suit your requirements.

If no plots exist or you require a new plot, you can use the **New** button which will use the **Plot Wizard** to complete this task. The wizard will lead you through the plot type generation process to create a new line in the CAM Plots table. If you have a plot selected, **New** copies the properties of this existing plot into the Plot Wizard.

After the row has been created, it can be edited interactively or by using **Edit**, but the row or item in a row must be selected first.

The **Edit** button displays the **Plot Wizard**. Each of the pages of the plot wizard will allow you to set up facets of the plot to be output. See later in this section for an overview of the Plot Wizard functionality.

The **Delete** button is used to remove any unwanted plots from the grid.

Add To Plot is used to combine plots and is more relevant to the PCB Design editor. When selected, it displays the **Process** page of the Plot Wizard from which to choose a process to add to the plot selected. The **Add To Plot** option will add the plot to any other plot selected. If it gets added to the wrong plot by mistake, select it, and use the **Delete** button to remove it. The plot must then be recreated with the correct plot type selected first.

If when you started the **CAM Plot** option, you selected **No to Auto Generate** the plot type, you may now use the **Auto Generate** option to create a set of plots ready for use. This can be an alternative to using the **New** plot option but will create a full set of plots for the design, replacing any existing plots in the table. Use **New** if you wish to add to the existing set of plots.

The **Reports** button is used to generate a summary report of all the plots and their settings. This is in addition to any reports generated at the time of actually running the plots.

The **Step & Repeat** button allows you to panelise your designs. This is covered below.

Step & Repeat

There are two mechanisms in Pulsonix for creating ‘panelised’ designs. Which option you choose depends on what your final requirement is.

You have the **Step & Repeat** option on the **CAM Plot** dialog and a separate integrated **Panel Editor** option. This mode opens a Panel Editor application within Pulsonix from where you can do multiple processes such as add V-Score lines, test coupons or tab routs for example.

The **Step & Repeat** option on the **CAM Plot** dialog allows you to plot multiple copies of the same plot with a specific offset or defined gap between them. It also allows an overlaid plot of different colours in one plot and allows true step and repeat for the same plot by using the **Add To Plot** button and offsetting it each time. It however, doesn’t allow you to plot different PCBs or to add extra details, such as test coupons.

You must have a combination of the **Step & Repeat** criteria and you must enable each of the plot outputs to specify that this feature will be used. This is done using the **Step Repeat** check box available for each plot on the main **CAM Plots** dialog.

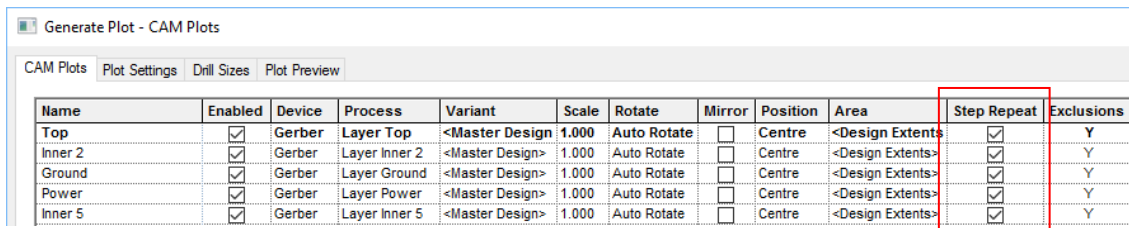

The **Step & Repeat** button opens up this dialog. From here you can define the number of copies to create on the plot for both the X and Y direction in an array. It also allows you to define the offset between each board plotted.

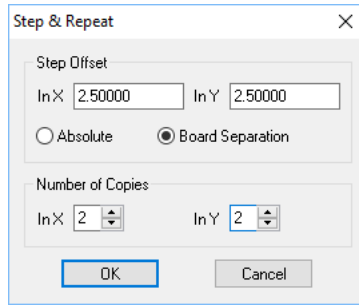

The **Step Offset** defines the distance each copy is offset from the previous one. There are separate values for X and Y. You can define the offset as **Absolute** which means that it is the total offset. Therefore an **Absolute** offset of 0 would put each copy exactly on top of the previous one (not recommended).

A **Separation** offset is the gap between copies. In PCB this is the separation between Board Outlines (if any), otherwise it is the separation between design areas. An offset of 0 would align the edges of each plot.

Number of Copies, defines the number of copies in the X & Y directions. These numbers include the original as the first copy (so they start from 1).

*Note: the offset and number of copies are defined in the X & Y directions before any rotation has been applied. The **Plot Preview** will give you an indication of how the final plot will appear.*

Plotting Variants

If your design has variants defined, an extra tab on the CAM Plots dialog allows you to specify which variant it is you wish to plot. You can use specific variants or plot the <Master Design>.

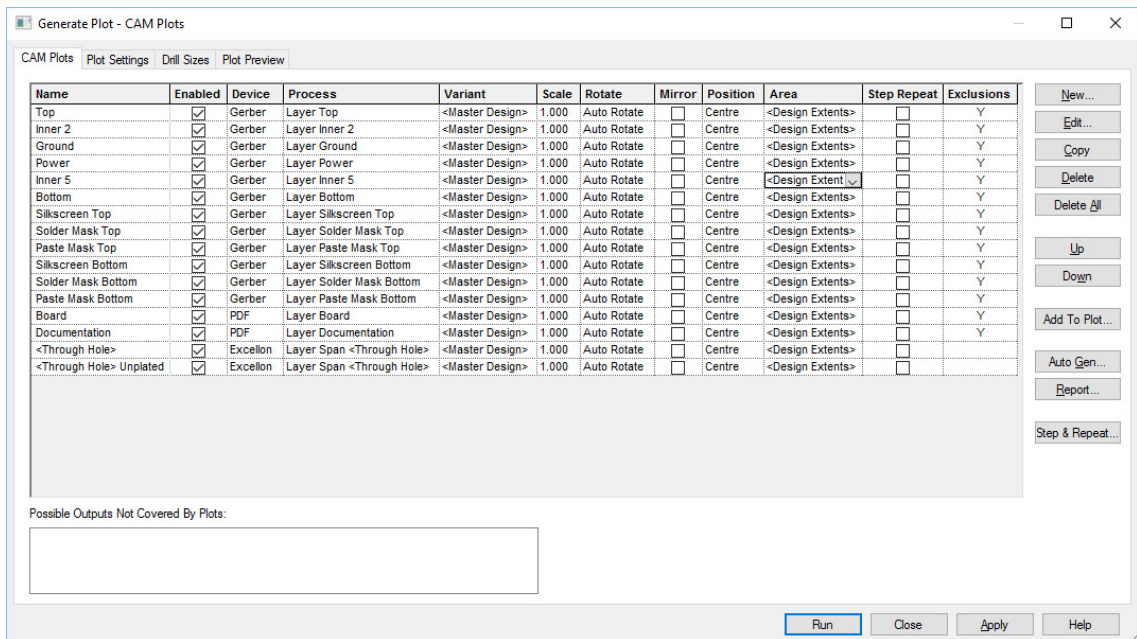

Plot Groups

You can group plots using the **Plot Group** name option. This enables sets of plots of the same type to be enabled or disabled. The **Group** column only appears if any of the plots have a group name defined.

The **Enabled** setting (box checked or unchecked) can be **applied to plots in the same group** by selecting this option from the context menu. For example, you could group plots by output device or process if you wish, i.e. Windows/Gerber etc. or Documentation/Manufacturing/Prototype etc.

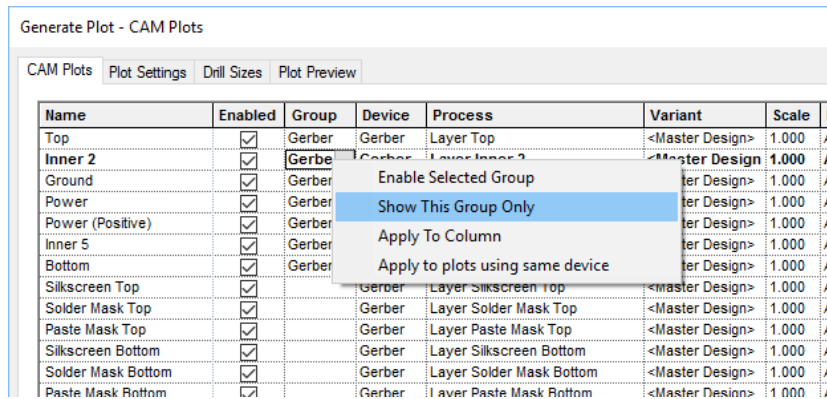

You can create a plot using the **CAM Plot Wizard** and add the plot to the **Plot Group**. Either select an existing plot group name from the drop down list or type a name in. This group can be selected by name when in the main CAM Plot dialog. If you wish to add existing plots to a group, from within the **CAM Plots** page, you can select a name from the **Group** drop down list or type a name in.

You can optionally provide a **Plot String** which is used to satisfy any Attribute Positions of type <Plot String> placed on your design. This could be used to define a reference number or other identifier on your output.

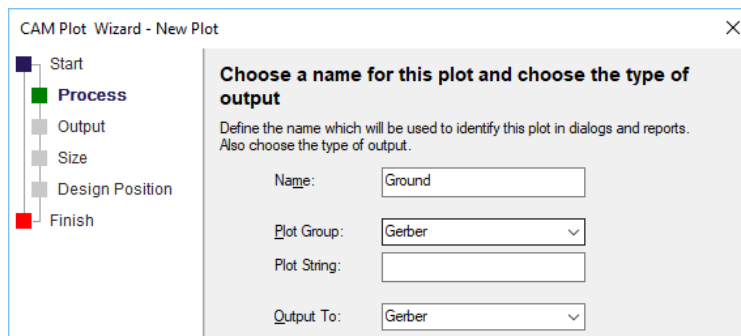

Using the Plot Wizard

The **Process** page defines the **Name** of the plot and the output type using **Output To**. This will be present all formats available for output or **Nothing**. *Nothing* would be selected if the plot type was undetermined at the time that the plot type was created.

The plot name is for reference only to identify the plot. It is recommended that you use meaningful names that help identify the plot that they represent.

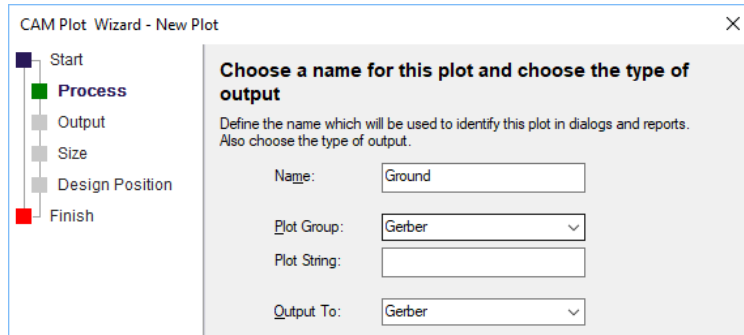

If the selection is set to **Windows**, you are presented with an extra drop down list from which to choose an alternative printer to the default Windows printer. Leave the setting to <Default Printer> if you wish to simply use the default Windows printer assigned by your system.

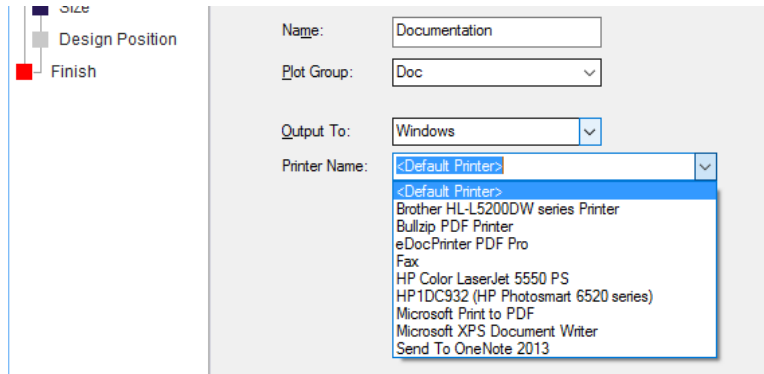

If the selection is set to one of the non-'plot' type of outputs, like DXF or IPC-2581 for example, the dialog has a Setup button. This provides you access to that formats' main setup page. This is the same as if accessed from the **Output** menu.

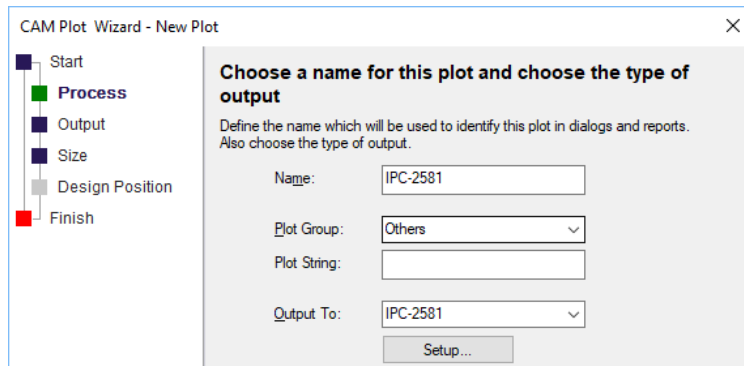

If the selection is set to **Format files**, then the extra drop down list box is presented for you to make your selection. The choice of Format files will be taken from the **Folders** dialog. You are also presented with a choice of Output Locations

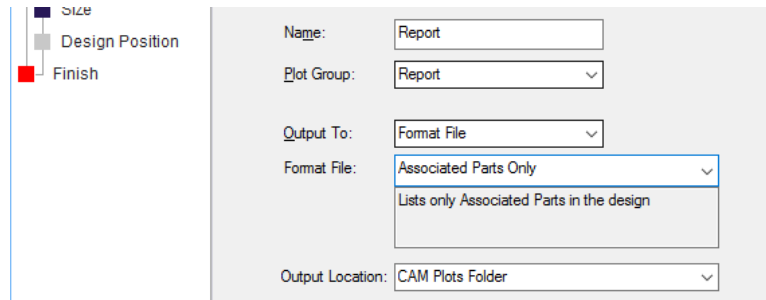

The **Output** selection is used to define the style of plot output.

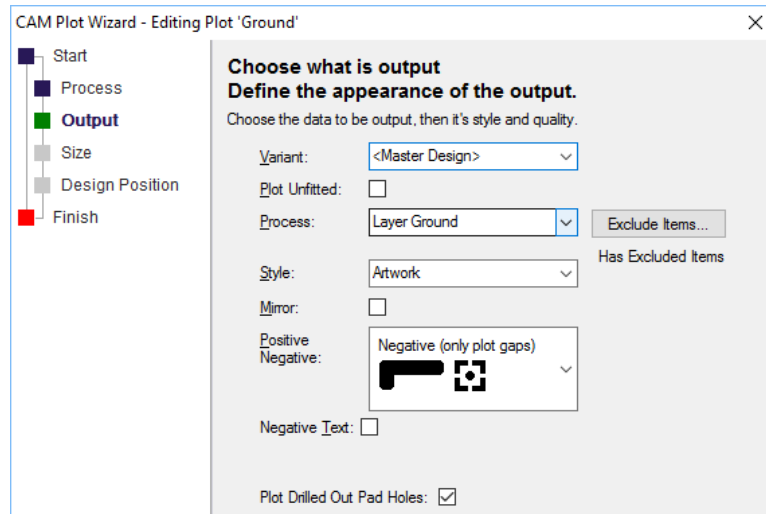

Choose the **Variant** required from the drop down list if your design has variants defined. You can also opt to

The **Process** button allows you to select the Layer or process type to be output.

The **Style** of the plot can be either **Artwork** or **Outline**. Artwork will output the true width of all items whereas Outline will only output the item as a centreline unfilled shape. The outline mode would be used for check plots, for example.

The **Mirror** check box enables you to select whether the plot is mirrored or not.

When a power plane layer is selected (the layer must be defined as a power plane in the **Layers** dialog) **Plane Style** is used to determine the style of the plane output.

The choice of Plane Style are, a **Positive (plan & items)**, a **Negative (only plot gaps)** plot, a **Negative (plot isolation)** and a **Positive (only plot items)** plot. Generally, a Negative plot is requested which produces a smaller plot file, this will be reversed electronically when plotted by the plot house. A positive plot would be used when creating a composite plot of the plane layer that has embedded tracks, this is discussed later on in this section.

Positive (plane & items)



Not available for Pen plot outputs.

Negative (only plot gaps)



Available for all plot types.

Negative (plot isolation)



Not available for Pen plot outputs.

Positive (only plot items)



Available for all plot types.

Plot Drilled Out Pad Holes - If the current plot is plotting holes in pads, normally this will be a hole in the copper land. If the land is smaller than the hole, then the land would be drilled out completely, so nothing will be output. However, with this option checked, the drill hole is output as a copper shape, the same size as the drill hole. This might be useful, if you are hand drilling the holes and need a marker. As this is a specialised use, this option is off by default.

Positive (plane & items)

This is the full power plane output with isolation gaps and embedded tracks with isolation clearances and thermal relief where connected to the plane.

Negative (only plot gaps)

This is used to produce a plot of all the oversize items in the plane, mainly for the Gerber output, to be reversed and combined with a Positive (only plot items) plot.

Negative (plot isolation)

This is used for to create the full power plane with isolation gaps, thermal relief and embedded tracks (with isolation) but in negative mode. To create the power plane from this plot, the image would need to be photographically reversed. Producing this type of plot saves printer toner and can be photographically reversed to get the plot image required.

Positive (only plot items)

This is used if the power plane contains 'embedded' tracks or items. This plot is the item itself without any isolation or thermal relief. This would be used in conjunction with the Negative (only plot gaps) plot to produce a power plane with embedded items for a Gerber plot.

From the **Exclude** button you can also select which items to exclude from the plot. If nothing is selected in this dialog, all items visible in the design are plotted.

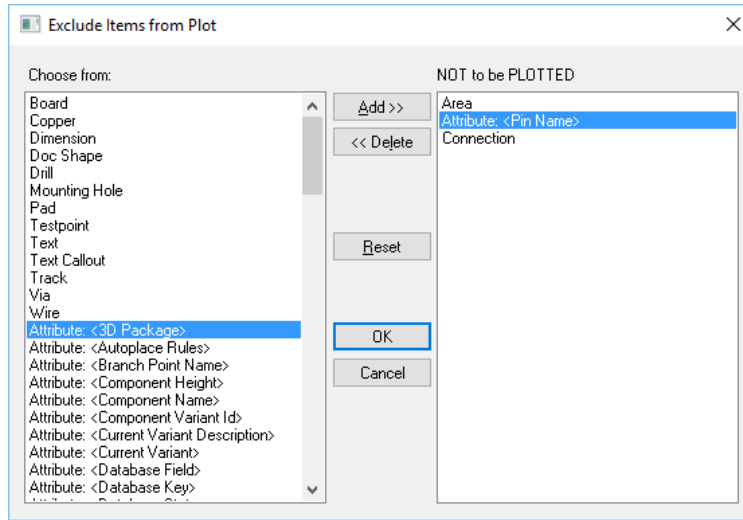

Items to be excluded are selected and added, using **Add>>**, to the right hand pain shown as **NOT to be PLOTTED**. Use **<<Delete** to remove the excluded item from the list. By default, some items are automatically excluded, appearing in this list but from which, they can be removed if required on the plot.

The **Size** page uses selections to define the **Scale** and **Rotation** of the plot.

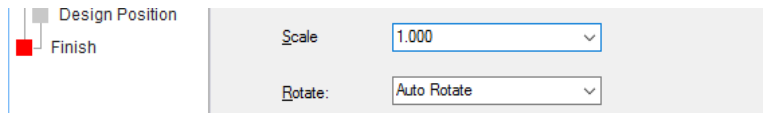

For **Scale**, the choice on the drop down list is **Auto Fit** and **1.00** (a scale of 1:1). You can also type in directly into the list to define your own scale factor to shrink or expand the plot, e.g. 5 to make it 5 times bigger or 0.5 to make it half the size.

The **Rotation** drop down list allows you the choice of **Auto Rotate**, **No Rotation** or **Rotate 90 degrees** (forcing the rotation to 90 degree from its original position).

The **Design Position** page defines the position of the plot relative to the plotter type being used.

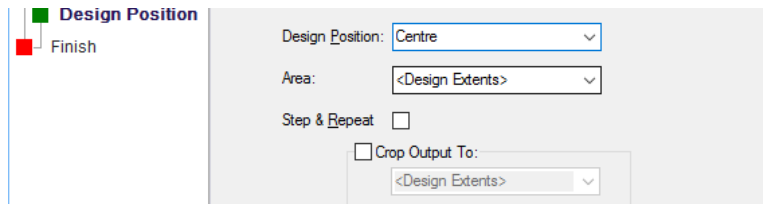

The **Design Position** provides a number of options from which to move the design on the plot. This design location specified is aligned with the location on the paper or plotter table, and specified in the **Registration Point** which is set in the **Settings** tab for each device driver. This allows accurate and repeatable registration of plots to be achieved if the correct combination of values is chosen.

For example, if both **Position** and **Device Registration** are set to **Origin**, the design origin is aligned with the origin (0,0) on the plotter.

If either the **Position** specified here or the device **Registration Point** are set to **Auto Shift**, then the plot is positioned as best as possible on the output device.

The **Step & Repeat** check box will allow you specify that a plot is to be panellised. See previously in this section for a more detailed description of Step & Repeat.

Use **Crop Output To** a defined area to prevent items outside this area from being plotted. The cropping is only done crudely, so items that cross the area will be plotted. In general, this would be used for a set of items which form a coherent subset of the design which you would want to position within the overall plot.

The **Finish** page provides you with a summary of the options selected in the Plot Wizard.

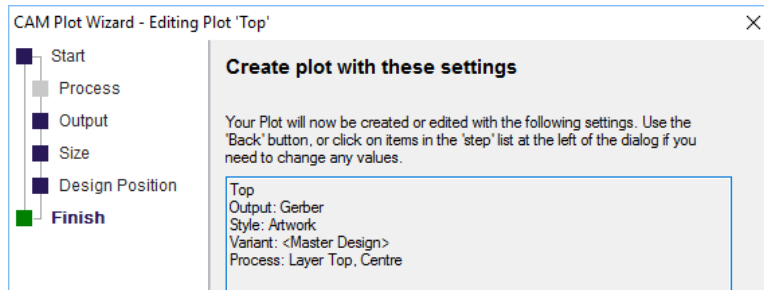

Once the **Finish** button is pressed, the plot type is generated and added to the plot grid. If you decide to change any of the settings, you can go back to the page directly or by using the **<Back** button to move back through each page in sequence.

Plot Settings

Plot Settings is used to set up the printer/plotter and the location of the files output.

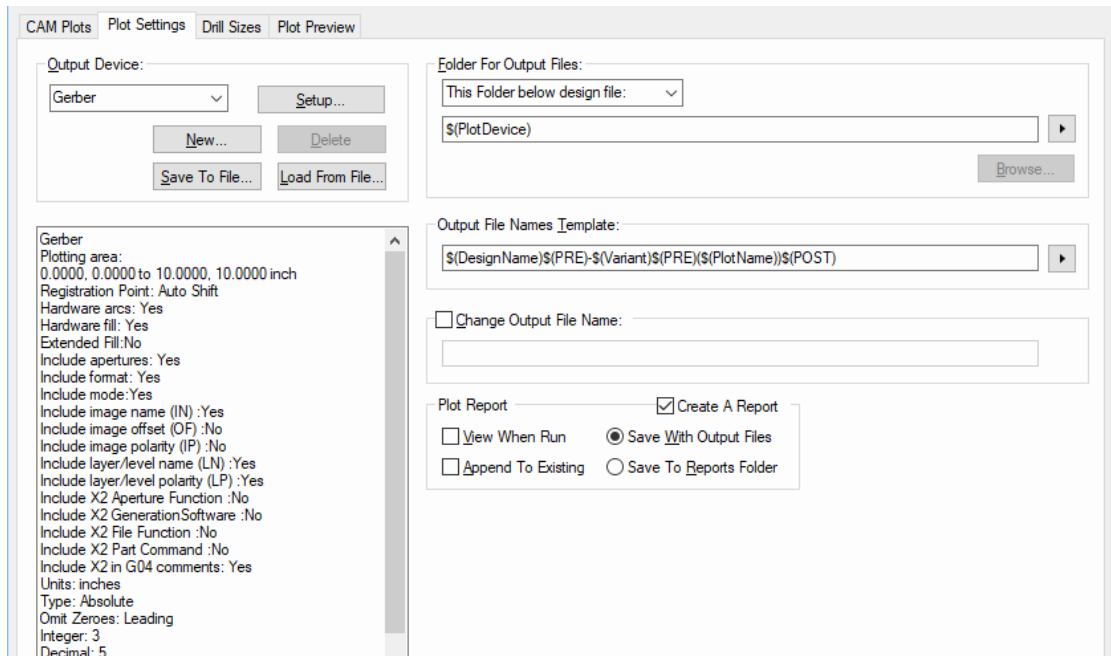

From the **Output Device** section of the dialog, you can view and change the settings for each kind of output device available. Use the drop-down list to choose the output device you wish to look at, and the current settings will be displayed in the large text area below.

If you wish to change any of these settings, press the **Setup** button to access the Setup dialog for the output device shown. The actual dialog displayed is different for each kind of output device (Windows, HP-GL Pen etc.). You can also Save and Load configuration files (**Save/Load To File**) for each of these device types. For example, if you have one plot setting for Gerber 274-D and one for 274-X, you can define these and save the settings for reuse.

Options on the right side of the dialog allow you to define where the plots are saved to and how the plot names will be formatted.

Drill Sizes

The **Drill Sizes** button enables you to setup the drill table to associate drill letters with particular drill sizes, these appear on a drill drawing and drill table in the design. A **Drill Drawing** is produced by plotting a **Layer Span** to a ‘drawn’ output device (such as Windows or Gerber output).

The Drill Table

This page allows you to view the drill sizes used in the design, and assign a string identifier and shape to the drill for use with a drill drawing.

Generate Plot - Drill Sizes

CAM Plots Plot Settings Drill Sizes Plot Preview

Used	Diameter	Plated	Id	Symbol	Symbol Size	Symbol Filled	Count	Min Diam	Max Diam	Description
	0.200	Y	H	Round	0.200	<input checked="" type="checkbox"/>	0			
Y	0.254	Y	G	Round	0.254	<input checked="" type="checkbox"/>	6			
	0.610	Y	A	Round	0.610	<input checked="" type="checkbox"/>	0			
	0.762	Y	E	Round	0.762	<input checked="" type="checkbox"/>	0			
Y	0.889	Y	B	Round	0.889	<input checked="" type="checkbox"/>	83	0.813	0.889	
Y	1.067	Y	C	Round	1.067	<input checked="" type="checkbox"/>	9			
	1.143	Y	I	Round	1.143	<input checked="" type="checkbox"/>	0			
	1.270	Y	D	Round	1.270	<input checked="" type="checkbox"/>	0			
Y	2.000	Y	F	Round	2.000	<input checked="" type="checkbox"/>	5			
	2.540	Y	J	Round	2.540	<input checked="" type="checkbox"/>	0			

Drill Sizes:
Tolerance: 0.000 Step: 0.100 Define Allowed Sizes 4 Allowed Sizes

Drill Id
Text Style: TextStyle35.0-3.0

Offset
X 0.00000 Y 0.00000
 Relative to right edge of symbol

Length Units
 Imperial: thou
 Metric: mm
Name: mm
Precision: 3
 Trailing Zeros Rounding Indicator (+/-)

Reset
Rename All
Report...

Run Cancel Apply Help

There will be an entry for each drill referenced by the **Pad Styles** defined in the **Technology**. Plated and unplated drills are counted separately. The drill is marked as Used if the drill actually appears in

the design (not just in the technology). Subsequent columns define how the drill should appear on a drill drawing.

The **Id** is a string which will be shown alongside the position of the drill. The string does not have to be unique and can be empty if no identifier is required. The text style used for this string is defined in the **Drill Id Text Style** control.

The **Symbol** is a shape which will be shown at the position of the drill. It can be any of a number of predefined shapes and is created at the size (width/diameter) specified in the **Symbol Size** column. The size can be 0 if no symbol is required. The symbol can be filled or unfilled according to the value in the **Symbol Filled** column. For some shapes the filled value is not relevant.

Drill Sizes and ID

The information contained under the Drill table relates to how the drill letters and symbols will be presented in the plot.

The **Allowed Drill Sizes** feature allows you to define a list of drill sizes. This is useful if your manufacturing process only allows a specific limited set of hole sizes to be drilled.

Press the **Define Allowed Sizes** button to define this set. All drill sizes must match sizes from this list. Any which do not match are drawn in red in the drill list. For a drill size to match it must be in the range [**Allowed Drill Size - Step - Tolerance** to **Allowed Drill Size + Tolerance**], if there is more than one match, the smallest is taken. The **Step** and **Tolerance** can of course be 0, forcing an exact match.

For example, if the allowed drill sizes were 18, 19, 23 with step 2 and tolerance 0.1; actual drill sizes of 15.9, 16.5, 18 would match 18; sizes of 18.2, 19.1 would match 19; 15.8, 20 or 23.2 would not match any allowed size and would be drawn in red in the table.

Manufacturing Outputs

This section details the creation of specific types which may be required for manufacture. These plots may not always have been setup initially with the design or may not be available in the Technology file used, so this section will describe the steps you need to follow to set them up.

Creating the plot types

Essentially, plots are controlled by a number of factors, all of which can be defined in Pulsonix allowing you to create the required plot. Because Pulsonix uses design items to create the plot, if it exists in the design then it can be plotted.

How are the plots controlled?

The contents of plots are controlled from with the **Technology** file using the **Layers** dialog and **Layer Classes** within it. These technology items control any layer information and layer plot information for the design that uses them.

	Name	Associated Layer	Class	Side	Bias	Net	Ma
		Paste Mask Top	Paste Mask	Top	None		
		Solder Mask Top	Solder Mask	Top	None		
Y	Top		Electrical	Top	X		
Y		Silkscreen Top	Silkscreen	Top	None		
		Wires Top	Wire Link	Top	None		
	GND		Electrical	Inner	Power Pla	0VDIG	
	+5V		Electrical	Inner	Power Pla	5VDIG	
Y	Bottom		Electrical	Bottom	Y		
Y		Silkscreen Bottom	Silkscreen	Bottom	None		
		Solder Mask Bottom	Solder Mask	Bottom	None		
		Paste Mask Bottom	Paste Mask	Bottom	None		
		Wires Bottom	Wire Link	Bottom	None		
	Documentation		Documentatio		None		
	Construction Lines		Documentatio		None		

Where a specific plot type is required you should create a layer in the Technology file that will be used when outputting the plot layer.

By default, the Technology files supplied with Pulsonix already have 'standard' manufacturing layers setup within them. If you import a design from another system and elect not to use one of these Technology files during import, you will need to add the additional layers before generating the manufacturing plots.

Not only does the layer need to exist but the **Layer Class** must also contain the correct setup required for that layer. This ensures that items will exist on the layer so that when plotted they appear on the plot!

For this purpose, you should create named **Layer Classes** that can be used for each layer type created.

Name:

Used:

Layer Type: Essential For Manufacture

Pad Oversize: <input type="text" value="0.0000"/> <input checked="" type="radio"/> Absolute Size <input type="radio"/> Percent of Pad Size Min Undersized Pad: <input type="text" value="0.0000"/> <input type="checkbox"/> Board Visible <input type="checkbox"/> Merge Cutouts	Pad Types: <input checked="" type="checkbox"/> Component Pads <input type="checkbox"/> Doc Symbol Pads <input checked="" type="checkbox"/> Bgnd Pads <input type="checkbox"/> Free Pads <input type="checkbox"/> Mounting Holes <input type="checkbox"/> Comp Mount Holes <input type="checkbox"/> Vias <input type="checkbox"/> Micro-vias	Pad Condition: <input checked="" type="checkbox"/> Surface Mount Through Hole: <input type="checkbox"/> Plated <input type="checkbox"/> Non Plated <input type="checkbox"/> Only If Testpoint <input type="checkbox"/> Exception Only Draw/Plot Appearance <input checked="" type="checkbox"/> Pad Land <input type="checkbox"/> Drill Hole	Areas Visible Component <input checked="" type="checkbox"/> Body <input checked="" type="checkbox"/> Clearance <input checked="" type="checkbox"/> Others Design <input checked="" type="checkbox"/> Design Board Cutouts <input type="checkbox"/> Unplated <input type="checkbox"/> Plated	Break Shapes <input type="checkbox"/> Break Around Pad <input type="checkbox"/> Break Around Text <input type="checkbox"/> Break Comp Shapes At Board Gap: <input type="text" value="0.0000"/>	Layer Mask Min Mask Width: <input type="text" value="0.0000"/> Min Mask To Track: <input type="text" value="0.0000"/>	Variant Components <input type="checkbox"/> Items Visible In All Variants <input type="checkbox"/> Use Variant Style	Panel <input type="checkbox"/> Check Items Outside Board <input checked="" type="checkbox"/> Draw Shapes in Panel Design
---	--	---	--	--	--	---	---

To use this dialog, you must create a **Class Name** first to identify the Layer Class. The **Layer Type** will define the way in which the layer class is used, and by default, has default settings.

On non-Electrical layers (Electrical, Construction and Documentation layers are pre-defined), you can control what types of Pads will be displayed and plotted using **Pad Types**. This is used in conjunction with the **Pad Condition** and **Pad Appearance** sections to customise which Pads are displayed and plotted, and how they are plotted.

For non-Electrical layers, using **Pad Condition** you can control which Pads are plotted according to the type of pad. So you can choose to plot Surface Mount pads by checking the **Surface Mount** check box, or you can **ONLY** plot pads which are Testpoints by checking the **Only If Testpoint** check box.

For non-Electrical layers the **Pad Appearance** will enable you can choose to plot the **Pad Land**, its **Drill Hole**, or both, subject to the conditions specified.

The **Areas** check boxes are used for selecting whether **Component** areas or **Design** areas are enabled in the view and plotting of the design.

Break Silkscreen is used to break the Silkscreen over holes and vias to stop the silkscreen paint going down the hole. You select from the two specific options – **Break Around Pad** and **Break Around Text**. The **Gap** between the item and the hole can also be defined using the current design units.

The picture below shows the effect of break silkscreen:

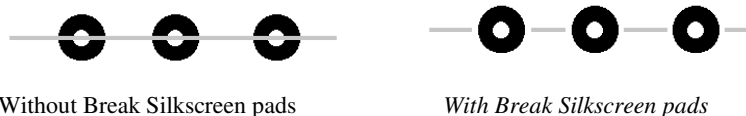

For pad items to be plotted, the pad item must be enabled on the Layer Class dialog. This also applies to the **Board Outline** that will not be plotted on a particular layer unless enabled on this dialog.

Plots are created and generated from within the **CAM/Plot** option. Items not required can be excluded and the plot 'crafted' using scale, rotation and mirroring to fit the plot bed.

These features are discussed below as they are used.

Types of manufacturing plots

Top/bottom electrical layers

The Top and Bottom layer plots, sometimes referred to as Component and Solder layers are generally the most basic type of plots. Unless very specific plots are required, they can be generated using the **Auto Generate** option with almost no additional interaction.

Generally, electrical plots of the Top or Bottom layers will be created to include all electrical items, such as pads, vias, tracks, copper, copper text etc., which are also subject to the **Design Rules Checks**. Unless you have excluded any items using the **Exclude** option within the **CAM/Plot Wizard**, all electrical items defined on these layers (and defined in the Layer Class) will be output. The **Exclude** option acts as an over-ride to the settings in the layer class.

As most designs will have at least one layer, a Top or Bottom or both, then the Technology file will already have the minimum required to generate the electrical plots.

With a Layer Class of an **Electrical** type, the **Pad Type** and **Pad Condition** are fixed. Layer types of **Electrical** are always displayed and hence available for plotting. The only items that are optional for your selection are the **Board Outline** and **Drill Hole** appearance. The Drill Hole appearance is a user preference but the board outline may need further consideration. If you enable Board Outline, it will appear output on all plots that use this Electrical Layer Class name, this might not be what you really want and an alternative method of adding this is available. A more detailed discussion on adding the board outline to a plot, is given below.

Adding the board outline to plots

Board outlines can easily be added to plots. There are two methods available for including the board outline depending on how you decide to setup the system.

The default method as supplied with the default **Technology files** is to include the display (and hence, plotting) of the board outline in the **Layer Class** definition. This is also the default setting when using the **Reset To Default** button.

Using the **Board Outline** visibility switch in the **Layer Class** means that any Layer definition that uses this layer class will have the board outline plotted (unless you exclude it from the CAM Plot dialog).

The second method is to create a separate layer that displays the board outline. The board outline exists on all layers in the design, again, its display and plotting is controlled through the Layer Class. A new layer class would need to be created. The contents of this new layer class would need to reflect the display of the board outline only. All Pads and Vias would be invisible (not selected), as would Pad Appearance. The **Layer Type** would need to be **Non-Electrical**.

Name: Reset To Default
 Used:
 Layer Type:

Pad Oversize:

 Absolute Size
 Percent of Pad Size

Min Undersized Pad:

Pad Types:
 Component Pads
 Doc Symbol Pads
 Bgnd Pads
 Free Pads
 Mounting Holes
 Comp Mount Holes
 Vias
 Micro-vias

Pad Condition:
 Surface Mount
Through Hole:
 Plated
 Non Plated
 Only If Testpoint
 Exception Only
Draw/Plot Appearance
 Pad Land
 Drill Hole

Areas Visible
 Component
 Body
 Clearance
 Others
 Design
Board Cutouts
 Unplated
 Plated

Break Shapes
 Break A
 Break A
 Break C Shapes
 Gap:
Variant Con
 Items Vi
 Variants
 Use Var

Board Visible
 Merge Cutouts

A new layer on the **Layers** page would also need to be created which uses this new layer class.

	Name	Associated Layer	Class	Side	Bias	Net	Material	Thickness
	Board Outline	Board Outline	Board Outline	Top	None			0.00
Y	Silkscreen Top	Silkscreen	Silkscreen	Top	None			0.00
Y	Top	Electrical	Electrical	Top	X		Copper 1oz	1.38
	Solder Mask Top	Solder Mask	Solder Mask	Top	None		Mask (0.025)	0.98

Name:
 Used:
 Class: New Class...
 Type:

Electrical Details:
 Routing Bias:
 Power Plane Net:

Layer Association:
 Associated With:
 Side:

Construction Details:
 Material: New Material...
 Thickness:
 Embedding:

Usually Plotted
 In Layer Stack Preview

To use this new layer, you will need to combine this with other plots to include the board outline. From with the CAM / Plots option, you will need to use the **Add Plot** option to add the Board Outline layer to other plots. Plot combining is described in more detail below.

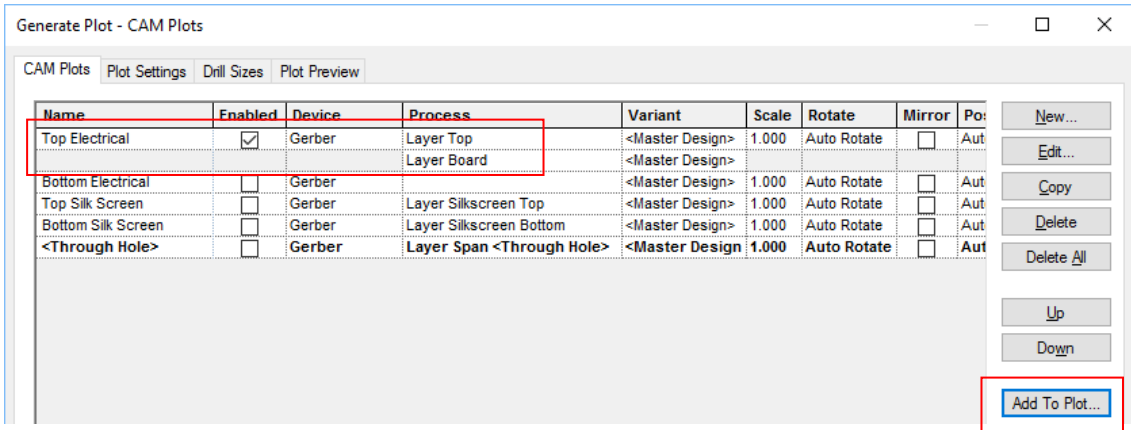

Creating Silkscreen layers

Silk screen layers are **non-electrical** layers which appear on the **Top** or **Bottom** layers of the design. By default, the supplied Technology files are setup to include a Top and Bottom silk screen layer which use the **Silkscreen** layer class.

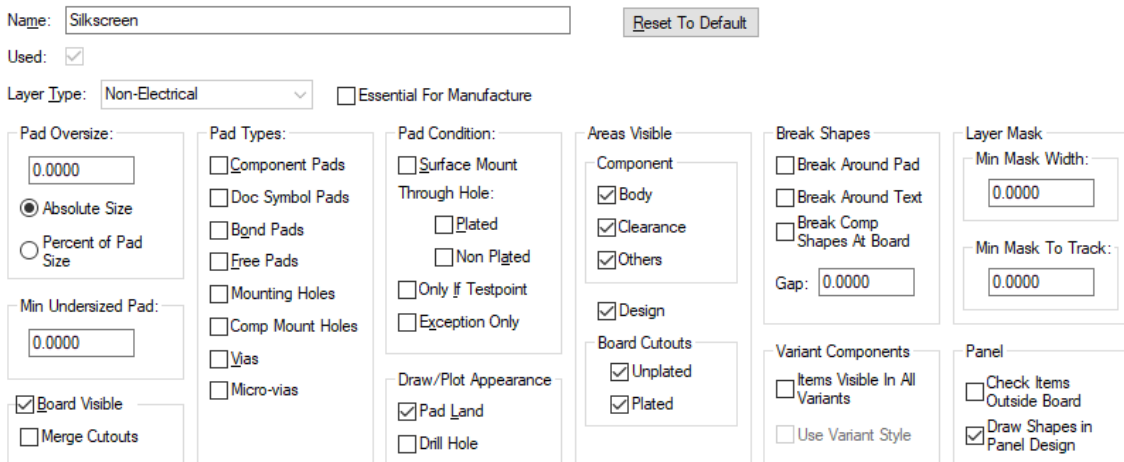

The default Silkscreen layer class excludes all pads and vias but includes the board outline, although this isn't always required.

If the Technology file does not contain a Silkscreen layer this can be added using the **Layers** dialog in the **Technology** option. This layer should contain a Layer Class that restricts the display and plotting of the pads and vias.

Break Silkscreen is used to break the Silkscreen over holes and vias to stop the silkscreen paint going down the hole. You select from the two specific options – **Break Around Pad** and **Break Around Text**. The **Gap** between the item and the hole can also be defined using the current design units.

As with the electrical layers, the **Auto Generate** option will generate both the Top and Bottom Silkscreen layers automatically if they don't already exist in your Technology file.

Creating Solder resist masks

Solder resist masks are used on the Top and Bottom layers to ‘mask’ the electrical layers when using a soldering process (automatic or manual). To ensure that only items that require solder are exposed, a mask is made of the outer layers. This mask is made up of the plated through holes and surface mounted pads including vias, Doc symbols, mounting holes and free pads.

Name:

Used:

Layer Type: Essential For Manufacture

Pad Oversize: <input type="text" value="0.0000"/> <input checked="" type="radio"/> Absolute Size <input type="radio"/> Percent of Pad Size Min Undersized Pad: <input type="text" value="0.0000"/> <input type="checkbox"/> Board Visible <input type="checkbox"/> Merge Cutouts	Pad Types: <input checked="" type="checkbox"/> Component Pads <input type="checkbox"/> Doc Symbol Pads <input checked="" type="checkbox"/> Bond Pads <input type="checkbox"/> Free Pads <input type="checkbox"/> Mounting Holes <input type="checkbox"/> Comp Mount Holes <input type="checkbox"/> Vias <input type="checkbox"/> Micro-vias	Pad Condition: <input checked="" type="checkbox"/> Surface Mount Through Hole: <input type="checkbox"/> Plated <input type="checkbox"/> Non Plated <input type="checkbox"/> Only If Testpoint <input type="checkbox"/> Exception Only Draw/Plot Appearance <input checked="" type="checkbox"/> Pad Land <input type="checkbox"/> Drill Hole	Areas Visible Component <input checked="" type="checkbox"/> Body <input checked="" type="checkbox"/> Clearance <input checked="" type="checkbox"/> Others <input checked="" type="checkbox"/> Design Board Cutouts <input type="checkbox"/> Unplated <input type="checkbox"/> Plated	Break Shapes <input type="checkbox"/> Break Around Pad <input type="checkbox"/> Break Around Text <input type="checkbox"/> Break Comp Shapes At Board Gap: <input type="text" value="0.0000"/>	Layer Mask Min Mask Width: <input type="text" value="0.0000"/> Min Mask To Track: <input type="text" value="0.0000"/>
				Variant Components <input type="checkbox"/> Items Visible In All Variants <input type="checkbox"/> Use Variant Style	Panel <input type="checkbox"/> Check Items Outside Board <input checked="" type="checkbox"/> Draw Shapes in Panel Design

Generally speaking, solder resist masks require an oversize on the plots to allow for mask shrinkage, movement and inaccuracies in the plot. For this oversize you should consult your board manufacturer but they will require approximately a 5 thou oversize on all the pads. Use the **Oversize When Plotting** entry box to enter a suitable value. You can also grow plots by a percentage value but consult your manufacturer first.

If the Technology file does not contain a Solder Mask layer this can be added using the **Layers** dialog in the **Technology** option. This layer should contain a Layer Class that contains all of the pads and vias.

Once the Solder Mask layers have been created, you use the **CAM Plot** option to output the plot.

The **Auto Generate** option will generate both the Top and Bottom Solder Mask layers automatically if they don't already exist in your Technology file.

Creating Solder paste masks

Solder paste masks are created and used when soldering surface mounted which use a solder paste rather than conventional solder techniques. The solder paste is applied to the board using a screen printing method. Once the surface mounted devices have been placed on the board the board is run through a heat source (a vapour phase or infra-red) and the solder paste melts, attaching the legs of the device to the pad.

For this mask you will require a Pads only plot but of the **Surface Mount** type only.

Name: Paste Mask

Used:

Layer Type: Non-Electrical Essential For Manufacture

Pad Oversize: 0.0000

Absolute Size
 Percent of Pad Size

Min Undersized Pad: 0.0000

Board Visible
 Merge Cutouts

Pad Types:

Component Pads
 Doc Symbol Pads
 Bnd Pads
 Free Pads
 Mounting Holes
 Comp Mount Holes
 Vias
 Micro-vias

Pad Condition:

Surface Mount
Through Hole:
 Plated
 Non Plated
 Only If Testpoint
 Exception Only

Draw/Plot Appearance

Pad Land
 Drill Hole

Area

Cor

Boi

The mask is usually made slightly undersize to allow for the expansion of the paste when heated. The undersize will depend on the manufacturer and the heating method being used, you will need to consult the assembly house before specifying this value. Be aware that there is not always an undersized value used, a normal size plot is often used with a zero pad oversize value.

To create the undersize on the plots, use the **Pad Oversize:** area and choose between **Absolute** and **Percentage of Pad Size** entry boxes. Add the value using a minus number, e.g. -5.0. This will shrink all the pads on the plot by this value. You can also shrink plots by a percentage value but consult your manufacturer first. They prefer a plot of the required pads but with no growth or shrinkage so they can do this themselves to their own specification.

A small word of caution, most manufacturers prefer to receive a Paste Mask of the required layers but using a zero value over/under size. This allows them to adjust the mask layer to their own specifications and tolerances.

If the Technology file does not contain a Solder Paste layer this can be added using the **Layers** dialog in the **Technology** option. This layer should contain a Layer Class that contains Component pads, no vias and includes **surface mount pads**. It can also include **Doc Symbol Pads**, **Free Pads** and **Mounting Holes** if required and if surface mounted.

Once the Solder Paste layers have been created, you use the **CAM Plot** option to output the plot.

Generating Power planes

Full layer power planes that are defined as being internal to the board can be generated using the **CAM Plot** option. You can also generate power planes for any layers, internal and external, with and without embedded items (such as tracks). This is more involved and is discussed later on in this section.

There are also partial power planes that exist on outer layers normally, although they can exist on internal layers as well. These are created using the Copper Pour option and pre-defined Templates. They are output along with electrical layers.

Full power planes can contain one signal for the complete plane or multiple signals on the same plane. To create a split power plane you must use an un-poured Template on the power plane layer. This is discussed later on in this section.

For any layer to become a power plane it must be defined with certain criteria. It must be defined as **Power Plane** layer in the **Technology** file, and if using thermal connections to this plane, must have a **Net** name associated with it.

	Wires Top	Wire Link	Top	None		
Y	Pin Names	Non-Electrical	Top	None		
	Prepreg A	Construction		None		Prepreg (0.11)
	Prepreg B	Construction		None		Prepreg (0.11)
	Inner 2	Electrical	Inner	Y		
	Substrate	Construction		None		FR4 (1.0)
	Ground	Power	Inner	Power Plane	Gnd	Copper 1oz
	Prepreg D	Construction		None		Prepreg (0.11)
	Prepreg C	Construction		None		Prepreg (0.11)
	Power	Power	Inner	Power Plane	VCC	Copper 1oz
	Inner 5	Electrical	Inner	X		

In the example dialog above, the **Ground** and **Power** layers have a **Bias** of **Power** (Power Plane) and **Nets** associated with them, **Gnd** and **VCC** respectively. The **New** or **Edit** options will allow you to create this layer.

Name:

Used:

Class:

Type: Physical Copper Layer

Layer Association:

Can Have Associated Layers

Top Facing Side:

Bottom Facing (Mirror Components)

Allow Normal Components Allow Buried Components

Allow Micro-via Stop Pad Either Side

Electrical Details:

Routing Bias:

Power Plane Net:

Construction Details:

Material:

Thickness:

Embedding:

Usually Plotted

In Layer Stack Preview

From this, any pads which pass through the power plane and which uses the same net name will be connected using a **Thermal** connection or thermal spoke. The connection will be made according to the rules defined in the **Technology** file under **Thermal Rules**.

Attribute:

Match:

Applies To:

Min Pad Size:

On Layers:

Side:

or Layer:

Within Areas:

Connect Type:

Enclosed Pads Only:

Orthogonal Spokes:

Isolation Gap:

Number Of Spokes:

Minimum Spokes:

Try Alternative Rotation:

Rotate With Pad:

First Spoke Angle:

Spoke Style:

Thermal Spokes (15)

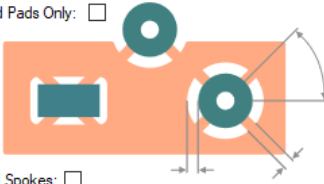
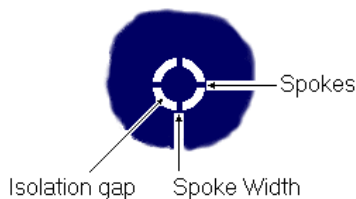
With these items defined, the **CAM Plot** option understands how to process the power plane layer.

Unlike other electrical or non-electrical plots where items rather than planes are being plotted, the plots required for power planes require more interaction.

If you use the **Auto Generate** option to create your basic plot types to start with, power plane plots are automatically created and included if your Technology has power plane layers defined.

If the plane layers are added afterwards in addition to existing layers, you can use the **CAM Plot wizard** in the **CAM Plot** dialog to generate the required plane plots.

The **Process** page of the **CAM Plot wizard** enables you to define the **Name** of the plot. **Output To** will allow you to select the device to output the plot to.

The **Output** page displays information about the style of the plot because the layer is already defined in your Technology, the **Process** box will contain a layer called Ground, this will be shown as **Layer Ground**.

The **Style** of the plot can be **Artwork** (true size of all items in the plot) or **Outline** (a centre line check plot). For power planes, you would normally use Artwork. **Mirror** allows the plot output to be mirrored. You might use this when plotting the bottom side of the design so that the image plotted on film is closer to the board for the photo-resist process.

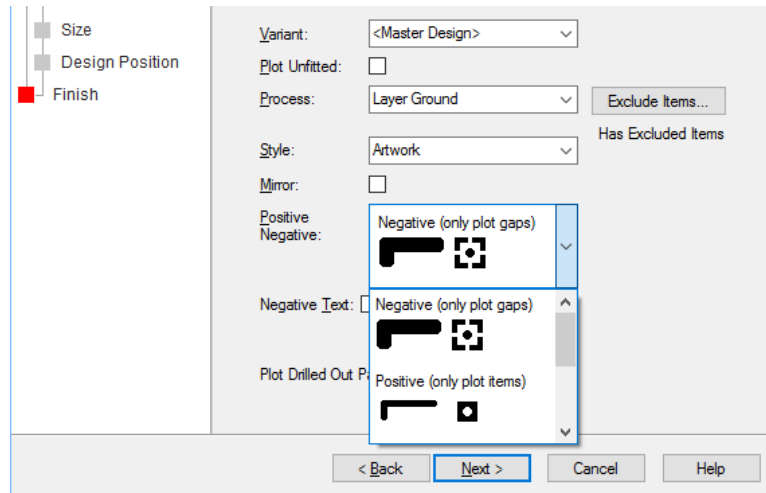

The **Plane Style** is used to define the type of power plane plot required. For most instances where a power plane plot file is supplied for plotting, a Negative plot is generated. This will be a plot of the gaps only but will be reversed by the plot house. The effect of plotting the plane as negative is that the plot is significantly smaller than if a positive plot is output, this can be a factor of 20-30 times smaller in the case of large designs.

Where plots are combined as would be the case in a composite plot of a plane with its embedded tracks, a positive plot would be used as well. This is discussed later on in this section.

The following pages of the wizard setup the scale, position and rotation of the plot. This is the same procedure for all plot types.

Verifying the Power planes

Pulsonix has a feature for viewing the full power plane layers without generating the plot first. This option uses the same CAM Plot mechanism used to generate the actual plot files so you can see the results live before they are created.

► **To view powerplanes in your design**

1. Create a **Powerplane** layer in your **Technology** and assign a **Net Name** to it.
2. You can use the **View Powerplane** option to view planes before they are plotted.
3. To do this, display the **Layers Bar** (from the **View** menu) also **Ctrl-L** by default.

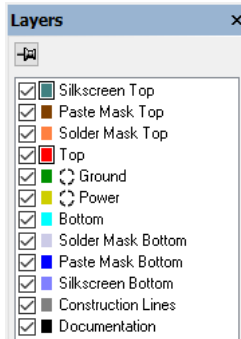

4. For the **Powerplane** layer in the list, **Ground** in this case, there will be a Powerplane indicator next to the layer colour



5. This indicates the thermal relief of a powerplane.
6. Select this symbol. The symbol changes to a negative and the design will now be drawn in powerplane view.



7. Using the **Layers Bar**, you can also make the powerplane stand out more by switching off other layers.
8. Once you have finished viewing your powerplane, switch back to a normal view by selecting the thermal relief symbol again. It will revert back to a positive image.
9. Alternatively, you can find this functionality on the **View** menu under the **View Power Plane>** option. From this, you can **Display** the powerplane, **Regenerate** the powerplane view if items have been edited or moved on the design, and you can **Hide** the plane view to revert back to a normal view.

The full plane is displayed like this:

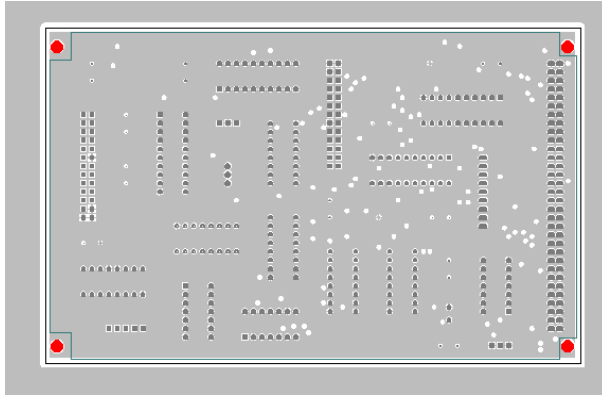

With a small section when zoomed in looking like this, clearly showing the thermal connections and isolation with the plane.



As with all plots though, you should always check that the final plot is what you expect it to be. To do this it is highly recommended that you use a dedicated Gerber viewer utility; these are available from numerous web sites on the internet.

Windows Verification Plots

You can also use the **Produce Windows Verification Plot** option from the **Gerber Setup** dialog on the **Plot Settings** page of the CAM Plot option. This will automatically produce you a Windows print every time a Gerber output is run.

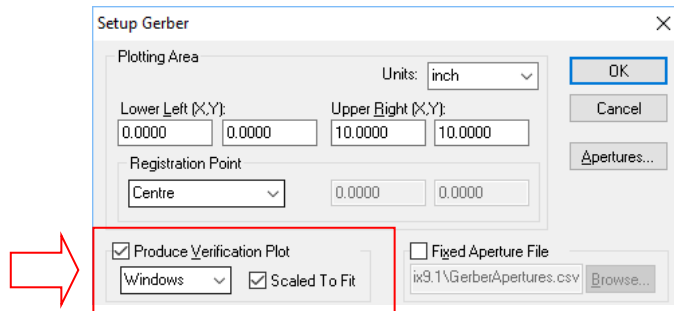

Using the Isolate From Plane option

There are some special cases where you may wish to change the thermal 'connections' to the power plane to be completely isolated or to be a solid connection without thermal relief or isolation gap.

For each pad on the net you can select its **Pad Properties**. From this dialog, using the **Pad** page you can change the property of the **Power Plane Connection**. This is also available when creating the footprint in the Footprint Editor.

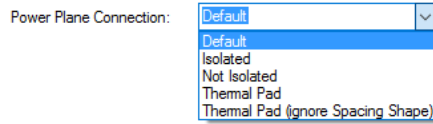

Isolated will give you a complete isolation from the plane (see note below), **Not Isolated** will make a solid connection to the plane, and **Thermal Pad** will give you the ‘normal’ thermally connected and isolated connection.

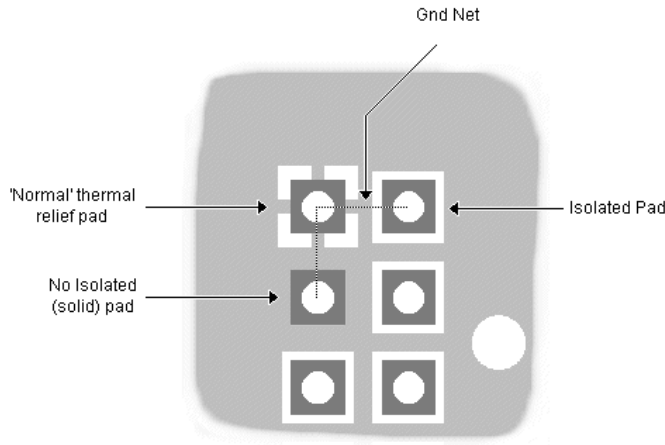

When the **Isolated** option is used, if this pin is not connected to the plane, you can run the Net Completion Report from the Report option to identify any splits.

Composite Power planes

Where power planes contain additional items such as tracks, the generation of the plane can be done in two way; single combined plot or a two-plot composite created in two-stages. The single composite plot created in Pulsonix may not be suitable for some manufacturing processes, hence the two-stage process plot output would then be required. Both methods are detailed below.

Single composite plot

A single plot is created using the **Plot Wizard** in Pulsonix. On the **Output** page, the **Positive/Negative:** drop down list will reveal a **Positive (plane & items)** option.

By selecting this you will effectively be able to allow Pulsonix to create a combined plot of both positive and negative plane views as a composite (as you would if you used the second method below).

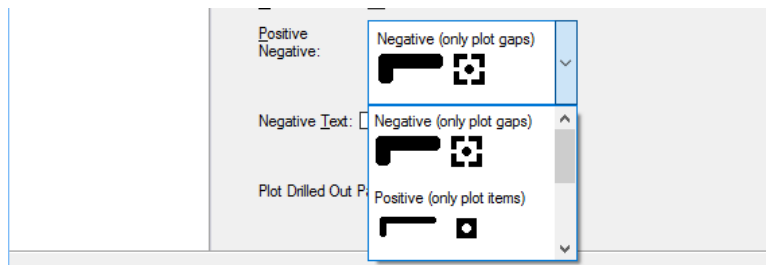

Composite plots

There are two methods for generating composite plots; a power plane plot with both plane and embedded tracks with isolation around them.

Method One – One single plot combining all information as a finished composite

Instead of creating two plots (which can still be done if your processing requires this), you will create one plot which already includes the embedded tracks and allows isolation around these tracks to clear them from the powerplane plot.

To do this, create a plot using the power (or ground) layer and in the **Output** page of the **Cam Plot Wizard**, select **Positive (plane & items)** in the **Positive/Negative:** entry.

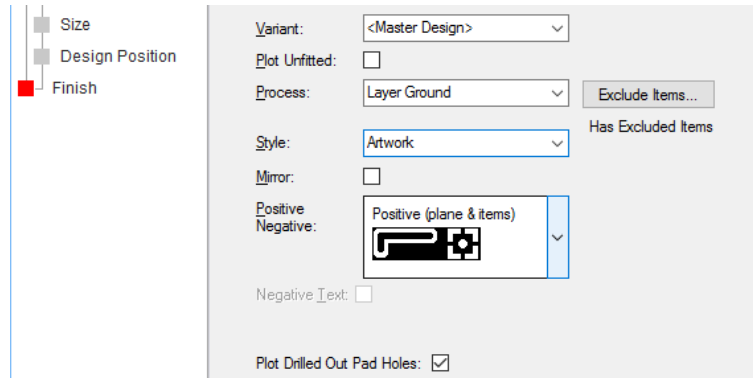

Once this layer is included in the **CAM Plot** dialog, this will be all you need to do to create the composite plot.

Method Two – Two separate plots, composite as a separate process.

You first must generate a negative plane that contains thermal connections but must also contain the gaps required for the tracks to exist. The gap is the thickness of the track plus the spacing clearance around it. This negative plot will be reversed by the plot-house.

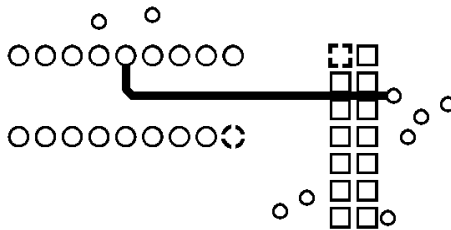

Reversed, the plot will appear like this:

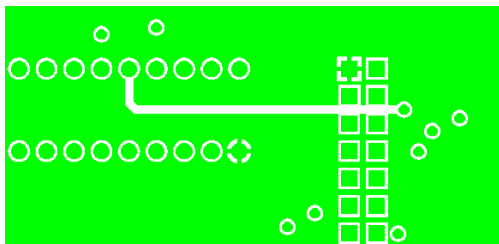

Secondly, you must create a plot of the tracks on this layer, this will be a positive plot of the items only. Use the **CAM Plot** option and the **CAM Plot** wizard to create this plot using the same plane layer as for the plane plot.

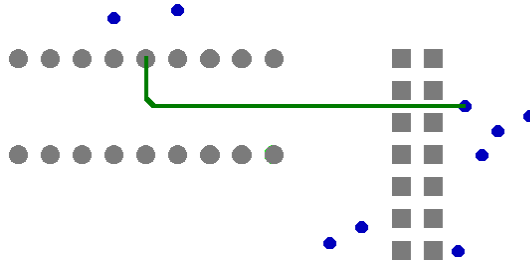

The tracks plot is combined with the reversed plane plot to give you a final composite plot that looks like this (and as viewed in Pulsonix using the **Power Plane Display** option):

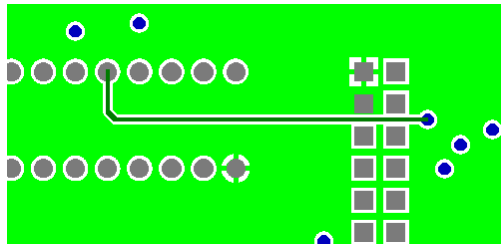

This technique can be used for outer layers where copper plane coverage with or without net association is required. This would be full coverage of the layer rather than partial coverage using Copper Pour. The only change to the process described above would be the layer definition in your Technology. The **Bias** would be changed from **Electrical** to **Power Plane**.

You will also need to create the two plot types, one using a negative plot (for the plane) and the other using a positive plot (for the tracks). These would be created in the **CAM Plot** option using the **CAM Plot** wizard.

Creating Split power planes

Creating split power planes on the inner layers can be done using any number of splits. This situation can be easily achieved in Pulsonix using a combination of a power plane layer and Template area shapes.

Split power planes are generally used where two or more different nets are required as a single power plane on an inner layer but where they are not connected, typically these might be analogue and digital grounds. The components in the design would be placed where neither signals connected to these devices would exist in the opposite plane area.

There are two methods to achieve this effect depending on the final manufactured requirement.

When using split power planes, the 'trigger' for creating a split plane is the **Layer** definition in your **Technology**. The **Layer** must be **Bias** using a **Powerplane** type. The **Net Name** association is optional but if used, can be the 'default' net name for this layer.

The **Technology** dialog below shows the layer Inner and its associated **Net Name Gnd**.

	Name	Associated Layer	Class	Side	Bias	Net	M
		Board	Board Outline	Top	None		
		Wires Top	Wire Link	Top	None		
Y		Silk Top	Silkscreen	Top	None		
Y	Top		Electrical	Top	X		
Y	Ground		Electrical	Inner	Power Plane	GND	
Y	Inner2		Electrical	Inner	X		
Y	inner3		Electrical	Inner	Y		
Y	inner4		Electrical	Inner	X		
Y	inner5		Electrical	Inner	Y		
Y	Power		Electrical	Inner	Power Plane	VCC	
Y	Bottom		Electrical	Bottom	Y		
		Silk Bottom	Silkscreen	Bottom	None		
		Wires Bottom	Wire Link	Bottom	None		
Y	Documentation		Documentation		None		

The Template will appear on the Ground layer and will be named using the Net name required to be connected to the split plane, in this example ANALOGUE_GND.

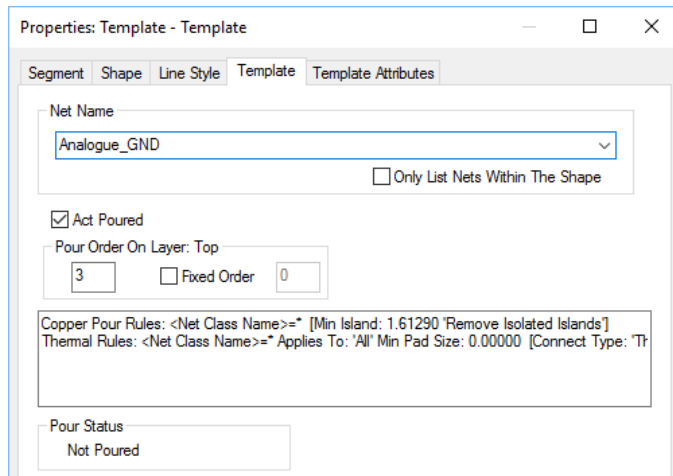

By adding any Template area to this power plane layer, providing it has a Net name, any components within the area using the same net name will now be connected automatically during the CAM/Plot output. The remainder of the area, effectively with the power plane net name, will be processed as a power plane as normal. For this to work successfully, the Template area must not be poured. All you are doing at this stage is defining a named area that the CAM/Plot out can use and connect the relevant devices into. By using a combination of the power plane and the named Template you can create the two areas on the same power plane layer.

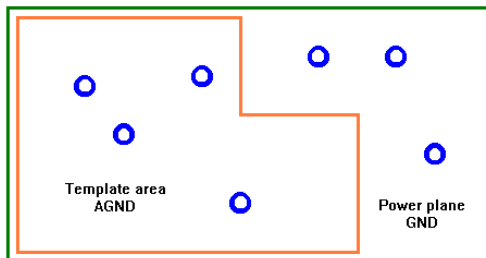

If you attempt to pour a Template that exists on a power plane layer a warning message will be displayed. If you ignore this warning and pour the Template, when you process the power plane layer through the CAM/Plot option, the plot will not be correct.

The second method is where you wish to have the power plane layer with its nominated Net name but use Templates to define all of the areas of the power plane layer. By using a Template of the same Net name used for the power plane layer association, the power plane is effectively ignored.

The Template areas are still processed as a split power plane layer but any area outside these Templates is ignored and in the final plot will be void of copper even if the plane layer net name is the same as one used in the Templates.

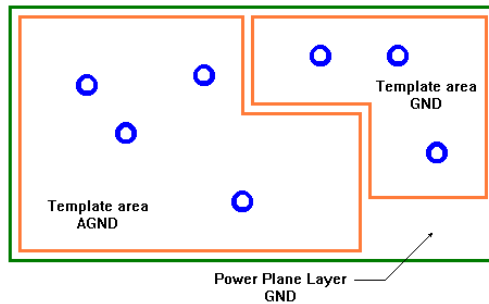

Design rules checking split planes

When defining the Template areas, the line style used for the outline will provide the ‘gap’ when plotted thus separating the two planes.

Additional checks are performed by both the **On-line DRC** and the **Batch DRC** options.

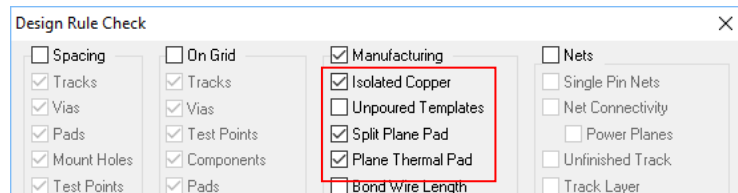

This option checks for pads within split planes that are on the same net as the split plane, but cross the split plane outline. These pads must be completely inside or outside of the plane outline. If they are on the outline they may not end up being attached to the plane when plotted.

There is also an additional check made so that pads that should be included inside a Template are actually within the outline and not isolated.

Breaking Silkscreen

Break Silkscreen is used to break the Silkscreen over holes and vias to stop the silkscreen paint going down the hole. This is available on the **Layer Class** dialog as layer type specific options – **Break Around Pad** and **Break Around Text**. The **Gap** between the item and silkscreen can also be defined using the current design units.

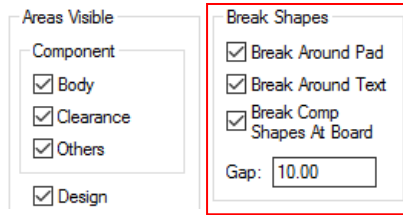

The picture below shows the effect of break silkscreen when the plot is viewed or created:



Creating an output for NC Drilling machines

Pulsonix can generate NC Drill format files using the ‘Excellon’ format. The format can be changed using the **CAM Plot Setup** option and the **Excellon** device. Excellon is more of a generic format and as such can be used to drive the Chinonberg or the Ceib & Myer drilling machines with small format changes.

To enable the drill drawing option to be used, you must create a set of layers and spans in the **Technology** dialog that will be used for plotting.

	Name	From Layer	To Layer	Type
Y	<Through Hole>	<Top Side>	<Bottom Side>	Through Hole
	Top - Inner2	<Top Side>	Inner 2	Blind from Top
	Inner5 - Bottom	Inner 5	<Bottom Side>	Blind from Bottom

As with all plot types, the layers used in the Technology form the basis of the plots required. This includes the Layer spans used for NC drilling and drill drawings.

From the **CAM Plot wizard**, the **Process** page is used to **Name** the plot and specify the output device. If you choose **Excellon**, for the NC Drilling machine type, a drilling output will be created, this is reflected in the **Style of Drill** on the **Output** page.

The CAM Plot option will understand the differences in electrical layers and layers defined for drilling or drill drawing information.

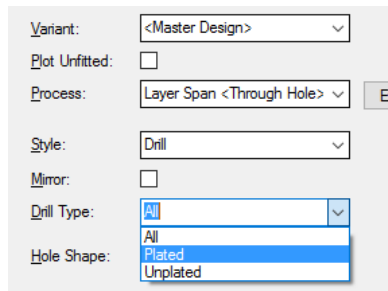

The **Process** entry will allow you to select the layer spans created in the CAM Plot dialog. If blind and buried vias have been defined in your Technology, these will be available in the drop down list.

The **Drill Type** allows you to select **All** drill holes, **Plated** or **Unplated** holes. The plate status of a hole is defined for each drill when creating the **Pad** definition in your **Technology**. This selection

allows you to create a combined plot of all drill holes or to create separate plots of plated and unplated drill holes.

The **Hole Shape** entry enables you to select specific plots based on whether a hole is **round** or **non-round**, for example a **slotted hole**.

The screenshot shows a dialog box with the following fields:

- Variant: <Master Design>
- Plot Unfitted:
- Process: Layer Span <Through Hole> Ex
- Style: Drill
- Mirror:
- Drill Type: All
- Hole Shape: All (dropdown menu is open showing options: All, Non Round, Round)

As with other plots, the **Mirror** switch can be used to mirror the output plot. For NC Drill outputs this is left unselected.

The remainder of the CAM Plot wizard defined the **Scale**, **Rotation** and **Position** of the plot as normal. The report contains information about the drill file produced. This report should be sent along with the NC Drill file to the people manufacturing your PCB.

Outputting Drill drawings

Drill drawings are used during manufacturing to help identify changes in drill tools where different drill sizes are used. A plot of drill holes/symbols, drill letters and a chart of associated sizes can be generated by Pulsonix with control over the drill symbols used and the letter association.

To enable the drill drawing option to be used, you must create a set of layers and spans in the **Technology** dialog that will be used for plotting.

	Name	From Layer	To Layer	Type
Y	<Through Hole>	<Top Side>	<Bottom Side>	Through Hole
	Top - Inner2	<Top Side>	Inner 2	Blind from Top
	Inner5 - Bottom	Inner 5	<Bottom Side>	Blind from Bottom

As with all plot types, the Layers and Layer Classes used in the Technology form the basis of the plots required. This includes the Layer spans used for NC drilling and drill drawings.

There are two methods of exporting drill drawings; 1. Using the method below for exporting specific drill drawing information from the CAM/Plot dialog, or 2. Create a Drill Drawing layer (which can be viewed in the design) and plot this as you would any other plot, using Gerber, PDF etc.

The CAM Plot Drill Drawing Output Method

From the **CAM Plot wizard**, the Process page is used to **Name** the plot and select the output device. The Name should be something representative of the final plot type. If you choose **Excellon**, for the NC Drilling machine type, a drilling output will be created. If another plot device is selected using **Output To** (for example, Windows), the CAM Plot option will know that the drilling information is being used for a drill drawing. It will automatically change the plot **Style** to Drill Drawing on the **Output** page.

The **Output** will be a Layer or Span selection taken from the **Technology** and **Layers** definition. If blind and buried vias have been defined in your Technology, these will be available in the drop down list.

Variant:	<Master Design>	▼
Plot Unfitted:	<input type="checkbox"/>	
Process:	Layer Span <Through Hole>	▼ Ex
Style:	Drill Drawing	▼ Has
Mirror:	<input type="checkbox"/>	
Drill Type:	Plated	▼
Hole Shape:	All	▼

The CAM Plot option will understand the differences in electrical layers and layers defined for drilling or drill drawing information.

As with other plots, the **Mirror** switch can be used to mirror the output plot. For drill drawings this is usually left unselected.

The **Drill Type** allows you to select **All** drill holes, **Plated** or **Unplated** holes. The plate status of a hole is defined for each drill when creating the **Pad** definition in your **Technology**. This selection allows you to create a combined plot of all drill holes or to create separate plots of plated and unplated drill holes.

As with normal NC Drill outputs, the **Hole Shape** entry enables you to select specific plots based on whether a hole is **round** or **non-round**, for example a **slotted hole**.

The remainder of the CAM Plot wizard defined the Scale, Rotation and Position of the plot as normal.

When the plot is produced it will look something like this:

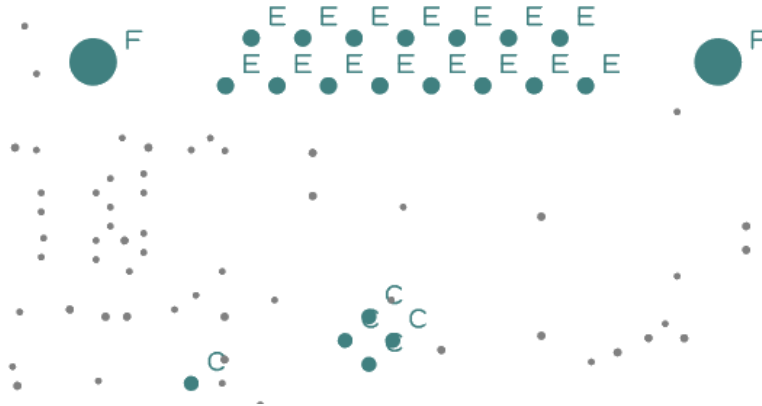

To make a plot clearer, generally the most used drills are not indicated. A representative drill hole marker symbol is shown however to indicate a drill position. A drill table or drill report will be used in conjunction with the drill drawing plot to associate the drill letter with the actual drill sized used. The drill drawing layer can also be viewed in the design and will replicate the settings from the Drill sizes dialog.

Changing the drill letters and symbols

From the **Plot Settings** dialog in the **CAM Plot** option, the **Drill Sizes** button will open the following dialog:

Generate Plot - Drill Sizes

CAM Plots Plot Settings Drill Sizes Plot Preview

Used	Diameter	Plated	Id	Symbol	Symbol Size	Symbol Filled	Count	Min Diam	Max Diam	Description
	0.200	Y	H	Round	0.200	<input checked="" type="checkbox"/>	0			
Y	0.254	Y	G	Round	0.254	<input checked="" type="checkbox"/>	6			
	0.610	Y	A	Round	0.610	<input checked="" type="checkbox"/>	0			
	0.762	Y	E	Round	0.762	<input checked="" type="checkbox"/>	0			
Y	0.889	Y	B	Round	0.889	<input checked="" type="checkbox"/>	83	0.813	0.889	
Y	1.067	Y	C	Round	1.067	<input checked="" type="checkbox"/>	9			
	1.143	Y	I	Round	1.143	<input checked="" type="checkbox"/>	0			
	1.270	Y	D	Round	1.270	<input checked="" type="checkbox"/>	0			
Y	2.000	Y	F	Round	2.000	<input checked="" type="checkbox"/>	5			
	2.540	Y	J	Round	2.540	<input checked="" type="checkbox"/>	0			

Drill Sizes:
Tolerance: 0.000 Step: 0.100 Define Allowed Sizes 4 Allowed Sizes

Drill Id
Text Style: TextStyle35.0-3.0

Offset
X 0.00000 Y 0.00000
 Relative to right edge of symbol

Length Units
 Imperial: thou
 Metric: mm
Name: mm
Precision: 3
 Trailing Zeros Rounding Indicator (+/-)

Reset
Rename All
Report...

From this you can define the drill diameter association with the Drill ID and Drill Symbol to be used on the drill drawing plot.

The setup of this dialog has been discussed previously in this Chapter, please refer to this for a more detailed description.

Automatically adding a drill table to the design

You can automatically add a drill table of the drills used in the current design to the design.

For this, Pulsonix has the **Insert Drill Table** command. This can be run using the **Insert Drill Table** option on the **Insert** menu.

When the Insert Drill Table command is run a dialog is displayed from which to select the **Layer Span** of the drills (you can choose any spans including those used for blind and buried vias). The **Show Table** on enables you to select the layer to add the table to.

Insert Drill Table

Drills For Layer Span: <Through Hole> OK

Show Table On Layer: Documentation Cancel

Include Symbol

When added, the drill table will look like this:

Diam (thou)	Qty	Id	Plated	Symbol
15.0	310	A	x	●
32.0	23	B	x	■
42.0	6	C	x	▲
100.0	2	D	x	✳

The table can be moved in the design by dragging it or by using the Move command.

The table is updated when the **Update Drill Table** command is run from the context menu (after selecting the table), and each time the **Print** or **CAM Plot Run** options are used or when the design is saved.

Coloured Drill Sizes & Drill Table

You can add a **Colour** to a **Drill Size**. When used, the drill ID and symbol are drawn in that colour. Add the colour using the **CAM Plots** dialog and **Drill Sizes** or define it in the **Technology** file. Select the **Colour** from the drop down list. Selecting **Use Own Colour** will force that colour to be used. If not selected, it will use the default colour.

Used	Diameter	Plated	Id	Symbol	Symbol Size	Symbol Filled	Count	Min Diam	Max Diam	Description	Use Own Colour	Colour
Y	9.8	Y	A	Round	9.8	<input checked="" type="checkbox"/>	28				<input checked="" type="checkbox"/>	Red
	20.1	Y	B	Round	20.1	<input checked="" type="checkbox"/>	0				<input checked="" type="checkbox"/>	Grey
	35.0	Y	C	Round	35.0	<input checked="" type="checkbox"/>	0				<input checked="" type="checkbox"/>	Blue
	98.4	Y	D	Round	98.4	<input checked="" type="checkbox"/>	0				<input checked="" type="checkbox"/>	Green

The drill ID and symbol in the **drill table** are drawn in that colour.

Diam (thou)	Qty	Id	Plated	Symbol
16.0	151	A	Y	●
33.5	52	B	Y	●
37.4	52	C	Y	●
39.4	4	D	Y	●
93.7	2	I	Y	●
126.0	4	J	Y	●
Special	3	K	Y	●

Viewing Drill Drawings in the Design

You can display a drill drawing layer which will display the drill symbol and drill id in the design. These layers can be plotted instead of the existing drill drawing output.

Diam (thou)	Qty	Id	Plated	Symbol
30.0	1	E	Y	*
35.0	49		Y	●
42.0	9	C	Y	▲
78.7	4	F	Y	●

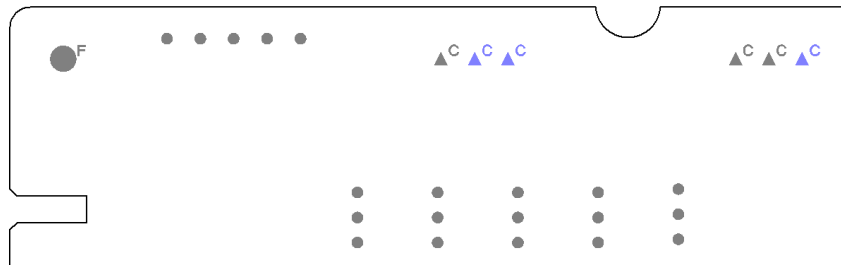

You can also add other items such as the drill ident table to this layer.

The Drill Drawing layer is defined as a type of layer class, then used with a new Drill Drawing layer.

The **Layer Type** to use is called **Drill Drawing**. This is used to create the layer class used for a Drill Drawing layer in the **Layers** page.

Name:

Used:

Layer Type:

Pad Oversize: <input type="text" value="0.000"/> <input checked="" type="radio"/> Absolute Size <input type="radio"/> Percent of Pad Size Min Undersized Pad: <input type="text" value="0.000"/>	Pad Types: <input checked="" type="checkbox"/> Component Pads <input checked="" type="checkbox"/> Doc Symbol Pads <input type="checkbox"/> Bgnd Pads <input checked="" type="checkbox"/> Free Pads <input checked="" type="checkbox"/> Mounting Holes <input checked="" type="checkbox"/> Comp Mount Holes <input checked="" type="checkbox"/> Vias <input checked="" type="checkbox"/> Micro-vias	Pad Condition: <input type="checkbox"/> Surface Mount Through Hole: <input checked="" type="checkbox"/> Plated <input checked="" type="checkbox"/> Non Plated <input type="checkbox"/> Only If Testpoint <input type="checkbox"/> Exception Only <input checked="" type="checkbox"/> Board Visible <input type="checkbox"/> Merge Cutouts	Areas Visible Component <input type="checkbox"/> Body <input type="checkbox"/> Clearance <input type="checkbox"/> Others Design <input type="checkbox"/> Unplated <input type="checkbox"/> Plated	Break Shapes <input type="checkbox"/> Break Around Pad <input type="checkbox"/> Break Around Text <input type="checkbox"/> Break Comp Shapes At Board Gap: <input type="text" value="0.000"/> Draw/Plot Appearance <input checked="" type="checkbox"/> Pad_Land <input type="checkbox"/> Drill Hole	Variant Components <input type="checkbox"/> Items Visible In All Variants <input type="checkbox"/> Use Variant Style Panel <input type="checkbox"/> Check Items Outside Board <input checked="" type="checkbox"/> Draw Shapes in Panel Design
---	---	---	---	--	--

When using the Drill Drawing Layer Class, many items are preselected for use. You can also add other useful items to document your drill drawing, such as the **Board Outline** or **Areas**.

The Layer itself is relatively straight forward. You should define a **Name** for the layer and use the **Drill Drawing layer class**. The **Type** will inform you that it is a **Layer Type** of **Drill Drawing**.

You can create more than one Drill Drawing layer, for example, if you wish to have a drill drawing per layer span for your design showing layer spans other than <Through Hole>. To do this, create a new layer with a new name, use the Drill Drawing layer class and then choose the layer span that it will be **Associated With** using the drop down list of layer spans.

The **Drill Holes** check boxes allow you to select the type of drill hole you wish to view on the drill drawing.

board	board	none				
Construction Lines	Documentation	None				
Documentation	Documentation	None				
Drill Ident	Drill Ident	None				Board Thic 1.630

Name: Drill Ident

Used:

Class: Drill Ident

Type: Drill Drawing

Layer Association:

Associated With: <Through Hole>

Drill Holes:

Plated Round

Non Plated Non Round

Electrical Details:

Routing Bias: None

Power Plane Net:

Construction Details:

Material:

Thickness: 0.000 New Material...

Embedding: None

Usually Plotted

In Layer Stack Preview

You will only see the full effect of this layer if you switch the drill drawing layer on by itself. If you don't, drill letters can be drawn underneath other items such as copper pads and will be obscured.

Combining plots

When generating output plots of your design, you may require information from one or more plots to be combined. For example, a Silkscreen plot and a Documentation plot, which combined will give you enough information to view Component positions and show the dimensioning of these positions. Another example could be where you have a separate board outline layer, this can be combined with any other layer which might not have the board outline shown on it in its layer class definition.

Typically, where Layer Classes have been specifically defined to cater for special cases of layers, such as a Board Outline or Solder Paste Mask, there is more of a requirement to combine plots.

The plot combining is a process of the **CAM Plot** output option although it uses the **Layer** definitions and **Layer Classes** defined in your **Technology**.

From within the **CAM Plots** option you can use the **Add To Plot** button once an existing plot has been selected. Plots can be added to existing plots, or you can create a new plot to define the combined plot.

The **Add To Plot Wizard** is a basic plot wizard but adds the plot defined to the plot selected.

The **Process** page will confirm the name of the existing plot selected.

CAM Plot Wizard - Editing Plot 'Top Electrical' - Subsidiary Plot

Start

Process

Output

Offset

Finish

Choose a name for this plot and choose the type of output

Define the name which will be used to identify this plot in dialogs and reports. Also choose the type of output.

Name: Top Electrical

Plot Group:

Output To: Windows

Printer Name: <Default Printer>

The **Output** page will require that you select the name of the layer to add. The drop down list will provide you with a selection of all the layers in the design.

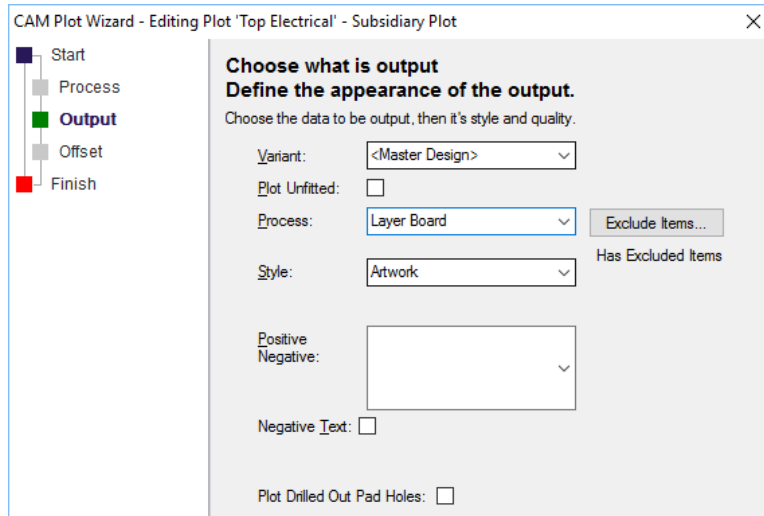

The **Offset** page will allow you to align the plot with the main plot and it will also allow you to create an offset plot. This means you could plot a set of plots by using an offset to plot say 4 layers on each quadrant of one page.

When the **Finish** button is selected the plot is added to the existing plot.

Once back in the **CAM Plot** dialog, the added plots will appear by name in the **Process** column. You can add more than one plot process to any existing plot, these will be shown in order as they are added.

Name	Enabled	Device	Process	Variant	Scale	Rotat
Top Electrical	<input checked="" type="checkbox"/>	PDF		<Master Design>	1.000	Auto
			Layer Silkscreen Top	<Master Design>		
			Layer Documentation	<Master Design>		
			Layer Construction	<Master Design>		
			Layer Board	<Master Design>		
Bottom Electrical	<input type="checkbox"/>	Gerber		<Master Design>	1.000	Auto F
Top Silk Screen	<input type="checkbox"/>	Gerber	Layer Silkscreen Top	<Master Design>	1.000	Auto F

Plot Transformations and Positioning in Plot Preview

The **Plot Preview** page can define multiple layers using the **Add To Plot** option, they can be individually transformed in the **Preview** window. This allows you to add multiple plots of different types and layers to the same target plot.

Where multiple plots have been defined using the **Add To Plot** option, the currently selected plot will be highlighted in orange. The original plot that the others are based off will be shown in black.

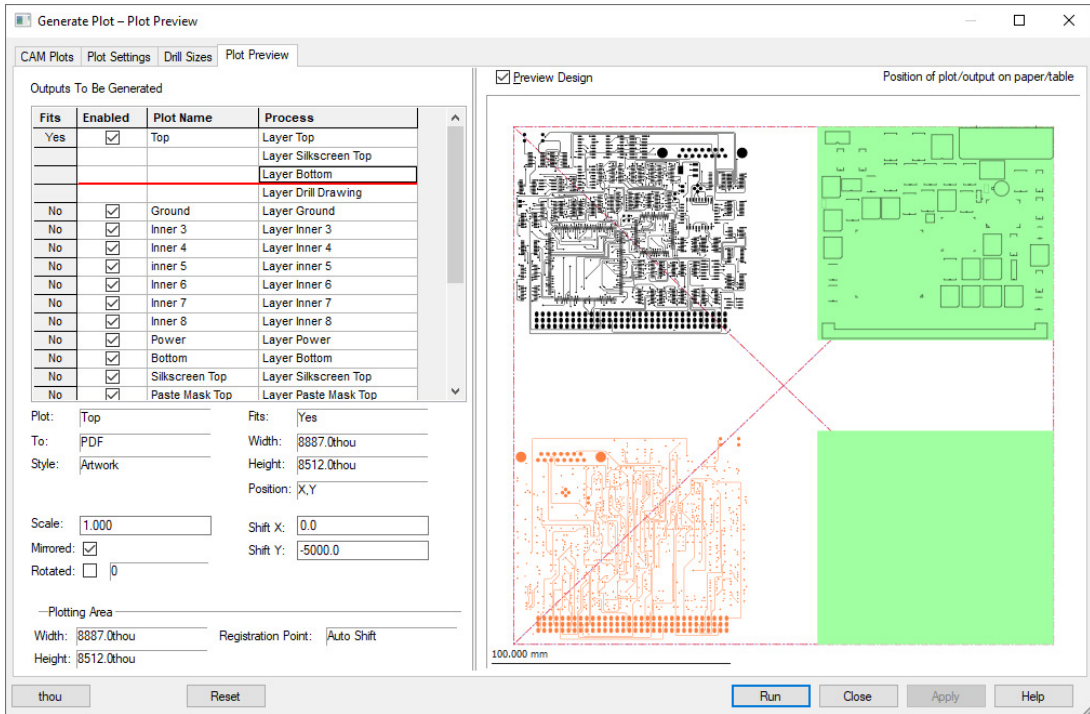

Any transformation performed is given relative to the **Plotting Area Registration Point**.

The transformation is given relative to the **Plotting Area Registration Point** (hence the Shift X & Y will be different values to those specified on the **CAM Plots** page, which give the registration point relative to the design origin.)

The **Reset** button at the bottom of this dialog is used to cancel any pending edits.

Fields can be edited to transform the position of individual plots (where more than one has been defined using the **Add To Plot** option). You can edit the **Scale**, **Mirrored**, **Rotated**, **Shift X** & **Shift Y** values on this dialog. Equivalent values will be set on the original plot where multiple plots are defined.

Plot:	<input type="text" value="Top"/>	Fits:	<input type="text" value="Yes"/>
To:	<input type="text" value="PDF"/>	Width:	<input type="text" value="8887.0thou"/>
Style:	<input type="text" value="Artwork"/>	Height:	<input type="text" value="8512.0thou"/>
		Position:	<input type="text" value="X,Y"/>
Scale:	<input type="text" value="1.000"/>	Shift X:	<input type="text" value="0.0"/>
Mirrored:	<input checked="" type="checkbox"/>	Shift Y:	<input type="text" value="-5000.0"/>
Rotated:	<input type="checkbox"/> <input type="text" value="0"/>		
- Plotting Area			
Width:	<input type="text" value="8887.0thou"/>	Registration Point:	<input type="text" value="Auto Shift"/>
Height:	<input type="text" value="8512.0thou"/>		

The **Shift X** & **Shift Y** values can be defined positively or negatively, depending on how you require the plot to be shifted on the bed relative to the original plot.

Check Plots

Check plots are used when you require ‘quick’ plots of the design but not the full detail, and usually an outline plot of the design items for checking.

The option to set to produce an artwork plot or an outline plot can be found on the **CAM Plot wizard**.

On the **Output** page of the CAM Plot Wizard you can select the **Style** of the plot to be **Artwork** or **Outline**. Artwork would be used for final manufacturing plots and Outline is normally used where a centre line plot is required for checking purposes. This would be used for item positioning checks, connectivity of tracks checks etc. One advantage of this type of plot is its clarity, being on an outline plot, and the speed at which the plot is produced, especially when using a pen plotter.

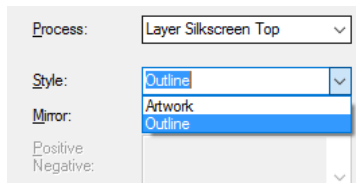

This plot style can be used for Windows printers and pen plotters, as well as the Gerber output plots if required, although this is not common practice.

Using Fiducial Marks

Fiducial marks are registration markers used on a PCB for alignment purposes when using assembly machines. There are normally 3 ‘marks’ (created in either copper or as pads/components) on the board placed outside the board outline. You can also have fiducial marks inserted inside the board outline in localised areas which are used for specific components. Usually large components such as microprocessors, or components that has special placement or alignment requirements have these marks. Smaller components don’t require this extra accuracy and so don’t use their own Fiducial marks.

The types of machines that require these marks are assembly machines and surface mount ‘pick & place machines.

The marks are usually added outside the board as small round pads of about 75-100 thou diameter. These dimensions would need to be confirmed with your board assembly house if using Fiducial marks as they may have specific sizes to use.

You can use either free pads, or create a special single pad Component, or use a single pad Documentation Symbol. The free pad and Doc Symbol will not appear on any Parts list but it also means that you cannot extract the pad positions for inclusion in a report as well.

You can also use Copper shapes as registration marks but again, their positions cannot be extracted into a report.

If you choose to use a Component, any Component name or Silkscreen information should be kept well away from the pad so that the machine can easily recognise the marks.

Whichever method you choose to create these markers, you must ensure that they are added to the Top and/or Bottom copper layers. This is essential, so that when output, the markers appear as a copper item and on the same layer as the Component pads. If they were added as a Silkscreen item, for example, the Silkscreen could slip slightly during its process and the markers would then not be in their true registration location.

The markers should be placed outside the board but their exact location should be confirmed with the board manufacturer or assembly house. Their location will depend on the panel size, the number of

boards on the panel and the alignment tolerances of the machine. An approximate location is shown in the example below:

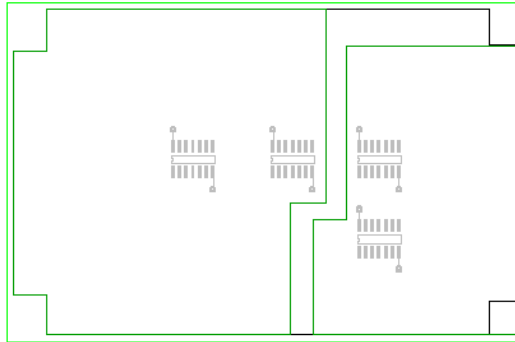

When the assembly house comes to place the components they will either use a report of the Fiducial marks which you have produced, or they will use an optical alignment tool on their assembly machine. The same will apply to the actual Component placement as well. Pulsonix can generate Parts lists in various formats that can be extracted in ASCII using the **Report Maker** option. Most modern machines can accept a Parts list in some sort of format so check what is required by the assembly house. A ‘ready-made’ Parts list will also drastically reduce the possibility of errors.

To produce a report or Parts list of the components and fiducial markers, use the **Report Maker** option located on the **Output** menu. Refer to the *chapter* on producing Reports for more information.

Outputting other formats using the CAM Plot dialog

As well as regular plots such as Gerber, PDF, Excellon etc. you can also export other formats that create a full set of manufacturing data. Quite often you will require the Gerber and Excellon files to produce a board, but you may also require additional files to complement them, files such as ODB++, IPC-2581, LPKF, IPC-356 or STEP/DXF/IDF or GenCAD.

Generate Plot – CAM Plots					
CAM Plots Plot Settings Drill Sizes Plot Preview					
Name	Enabled	Device	Process	Scale	
Top PDF	<input checked="" type="checkbox"/>	PDF	Layer Top	1,000	Au
			Layer Silkscreen		
Top Copper	<input checked="" type="checkbox"/>	Gerber	Layer Top	1,000	Au
Top Silkscreen	<input checked="" type="checkbox"/>	Gerber	Layer Silkscreen	1,000	Au
IPC2581	<input checked="" type="checkbox"/>	IPC-2581		1,000	Au
IPC356 Testpoint	<input checked="" type="checkbox"/>	Format File		1,000	No

These would be added to the plot list using the **New** button and **Plot Wizard** as discussed previously.

Additional Manufacturing Exports using the Output menu

ODB++ format

ODB++ is an intelligent CAD/CAM data exchange format which helps overcome the inherent ambiguity of the Gerber and Excellon formats. This is used by the manufactures as an alternative

format. In fact, some PCB manufacturers are offering more attractive PCB fabrication prices if the PCB design data is delivered in ODB++ format.

The ODB++ export option is located on the **Output** menu. It offers **Compressed** and non-compressed (Folder) versions. Make your choice using the **Compressed** check box.

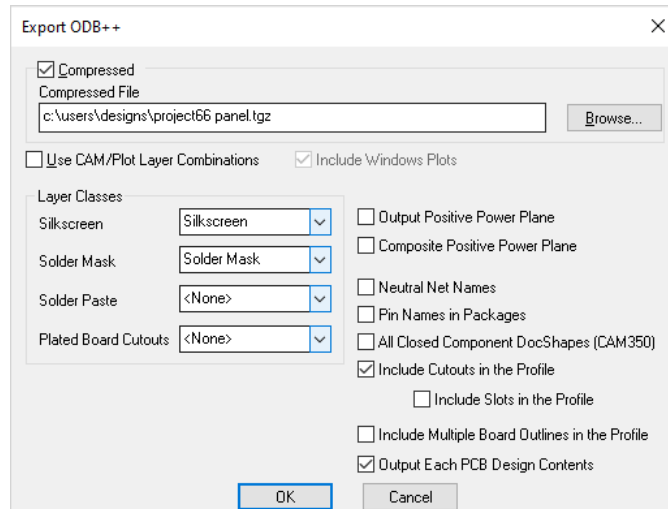

If **Compressed** is selected, it uses the TAR format and produces a single compressed file with the file extension .tgz. It is this file that you send to your manufacturer for processing.

Un-compressed uses a **Folder** structure based on the **Browse** path setting. When used you must send the whole folder structure to the people plotting the design.

The **Use CAM/Plot Layer Combinations** check box allows an alternative output, so that instead of outputting data for every layer in the design, it will output data for each **Gerber** and **Excellon** type plot defined in the **CAM Plot** page of the **Technology** dialog, this includes multiple combine layers. Windows plots will be included if **Include Windows Plots** is checked.

In the ODB++ format, the **Silkscreen**, **Solder Mask** and **Solder Paste** layers need to be identified. Use the appropriate drop down list to select the layer class which will identify these layers. You can select **(None)** if you are not interested in the layer type.

The **Output and Composite Positive Power Plane** options are used when your design contains tracks buried on inner plane layers.

Outputting to Mechanical CAD Systems

As a brief note here, you can also export Pulsonix designs suitable for import into mechanical CAD systems. Pulsonix supports the export of the **STEP** format, **DXF** and **IDF**.

The **DXF** and **IDF** export options are available on the **Output** menu and can be selected for output on the CAM Plot dialog as one of your 'plots'. For further information of these format exports, please refer to the **Online Help** within the Pulsonix program.

STEP Export

The **3D Design** menu enables you to define, Preview and export STEP files.

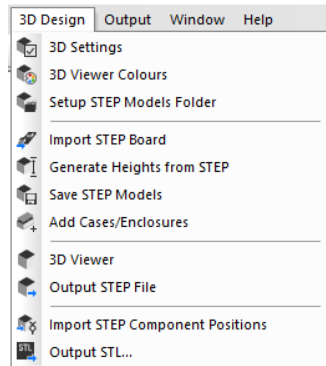

Outputting for Documentation

You can set up a CAM Plot to produce an SVG 'plot' for use within your documentation. The SVG output is available on the list of 'devices' on the drop-down list:

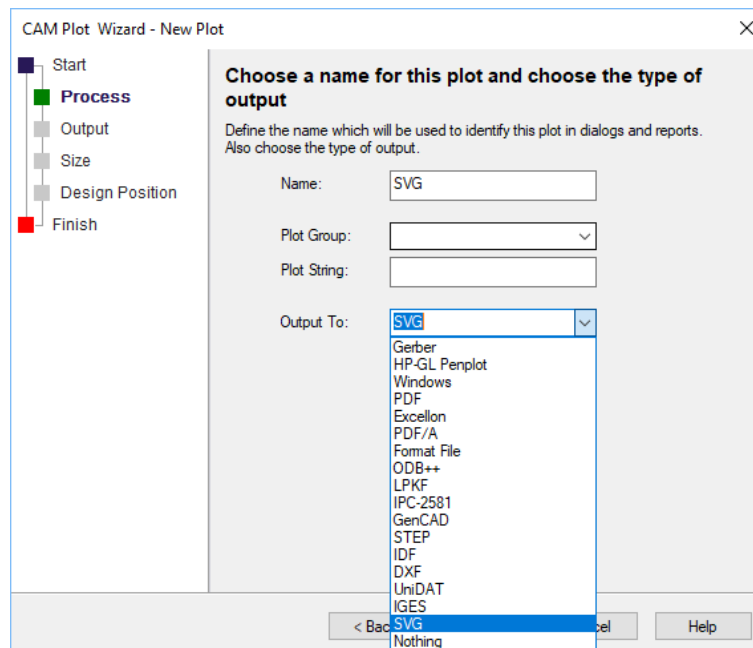

This appears in the CAM Plot list as its own format. Layer processing and combination is as per a regular plot.

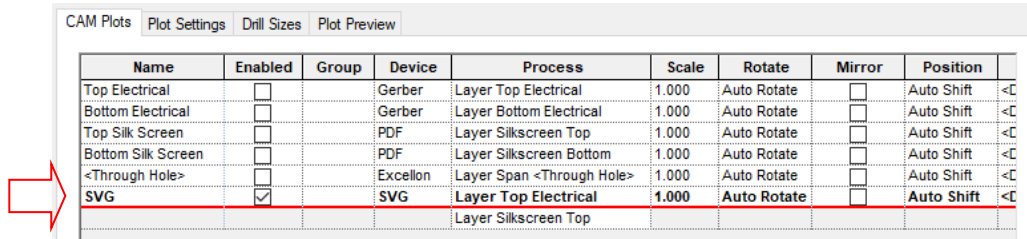

Name	Enabled	Group	Device	Process	Scale	Rotate	Mirror	Position
Top Electrical	<input type="checkbox"/>		Gerber	Layer Top Electrical	1.000	Auto Rotate	<input type="checkbox"/>	Auto Shift <C
Bottom Electrical	<input type="checkbox"/>		Gerber	Layer Bottom Electrical	1.000	Auto Rotate	<input type="checkbox"/>	Auto Shift <C
Top Silk Screen	<input type="checkbox"/>		PDF	Layer Silkscreen Top	1.000	Auto Rotate	<input type="checkbox"/>	Auto Shift <C
Bottom Silk Screen	<input type="checkbox"/>		PDF	Layer Silkscreen Bottom	1.000	Auto Rotate	<input type="checkbox"/>	Auto Shift <C
<Through Hole>	<input type="checkbox"/>		Excellon	Layer Span <Through Hole>	1.000	Auto Rotate	<input type="checkbox"/>	Auto Shift <C
SVG	<input checked="" type="checkbox"/>		SVG	Layer Top Electrical	1.000	Auto Rotate	<input type="checkbox"/>	Auto Shift <C
				Layer Silkscreen Top				

Outputting to ZIP Format

Should you wish to save the whole set of manufacturing exports to a compressed **ZIP** file, you can do this in the CAM Plot dialog. On the **Plot Settings** page, there are three check boxes:

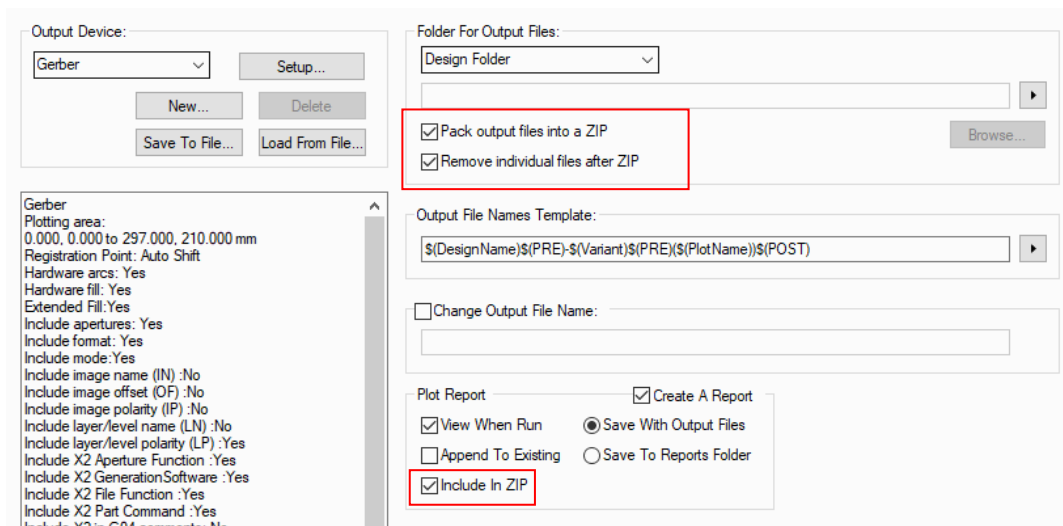

Output Device: Gerber [Setup...]
New... Delete
Save To File... Load From File...

Folder For Output Files: Design Folder [Browse...]

Pack output files into a ZIP
 Remove individual files after ZIP

Output File Names Template: \$(DesignName)\$\$(PRE)-\$(Variant)\$\$(PRE)\$\$(PlotName)\$\$(POST)

Change Output File Name:

Plot Report Create A Report
 View When Run Save With Output Files
 Append To Existing Save To Reports Folder
 Include in ZIP

Gerber
Plotting area:
0.000, 0.000 to 297.000, 210.000 mm
Registration Point: Auto Shift
Hardware arcs: Yes
Hardware fill: Yes
Extended Fill: Yes
Include apertures: Yes
Include format: Yes
Include mode: Yes
Include image name (IN) :No
Include image offset (OF) :No
Include image polarity (IP) :No
Include layer/level name (LN) :No
Include layer/level polarity (LP) :Yes
Include X2 Aperture Function :Yes
Include X2 Generation Software :Yes
Include X2 File Function :Yes
Include X2 Part Command :Yes
Include X2 in G04 comments :No

Check **Pack output files into a ZIP** to create a ZIP of all the generated output files in the folder specified in the **Folder for output files** section.

Check **Remove individual files after ZIP** to delete all the individual output files created, leaving you with the ZIP file only.

In the **Plot Report** section, check **Include in ZIP** under the **Plot Report** section to also add the CAM Plot report to the ZIP file.

Chapter 8. Outputting Reports, Part and Net Lists

Standard Reports

Pulsonix can generate a number of reports for which most vital aspects of the design can be reported in detail. The reports also include a set of Parts lists and bill of materials (BOMs). User defined Parts and Netlists can also be generated using the **Report Maker** option, this is discussed later on in this section.

The Standard Reports dialog

The Reports dialog contains both the built-in reports and any format files supplied with Pulsonix or created and saved by you. All built-in reports are designated with the word 'Report' as their suffix. These can be listed individually if required by selecting the **List Reports** check box. The list can also include **Format Files** found on the search path defined in the **Folders** dialog.

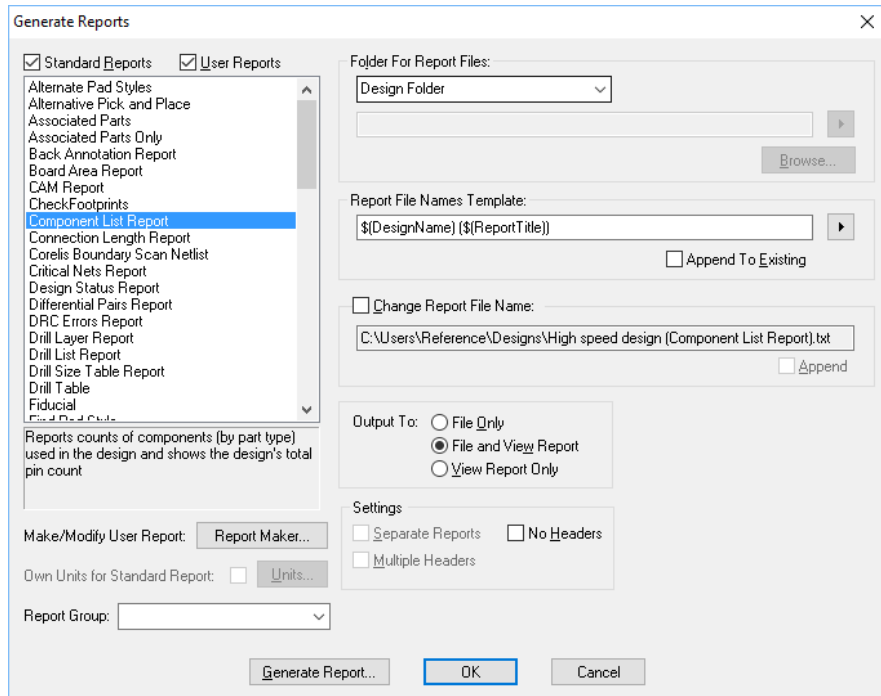

Each report can be run separately or all together by dragging the cursor over the list. Multiple reports can be run by picking each report required and holding down the **Ctrl** key at the same time.

To run a single report, double-click over the report name will act the same as pressing the **Generate Report** button on the dialog. Use **OK** if you wish to leave the dialog after generating the report.

Report Maker

Use this button to create or alter the format files that control the layout of the your own reports.

Report Maker

As well as the standard **Reports** mechanism, Pulsonix also provides you with a powerful **Report Maker** option for generating your own formatted reports and outputs. These can be reports, Parts lists, Netlists and any combination of Parts and Netlists, e.g. IPC-356 test format. These are saved as format files into the **Format Files** location specified in the **Folders** dialog.

Pulsonix is supplied with a number of format files to use and as examples of their layout.

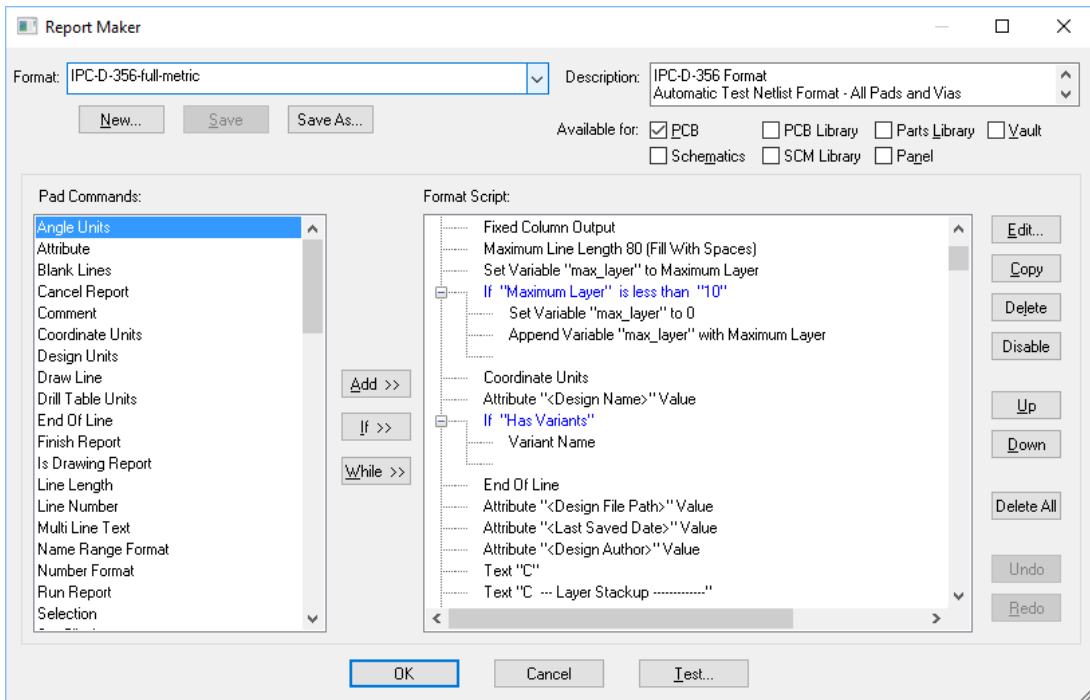

The dialog is broken down into a number of functional areas.

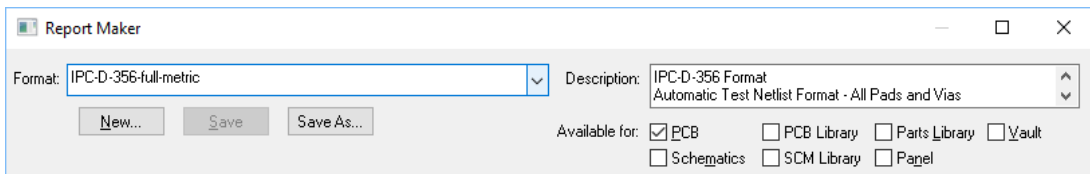

The **Format** drop down list is a list of all the available report files. These are found by the system using the search criteria from the **Folders, Format Files** page. **New**, **Save** and **Save As** are utilities for maintaining the format files. The **Description** entry is for labelling the format file. This description is displayed in the **Reports** option when the file is selected in the list. It is provided to give an indication of the activity of the file when run. Format files can be made to be available in either or both of the **Schematic** or **PCB** design editors by selecting their respective check boxes.

If you create a format file for both design types then later switch one of the type off, you may find that some commands do not appear on the selection. If used, these will be presented with a small red cross to indicate that they are unavailable for this design type.

The **Commands** are used to make up the scripts. The process is to select a command and add it to the **Format Script** area using the **Add>>** button or by double-clicking the command from the list. Commands are grouped in logical functions and in hierarchical design order importance, starting with general commands first and ending with specific item commands at the bottom of the list.

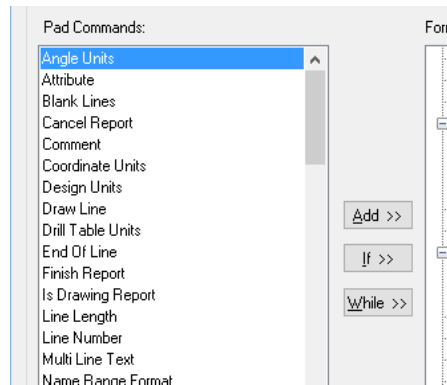

There are two extra buttons in the centre panel under the **Add>>** button are for inserting conditional operations to the commands. These are represented with **If>>** and **While>>**. The **Else** operator is inserted as part of the **If** command and is selected from that command's dialog along with other choices.

Once in the **Format Script** area, the commands are listed in a tree style.

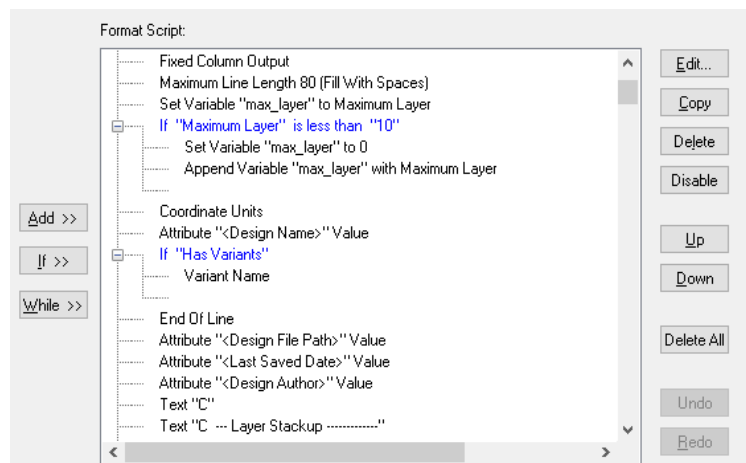

The buttons down the right hand side of the dialog control the Format Script items. When using the **Edit** button, the contents of the edit dialog will be in context of the item selected.

Using the Report Maker

The principle for using this dialog is to decide what output format you require. Make the selection from the Commands list that then writes the command to the Format Script list. Once in the list, apply the specific command format to the command and sort it in the order required to make the output format correct.

Initially, the Commands list will display 3 sets of commands related to the design. Each set of commands is separated by a thin horizontal line.

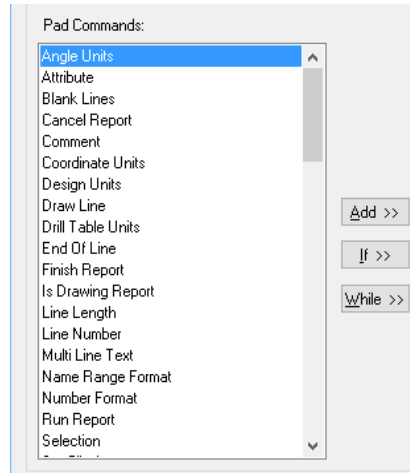

The first set of commands are general, and not specific to any context or command. These are always available for use in the script.

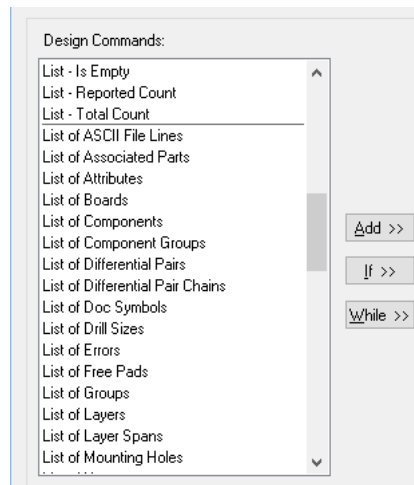

The second set of commands are the lists. These commands will be used to create the 'body' of the script. This is split into two sub categories, one for list variables for **List – Reported Count** and **List – Total Count**, and the other for listing items within the design, **components**, **Nets** and **Wires** etc.

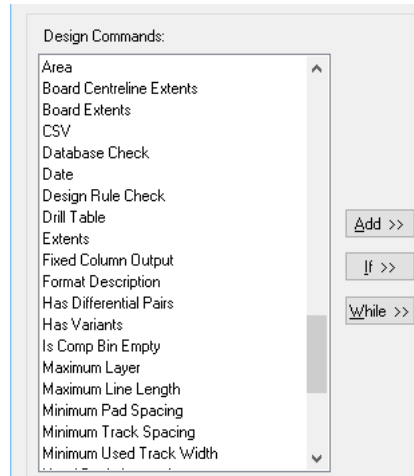

The third set of commands is always context sensitive usually dependant on the item currently selected in the Format Scripts list. The initial set presented is applicable to the design as a whole.

Picking one of the list commands and clicking **Add >>** will add it to the Format Scripts list, double clicking will also add it without having to use the Add >> button. For example, double clicking on the **List – components** will give you this:

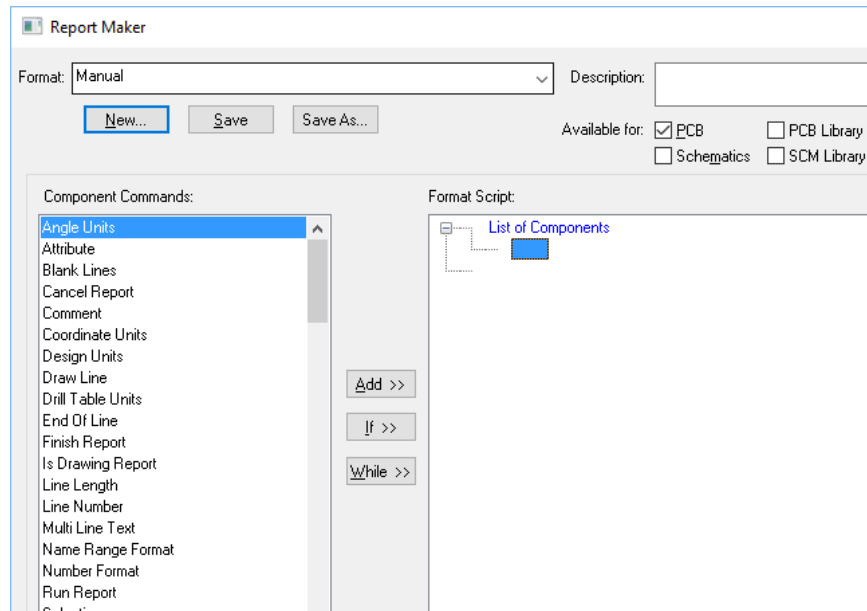

You can see that the List of Components is now available and is waiting for a command.

The Command list and is now changed to be context sensitive for the list of Component fields, shown with the heading **Component Commands**.

The Design commands are still available at the top of the list (as they always are), the middle list now shows List commands in context of what is available for components, and the bottom list are fields for items within the list of Components, such as Part Name etc.

Where you see a blue box you are expected to add a command from the list to complete the script in order for it to run. This box is only displayed when the blank line is selected. The extra blank ‘tree’ line under the blue box indicates the end of the command line.



If you selected this line (by default it is selected after adding the List command) and then selected the field **Part Name** and added it to the Format Scripts the format would now look like this:



By clicking the **Test** button at the bottom of this dialog you can try the script being created. If using the **Inter.pcb** design supplied with Pulsonix, the report would look like this:

```
C CP3 41612-M-64 3WP 5WP 26WDP 26WDP 3WP BC184L BC184L R R R R R8C R R
R R R R SPDT 74LS251 74LS251 74LS32 74LS125 74LS244 74LS244 74LS251
74LS244 74LS125 74LS251 74LS42 74LS244 74LS42
```

As you can see, the report is a list of Part Names from the design, there is no formatting as such and no filtering for specific names.

Ideally for a simple Parts list output you would add some Component Names and format the report into simple columns.

By selecting the Part Name field, the Component Name is promoted from the Component Command field list to the format script. It appears in the script under the Part Name field. As the Component Name field is still highlighted it can be moved up above the Part Name by using the **Up** button located on the right hand side of the dialog.

Formatting of the output file can be determined by using the **Edit** button (or double clicking) on the Part Name field. Because the Part Name appears after the Component Name, this will be the order that they appear in the output report.

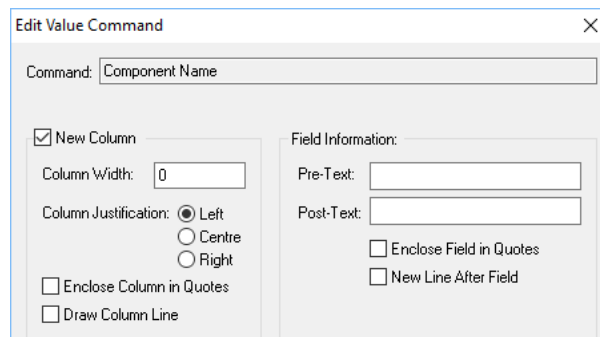

By selecting the **New Line After Field** check box, a new line is entered after the Part Name. As there is no formatting on the Component Name field this means that the report will now first find a list of components, then output the Component Name followed by the Part Name for each unique instance, then start a new line and report the next item.

The report now looks like this when the **Test** button is clicked:

```
C1 C
C2 CP3
CONN1 41612-M-64
PL1 3WP
PL2 5WP
PL3 26WDP
PL4 26WDP
PL5 3WP
Q1 BC184L
Q2 BC184L
R1 R
R2 R
```

This list can be formatted into evenly spaced columns even though the text fields are different sizes.

Again, using the **Edit** button, the formatting will need to be on both the Component Name and the Part Name. This means you would need to edit both items in the list.

For each field the **Column Width** would need to be defined and set. You would always need to allow enough space for the largest name in the list.

The screenshot shows a dialog box titled "Edit Value Command". It has a "Command:" field with the text "Component Name". Below this, there are two main sections. The first section, "New Column", has a checked checkbox, a "Column Width:" field with the value "10", and "Column Justification:" options: "Left" (selected with a radio button), "Centre", and "Right". There are also unchecked checkboxes for "Enclose Column in Quotes" and "Draw Column Line". The second section, "Field Information:", has "Pre-Text:" and "Post-Text:" fields, and unchecked checkboxes for "Enclose Field in Quotes" and "New Line After Field".

The report now looks like this when the **Test** button is clicked:

```
C1      C
C2      CP3
CONN1   41612-M-64
PL1     3WP
PL2     5WP
PL3     26WDP
PL4     26WDP
PL5     3WP
Q1      BC184L
Q2      BC184L
R1      R
R2      R
```

To add some headers to the formatted list you can add free **Text** before the List of Components statement. We've also added the **Underline** field and the **Blank Line** field. The Underline field will

look at the previous field and will automatically underline this field matching the field width. The underline character can be defined by editing this field. The Blank Line field will add a blank line (effectively a <CR>) to the report. The number of blank lines can be changed by editing this field.

As you can see, to make a header appear once at the start of the list all header fields must be on the same 'level' as the List of Components and must be above it.

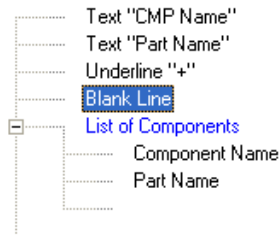

Both Text fields used could have been created using a single Text field with both headers spaced at the correct width. The disadvantage of using this method is that if any of the field widths under the List of Components are changed then you then have to adjust the text fields as well.

The report now looks like this when the **Test** button is clicked:

```

CMP Name  Part Name
+++++
C1        C
C2        CP3
CONN1     41612-M-64
PL1       3WP
PL2       5WP
PL3       26WDP
PL4       26WDP
PL5       3WP
Q1        BC184L
Q2        BC184L
R1        R
R2        R

```

The list can also be sorted. This is achieved by using **Edit** with the List of Components selected. By default the List of Components is sorted by Component Name first.

We will change this so that the Part Name is sorted first followed by the Component Name. This is achieved by selecting the **Sort By** check box and picking a field from the list provided. There are three possible sorting levels available. For additional sorting use the **Then By** check boxes. When sorting, the output can be sorted in **Ascending** or **Descending** order depending on the selection of the **Ascending Order** check box.

Command: List of Components

Sort By: Part Name Attribute:
 Ascending Order Use: X Coord Y Coord Value

Then By: Component Name Attribute:
 Ascending Order Use: X Coord Y Coord Value

Then By: Associated Part Quantity Attribute:
 Ascending Order Use: X Coord Y Coord Value

The report now looks like this when the **Test** button is clicked:

```

CMP Name  Part Name
+++++
PL3      26WDP
PL4      26WDP
PL1      3WP
PL5      3WP
CONN1    41 612-M-64
PL2      5WP
U4       74LS125
U9       74LS125
U5       74LS244

```

You can see that the Part Name 26WDP appears in the report with Component Name PL3 listed first followed by PL4, then the next **Part Name** with Component Names are listed, this is how the entire list is formatted.

Advanced Format Scripts

Adding **IF** and **ELSE** conditional statements to the format script adds further control on the data being processed. You can also add **Variable** fields to the script which can be combined with **WHILE** to test for data conditions.

IF and ELSE

IF statements can be added to test a field.

For our example we will test the List of Components to ensure that our Parts list does not contain any Schematics Only Parts. We will need to make the script look like this:

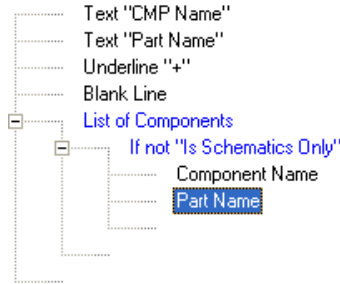

To achieve this you must go through a number of stages. You will need to select the Component Name field first. This puts the IF statement at the correct ‘level’. The test must be under the List of Components, so the script reads, “request a list of components”, “now test to see if the (List of) Components are Schematics Only”, “if they are not” then output “Component Name and Part Name (with formatting)”.

The **If** statement must be added below the List of Components. Select the Component Name field to do this and click the **If >>** button. The **Edit If Command** dialog is displayed. From this you can edit the commands to make the test condition.

For this example, on the **If** list we will select **Is Schematics Only** to test. We will test to see if **Schematics Only** Components **Is Not Equal to** and then a **Fixed Value** of **true** (so the test is for the Component not being Schematics only).

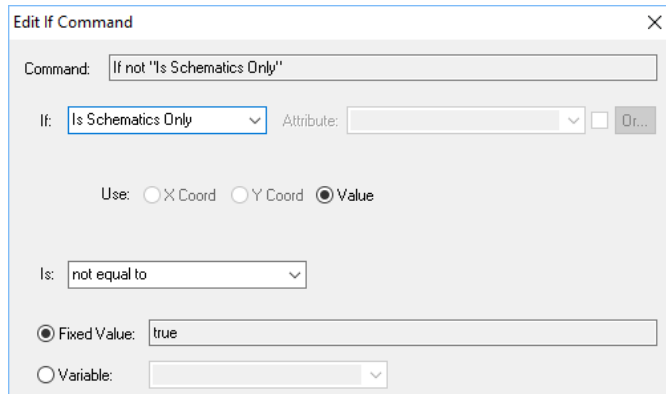

For the statement **Not Equal to TRUE**, you could also say use **Equal to FALSE**, in other words, test are they Schematics only? If not, output them, if they are, ignore them.

The script now looks like this:

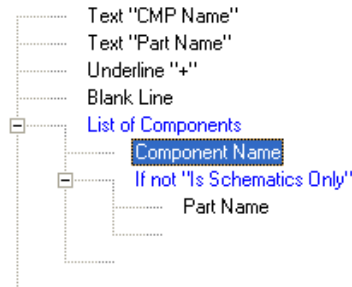

Because the If statement have been added below the Component Name field (you selected the Component Name field to get the IF statement on the correct 'level'), you must now use the **Up** and **Down** buttons to move the Component Name and Part Name fields to be under the IF statement.

Once the Component Name has been moved down you will notice that the Part Name is now on the wrong nested level. It must be under the IF statement but in-line with IF. Use the **Up** button to move it.

Note that the X “NEED COMMAND_HERE” message now disappears.

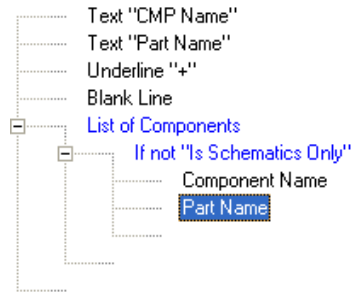

Using the Test button the report will now look pretty much the same as before (it is a PCB design which obviously can't contain SCM only components). Save the format file using the **Save As** button. It can be used on a Schematic design, Inter.sch for example.

The **Else** statement can also be used when using **If** to provide an alternative if the **If** test was not true. An example of **Else** is shown below.

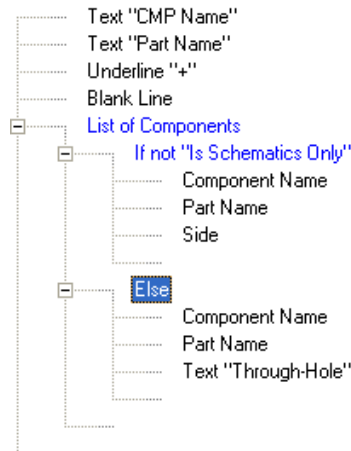

For our example file we've added another If statement to test whether the components are SMD (surface mounted devices) using **If "Is SMD equal to TRUE"**, and if they are we will first output the **Component Name, Part Name** and their **Side**. Then if the Component is not an SMD (tested using **Else**) we will output the **Component Name, Part Name** and a **Text** field, the text contains the words **Through-Hole**.

Our report now looks like this when the **Test** button is clicked:

```

CMP Name  Part Name
+++++
Q1        BC184L      Top
Q2        BC184L      Top
PL3       26WDP       Through-Hole
PL4       26WDP       Through-Hole
PL1       3WP        Through-Hole
PL5       3WP        Through-Hole
CONN1    41612-M-64    Through-Hole

```

Variables

Variables allow you to set a status on an item, then test that status and perform commands on it.

In the example below we have used a netlist output that will be driven from within the Schematic editor. Use the standard output file Net List.rff and Inter.sch if you wish to try this.

This script will output a netlist with the Net Name first then a list of pins on the net. By using the count variable, the number of pins reported per net name can be restricted to 4 per line, thus keeping them readable when viewed in Notepad.

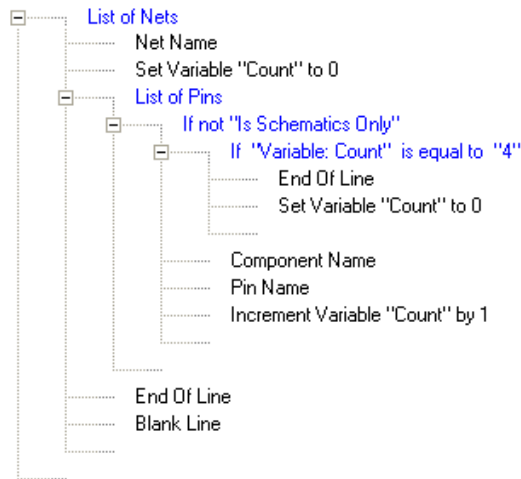

In this example we initially set the name to **count**, the **Variable Type** to **Integer** and a value of **0**. It will be set to an Integer, as the value reported back on use will be a count number. By setting the **Variable** before the List of Pins it can be tested for at any point after it.

Inside the List of Pins and following the initial test to see if the components are Schematics Only, the next test is to check to see if the Variable is 0. Initially it will still be set to zero until the script has run through one pass. The first pass will output the **Component Name** and **Pin Name**, the **Variable** will then **Increment the count by 1** and go back through the list again. It will do this for each **Component Name** and **Pin Name** of the same **Net Name** until the **count** of **4** is reached. It then performs an **End Of Line** and continues with the same net name. Once it has finished listing the **Component Names** and **Pin Names** for that net it starts a new **Net Name** after inserting an **End Of Line** and a **Blank Line**. The process then starts again until there are no more **Net Names**.

The **Edit Variable Command** dialog is used to set the **Variable Name**, its **Type** and **Value**. This dialog is also used to add and edit the **Increment Variable** command.

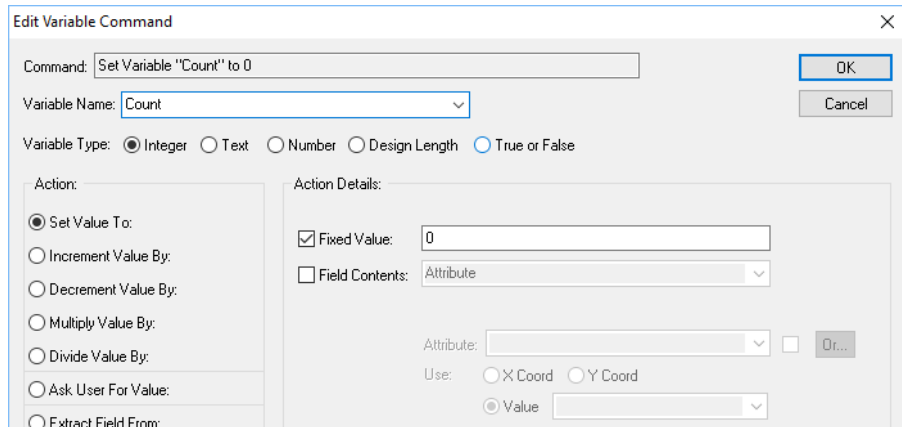

When the report is run it will be formatted like this:

```

Net COMPUTER
PL2.5      U11.4

Net GND
C1.2       C2.2       CONN1.1    CONN1.31
CONN1.33  PL1.1      PL1.3      PL3.12
PL3.24    PL3.25    PL3.26    PL4.12
PL4.24    PL4.25    PL4.26    PL5.2
Q1.1      Q2.1      SW1.2     U1.8
U2.8      U3.4      U3.5      U3.7
U3.9      U3.10    U4.2      U4.5
U4.7      U4.9     U5.10    U6.10
U7.8      U8.10    U9.7     U10.8
U11.8     U11.12   U11.13   U12.10
U13.8

Net ID0
CONN1.14  R5.2      U2.5      U5.11
U6.11     U9.6

```

The formatting is best demonstrated on nets with many pins, for example the GND net.

Chapter 9. Importing Designs and Libraries

Overview

Pulsonix supports the import of ASCII files for Schematic and PCB designs from other systems, as well as Symbol, Footprint and Parts libraries.

Fundamentally, there are two mechanisms available for importing designs and libraries:

- The first mechanism uses the Open dialog from the File menu to read in the design (the principle is much the same for the libraries but uses the Library Manager's management features),
- The second is using the Data Transfer Wizard also on the File menu, which handles the files. This allows you to choose the files to create (as well as designs, you could import a design to create a Technology File for example), and to choose the Source and Target locations for the files.

Both mechanisms have their own merits but in general, for an occasional user, the Data Transfer Wizard is recommended as it manages the transfer process for you.

Pulsonix also supports raw netlist files for import into its PCB design system, again using ASCII format files.

The diagram below illustrates the Design, Library and Netlist imports into Pulsonix.

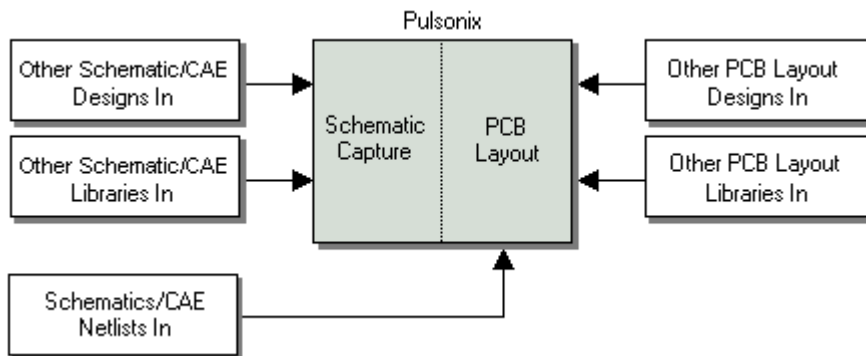

Importing Alien Designs

Importing designs into Pulsonix is an automatic process using the **Open** dialog. Once the source file has been located and selected, Pulsonix will detect the format of the ASCII file being imported and automatically open it.

Another method to import designs is simply drop their ASCII file on top of Pulsonix where it will automatically detect the format and open the import filter dialog.

Using the Open dialog

The Open dialog has selections under the **Files of type:** filter for all supported formats although it isn't necessary to use this unless you wish to only view in the list all the formats of one type.

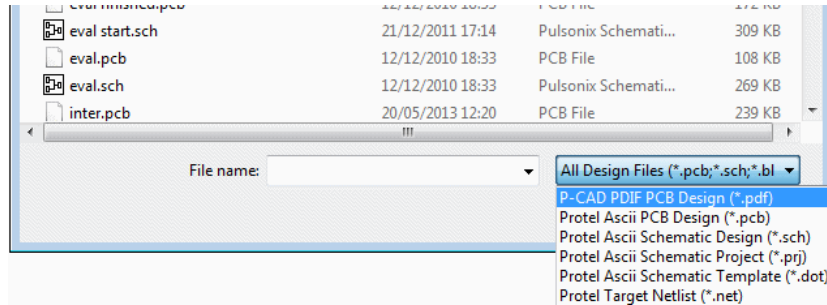

From the list of files to select you can make single selections or multiple selections if there is more than one file to import. Each file is treated individually during import will selections for Technology Files made on a design basis.

Once the File or Files have been selected, Pulsonix will read the file and check the format.

You are presented with a dialog from which to select a **Technology File** if required.

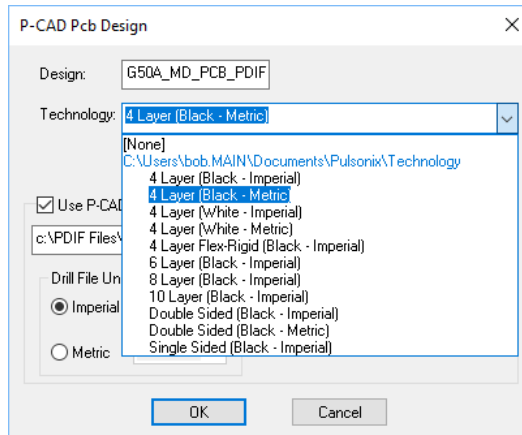

Unless you fully understand the implications of using a Technology File during this import you should select the [None] option. You can always use the Load Technology File option from the Setup menu at a later stage. This option would really only be used if the source design doesn't contain a full set of technology data for example (some vendors data doesn't contain the full set of technology data).

A report is generated during import. This report will contain the status of the design and whether the import was successful, it is import to view this report to ensure that the import has completed without any unexpected events. Where any changes to the imported data have occurred (changes to invalid characters, libraries unavailable etc), these will be written to this report.

Importing Netlists into Pulsonix PCB

If using another CAE or Schematic system a netlist may be available as an alternative to the Pulsonix Schematic translation or to adding the components and Nets on-the-fly into Pulsonix PCB.

Pulsonix PCB can import many format netlists from other systems. For a full and up-to-date list please consult the on-line help or the Pulsonix customer support desk, or the Pulsonix web site www.pulsonix.com

This process assumes that the netlist is derived from an external netlist source, created from another CAE or Schematic system or from a manually edited netlist created in a suitable format for reading into Pulsonix.

Pulsonix expects a collated netlist with all duplicate net and Component names resolved.

During the import, the Parts used in the netlist will be loaded from the existing Parts/Footprint libraries. If these Parts don't exist, an error will be displayed. All errors must be corrected to ensure 100% accuracy of the imported netlist.

If a Pulsonix Profile file has been used when creating the new PCB, you will need to either remove any components first before loading the netlist or use the **Import ECO option** after, to check the original netlist against the design and make any changes necessary to bring the two into line.

► How to add netlists to the design

1. Click the **File** menu, click on **Import Design Data** or **Open**. This facility can be used to start a new design or from within an existing design.
2. From the **Files of type** list available, select the format required. If unsure about the format, select the file anyway, Pulsonix will automatically recognise the import type. The Files of type list will help you filter the type of file required.
3. A standard **Open** dialog is displayed.
4. Select the netlist file required and click **Open**.
5. You will be presented with one of two possible dialogs depending how you entered this option.
6. If you entered from the **Import Design Data** option, this dialog will be displayed.

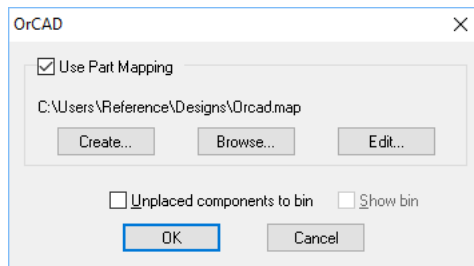

7. From the **Open** dialog you get the additional options of entering the **Design** name, the **Technology file** and the **Profile file** to start the design with. You can also select the **Unplaced Components** to the Component Bin and **Show** the Component Bin.
8. A **Part Mapping** file can be selected if the Part names and Footprint names don't match those used in the Pulsonix libraries.

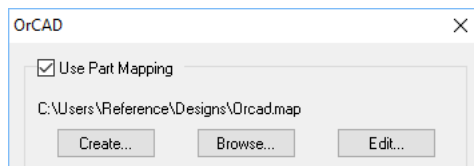

9. **Create** allows a new mapping file to be created if one doesn't exist. If a mapping file exists you can **Browse** to it to select it, or **Edit** the mapping file.
10. If you select **Edit**, the dialog is displayed:

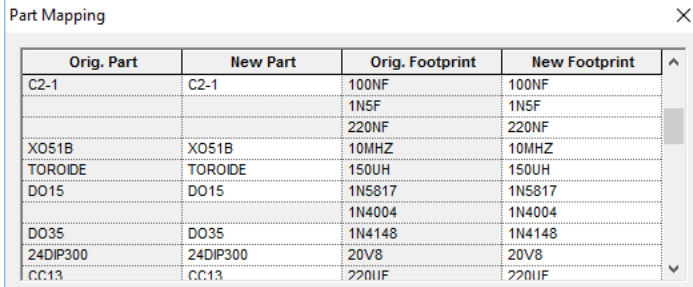

Orig. Part	New Part	Orig. Footprint	New Footprint
C2-1	C2-1	100NF	100NF
		1N5F	1N5F
		220NF	220NF
XO51B	XO51B	10MHZ	10MHZ
TOROIDE	TOROIDE	150UH	150UH
DO15	DO15	1N5817	1N5817
		1N4004	1N4004
DO35	DO35	1N4148	1N4148
24DIP300	24DIP300	20V8	20V8
CC13	CC13	220UF	220UF

11. You can specify two fields to map *to* and *from*. The **Orig. Part** and **New Part** specifies the original Part name and the new Part name. The **Orig. Footprint** and **New Footprint** options specify an alternative footprint if one is not defined in the original netlist or if you require using an alternative one.
12. Once the netlist is loaded any subsequent Schematic changes (ECOs) should be loaded into the PCB design using the **Import ECO** option.

Importing Other Formats

Importing Gerber files

Viewing Gerber files

The Gerber import option is used for viewing Gerber files before sending them to manufacture. You can also use this mechanism to read Gerber files created in other systems. Using the **Import Design Data** option on the **File** menu, you must have a PCB design open first. This can be a new design or existing design. This process is described in the online help.

Rebuilding Gerber files intelligently

The import of Gerber files can also be used to fully rebuild the design back to a full netlist and electrical connectivity with components. To do this, use the **Intelligent Design Data** option. have

The Intelligent Design Data option is also located on the **File** menu, you do not need to a PCB design open first. This can be a new design or existing design. This process is fully described in the online help.

Importing DXF files

The DXF import option is available for both Schematic and PCB designs although it is probably more useful with the PCB design editor.

DXF files can be translated into Areas, Boards, Copper, Doc Shapes, Templates and Text. The DXF data types that are imported are: Lines, Polylines, Arcs, Circles, Text and Hatching data. All other data types are ignored. If the allowable data types are included in Blocks they will also be translated. The translation of some closed shapes to be cutouts of other closed shapes is also allowed.

When creating PCB designs you may wish to import an existing board outline. This may be particularly useful if the outline is complex or critical. Specific mechanical drawing packages, such as AutoCAD, provide excellent 2D drawing capabilities where intricate shapes are produced. To aid this procedure, Pulsonix can read DXF files created in AutoCAD V10 and above. It can also read DXF files created outside AutoCAD provided they conform to the DXF standard as defined by AutoCAD.

Importing IDF Files

IDF files in the V2.0 and 3.0 format can be imported into Pulsonix PCB. V4.0 files cannot be imported yet as this is a relatively new format. IDF import also includes import of component placement data.

IDF is a neutral data format that can be exported from 3D mechanical design systems. Pulsonix can import Board outlines and cutouts, Area, components and Component Placement, Placement outlines, Placement keep in and out areas, all other area types (keep in and out) and Mounting Hole (IDF 3.0 format only) data from this format. IDF data is generally output as a board file and a library file. Pulsonix only imports the board file.

A Pulsonix design must already be open for the IDF import mechanism to work. The design can be brand new or can be a partially completed.

Importing STEP Files

Board outlines (and board cutouts), and Placement Sites in STEP format can be imported into your PCB design file using the **Import STEP Board** option from the **3D Design** menu.

Import Board

Use this option to import STEP data to assist with mechanical data in your PCB design. This can include a board outline created in your mechanical CAD package and exported in STEP format. You cannot import complete STEP models or positional changes, only a Board including Board Cutouts, Mounting Holes, and Vias. As it is a board only, the STEP file does not require any face, side or layer information. It also does not require a local origin.

By default, the system will try to find board shapes on XY plane. If they have been defined in another orientation you can choose the wanted plane from the dialog.

During import, it uses the best shape that it can find on the specified plane that encloses most of the other shapes in the STEP file.

By default, all units in STEP files are defined in mm. If your design is set as Imperial, during import, the units will be converted.

To import smaller circular cutouts as either **Mounting Holes** or **Vias**, simply input the maximum diameter of each, respectively, in the designated fields. When a circle is discovered that is smaller

than the specified mounting hole diameter, the circular element will be removed from the shape and a mounting hole will be created in its place, or a via if it is small enough for that. It assumes that mounting holes are bigger than via holes so it does the tests that way round.

Import Placement Sites

The positions of items in the STEP file will be used to insert **Placement Site** attribute positions in the design. These will only be added if they are inside a board outline in the design.

Choose from the Attribute Names listed in the drop-down list, or enter a new attribute name. You can also choose the text style from the list.

The Layer controls allow you to choose the layer on which the attribute positions should be placed. The Top Layer is used for all locations with $Z \geq 0$, and the Bottom layer for $Z < 0$.

You can also use the **Only Within Board** checkbox to choose whether or not to keep any positions that are outside all board outlines.

Importing Component Positions

The **STEP Positional Changes** option is also available to import a STEP file. Once the design has been placed in Pulsonix, this option can be used to read STEP files containing Component positional data. It will compare the current positions of the components with positions of the components as described in the STEP file. If there are any changes you will be asked if you want to apply the changes.

How to import DXF/IDF/Gerber files

► To add a DXF/Gerber/IDF files to the design

1. With a design already open, click the **File** menu, click on **Import Design Data**
2. Select **AutoCAD (*.dxf)** from the **File of Type** list or;
3. Select **IDF (*.idb)** from the **File of Type** list or;
4. Select **Gerber (*.gbr)** from the **File of Type** list or;
5. The file will be pre-processed to check its validity and to assess which contents and layers used.
6. The *format* **Import** dialog is displayed.
7. Check the **Use Map File** box if a mapping file is available or required.
8. Click the **OK** button to start the import.

How to import using the Intelligent Gerber option

► To use the Intelligent Gerber Import option

1. The above import mechanism doesn't work for Intelligent Gerber files.
2. For these, from the **File** menu, use the **Intelligent Gerber Import** option instead.
3. This procedure is fully described in the online help.

Chapter 10. Library Management Tools

Understanding Pulsonix Libraries

Pulsonix libraries are easy to understand and use once you grasp the basic concepts. Pulsonix has a **Parts library** made-up of elements from the **Schematic symbol library** and the **PCB footprint library**.

The following illustrations demonstrate the association between the different library types.

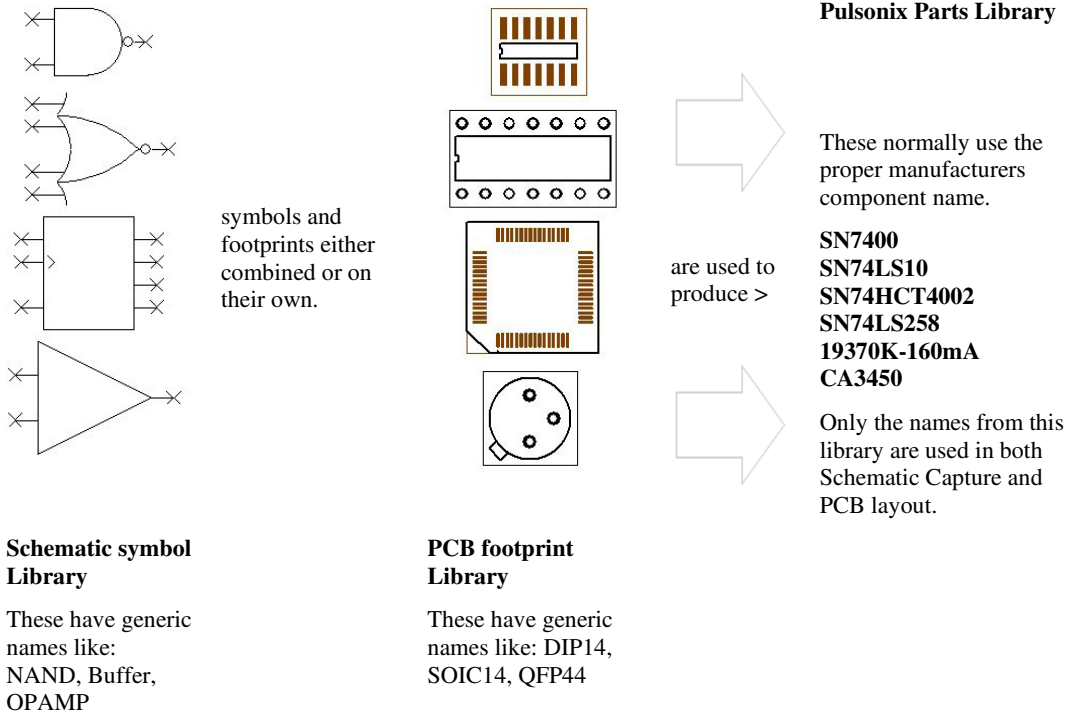

Schematic symbol Library

These have generic names like:
NAND, Buffer,
OPAMP

PCB footprint Library

These have generic names like: DIP14,
SOIC14, QFP44

Pulsonix Parts Library

These normally use the proper manufacturers component name.

SN7400
SN74LS10
SN74HCT4002
SN74LS258
19370K-160mA
CA3450

Only the names from this library are used in both Schematic Capture and PCB layout.

The benefits of a separate Schematics symbols, PCB footprints and Parts Libraries

In electronic design there are Schematic symbols and PCB footprints (usually defined on a manufacturer's datasheet). Commonly, integrated circuits and other components use the same physical package on the PCB, but have completely different internal digital or analogue circuitry and technical specifications. Take for example, the standard 14-pin DIP footprint:

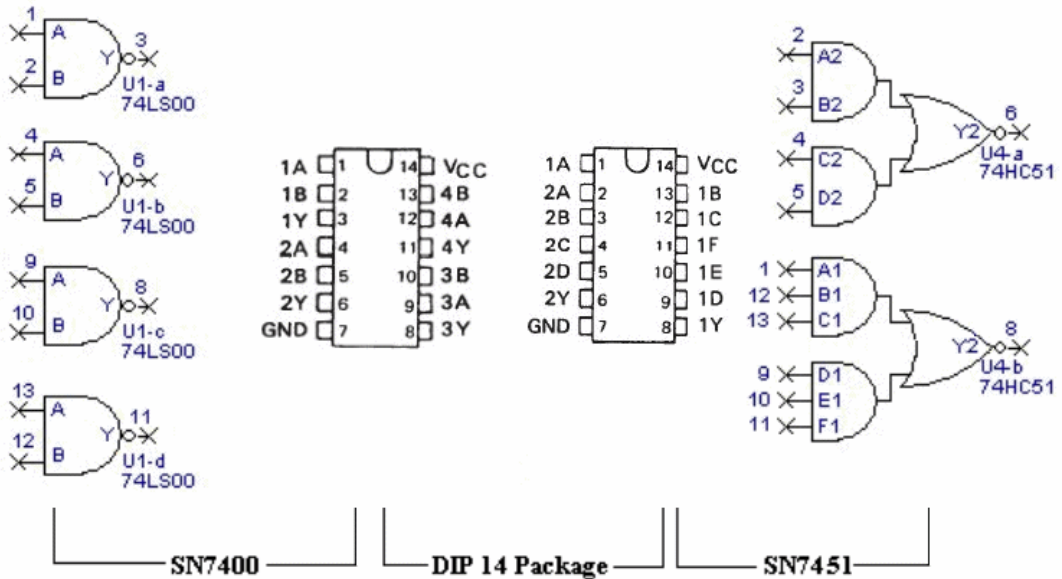

The 14-pin DIP (Dual Inline Package) is used on 100's of different components. For efficiency, we only want to store the 14-pin DIP PCB footprint once and then use it repeatedly to build different components or **Parts** that specify a 14-pin DIP footprint.

By the same token we only want to store a Schematic symbol once and use it repeatedly in various configurations to produce different Parts. Hence, we have a **PCB footprint library** to store a 14-pin DIP footprint plus any other footprints and a **Schematic symbol library** for a 2-Input NAND gate plus any other Schematic symbols. These can then be used on their own or be brought together (Schematic symbol & PCB footprint) in many different permutations to create a **Parts Library**. Multiple Parts libraries in Pulsonix are used to make the categorisation of Parts clearer, this can be done by manufacturer, type etc.

Key Point: In Pulsonix it is the only the Part name taken from the **Parts library** that is used in the Schematic Design and PCB Layout

As an example, this is how you go about creating a simple 7400 Part to use in a Schematic design and the PCB layout:

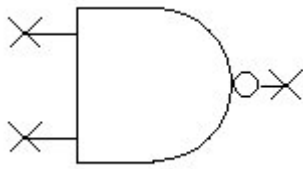

4x 2-input NAND gate symbol from the **Schematic symbol library**.

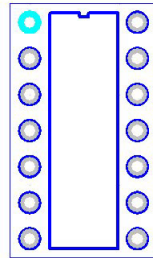

1x 14-pin DIP package from the **PCB footprint library**.

We can create a new 7400 Part by selecting 4x 2-input NAND gates from the **Schematic symbol library** and a 14-pin DIP footprint from the **PCB footprint library**. By combining these in the Parts Editor and inserting the correct pin mapping as per the data-book specification, we produce a **SN7400 Part**. This is then stored with a unique Part Name (SN7400 in this example) in the **Parts Library** ready to use in your designs.

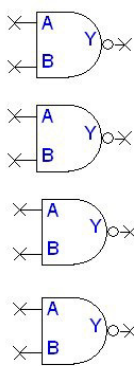

+

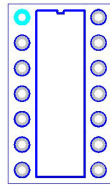

+

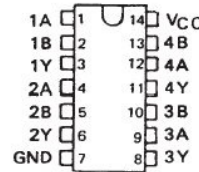
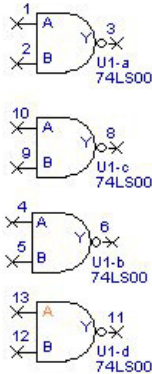

SN7400 Part



= This is stored in the **Part Library** as an SN7400 to be used in your designs.

Pin Mapping for 7400

Schematic only symbols without a PCB footprint?

You can create a new Schematic symbol and store it in the Symbol Library, but before you can use it you have to create a **Part** to 'hold' it. This is stored in the **Parts Library** for use in your designs. A schematic only Part may be a useful stop-gap while you decide which footprint type to use in the PCB layout, this information can be added later before the PCB stage is reached. If you wish to have symbol in your schematic that is not transferred to the PCB, then you can use a Schematic Doc Symbol instead.

Creating and using Parts and Symbols

Working this way, any Schematic symbol you produce is stored with an appropriate name in the Schematic symbols library. It can then be reused repeatedly to create different Parts using the manufacturer's Component names. Most Parts you produce will be the complete Schematic symbol and PCB footprint. Remember, the product you design is comprised of components with unique Part names and/or numbers, and your company may have it's own product code for this component.

This description of the Part usage for a symbol is easily demonstrated by considering resistors. Each range of resistors can use just one Schematic Symbol and one PCB footprint (can have more than one footprint if required). This principle is repeated for capacitors, diodes, transistors, inductors etc. this helps standardise and rationalise the contents of the libraries.

Creating and using PCB only footprint

This is exactly the same for PCB footprints as with Schematic symbols. Before you can use your new PCB footprint in a design you have to produce a Part even though this Part may not have a Schematic symbol associated with it. But again, this is a simple step.

On the following pages is a tutorial that goes through the steps of creating the following

A **Schematics symbol** – in this case a simple 2-input NAND gate

A **PCB footprint** – in this case a 14-pin DIL package

A **Part** – in this case a standard SN7400 to use in your design

Note: Standards for symbols vary from company to company. The tutorial is presented only as a means to understand the process of design and management and how to use the tools available. We recognise that the actual finished symbol, footprint and part may differ from your own standard. So, as you proceed you may wish to modify the visual appearances of the items to match your standards.

Libraries Overview

The illustration below shows how all the libraries fit into the Pulsonix framework. Although each library is shown as an individual entity, they are an integral part of the overall Pulsonix product and have only been shown separated for clarity. (Associated Parts are not shown).

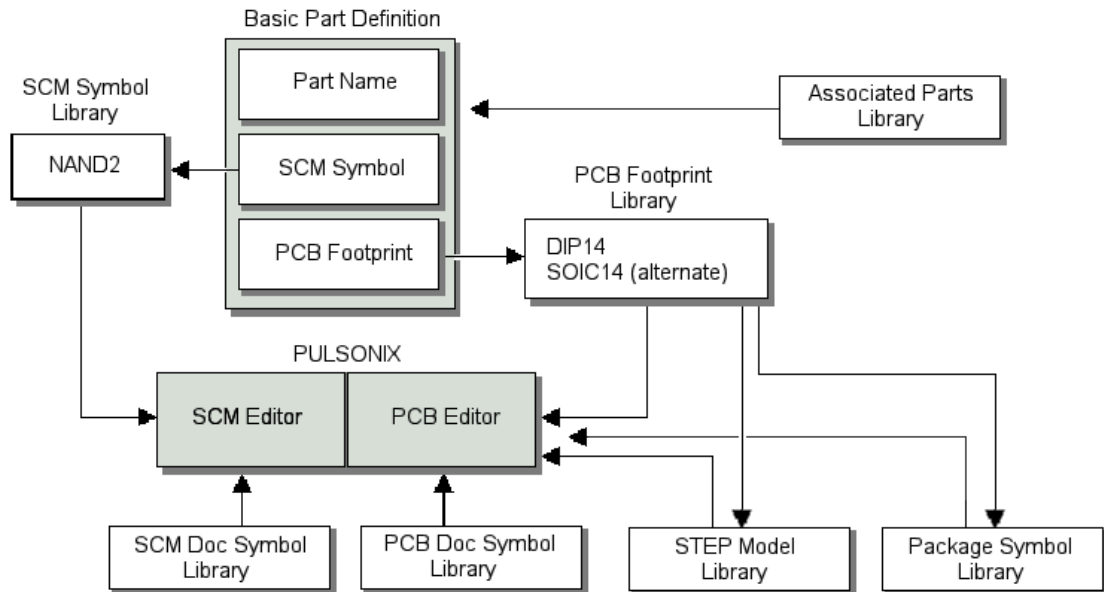

The libraries fall into two categories; **Parts/Symbols/Footprints/Associated Parts**, and **Documentation Symbols**.

There are five types of libraries:

- **Parts** – a Part contains the mapping between schematic gates and PCB footprints, as well as common properties. The Part is what gets added to both Schematics and PCB, thus ensuring that there is consistency between the two. A Part references graphics symbols, one is the Schematic

Symbol and the other is the PCB Footprint.

Note: A Part may also contain additional information such as an Associate Part data and Attribute information.

- Schematic Symbols – a Schematic symbol or gate is the graphical logical representation of the Part. This is seen in the Schematic when you add a Part. A Part may contain a number of gates that may reference the same (homogeneous) or different (heterogeneous) symbols.
- PCB Footprints – a PCB Footprint symbol is the graphical physical representation of the Part. This is seen in the PCB when you add a Part. A Part may reference a number of footprints as alternative representations.
- Documentation Symbols (SCM and PCB) – a documentation (doc) symbol is not used by a Part and does not require a Part, also it does not form part of the netlist. It is used for annotating the design, such as drawing blanks, power symbols, off-sheet references, PCB board outlines, logos, alignment markers, testpoints etc.
- Associated Parts – used to ‘attach’ additional Part detail to a Part. Associated Parts are not displayed in the design. These can be referenced from ‘real’ Parts available in the Parts library, or typed Part names that are not in the library but still associated to the Part.
- STEP Models – this is a library used by the STEP 3D Preview and export options.
- 3D Packages – this is a library used to define 3D shapes for use where STEP models do not exist.

For completeness of terminology, you also have a **Component**. This can be either a Schematic or PCB instance of a Part, that is, when a Part is used in the Schematic or PCB design it becomes a Component.

Part Attributes

A Part (as defined in the Parts library) can have a set of attributes that get inherited when the Part is used (as a Component) in the Schematic or PCB designs.

Overview of the Supplied Libraries

Pulsonix is supplied with a set of libraries containing Parts, Symbols, Footprints and Documentation Symbols. Your own STEP 3D models can be added to the libraries.

There are two sets of Libraries installed by default during the initial installation:

- Master Pulsonix Libraries (installed into Pulsonix\MasterLibraries)
- User Libraries (installed into Pulsonix\UserLibraries)

The **Master Library** contains the full set of installed libraries ready to use in your designs.

The **User libraries** are a set of empty libraries, one for each library type. These can be edited and added to, to create your own libraries. These are supplied to get you started using and are placed in a suitable location away from the master libraries as recommended.

User.pal	User Parts library
User.pfl	User PCB Footprint library
User.ssl	User Schematics Symbol library
User.sdl	User Schematics Documentation Symbol library
User.pdl	User PCB Documentation Symbol library

Index files

You may also notice files with the same library name but with an **x** at the end of the extension (hardware.palx), these are **index** files and are automatically generated by the Pulsonix library system as required. You can ignore these. They are automatically generated by Pulsonix as required so do not panic if you accidentally delete them. They are only updated manually if you wish to add additional attributes into the index for use with the **Parts Browser**. This is described more in the online help.

Conventions and standards used

All surface mounted footprints have been created to the IPC Council's IPC-SM standard and the JEDEC standards.

Additional Library Content

Pulsonix works with many specialised library content providers who can export their Part (with symbols and footprints) content in the .plx format. Currently, Pulsonix supports content from SnapEDA, PCB Libraries, Ultra Librarian, Collage and Samacsys. Other providers may also be available. Additional content is also provided through one of these suppliers via a manufacturers web site, such as TI, or Microchip, or a web site from component distributors, such as RS, Digikey, Arrows, Farnell etc.

The .plx ASCII file can be read by Pulsonix directly by dragging and dropping it onto the Pulsonix **Library Manager** where it will open a save dialog. From here, you can choose the destination library and the content to import. You may not always want all items, if the footprint already exists for example.

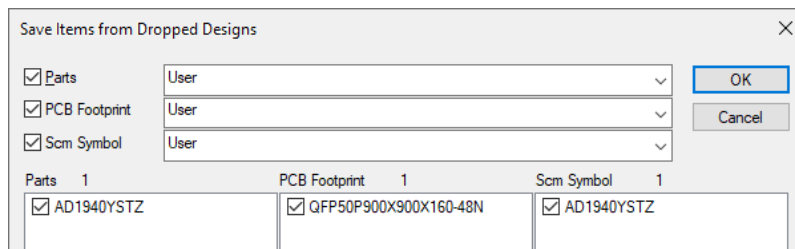

Your new item(s) will now be saved in your library ready for use.

Another note to make is that not all content providers supply all the Pulsonix library facets. For example, PCB Libraries may only supply a dummy Part name but an accurate Footprint created to IPC standard.

With external library contents, you can also 'mix and match' content. For example, import Part and SCM Symbol data from vendor A but import the footprint from vendor B, or use an existing footprint, or create it yourself.

The Library Manager

Overview

The library manager is used to create, edit and manipulate library files and library contents.

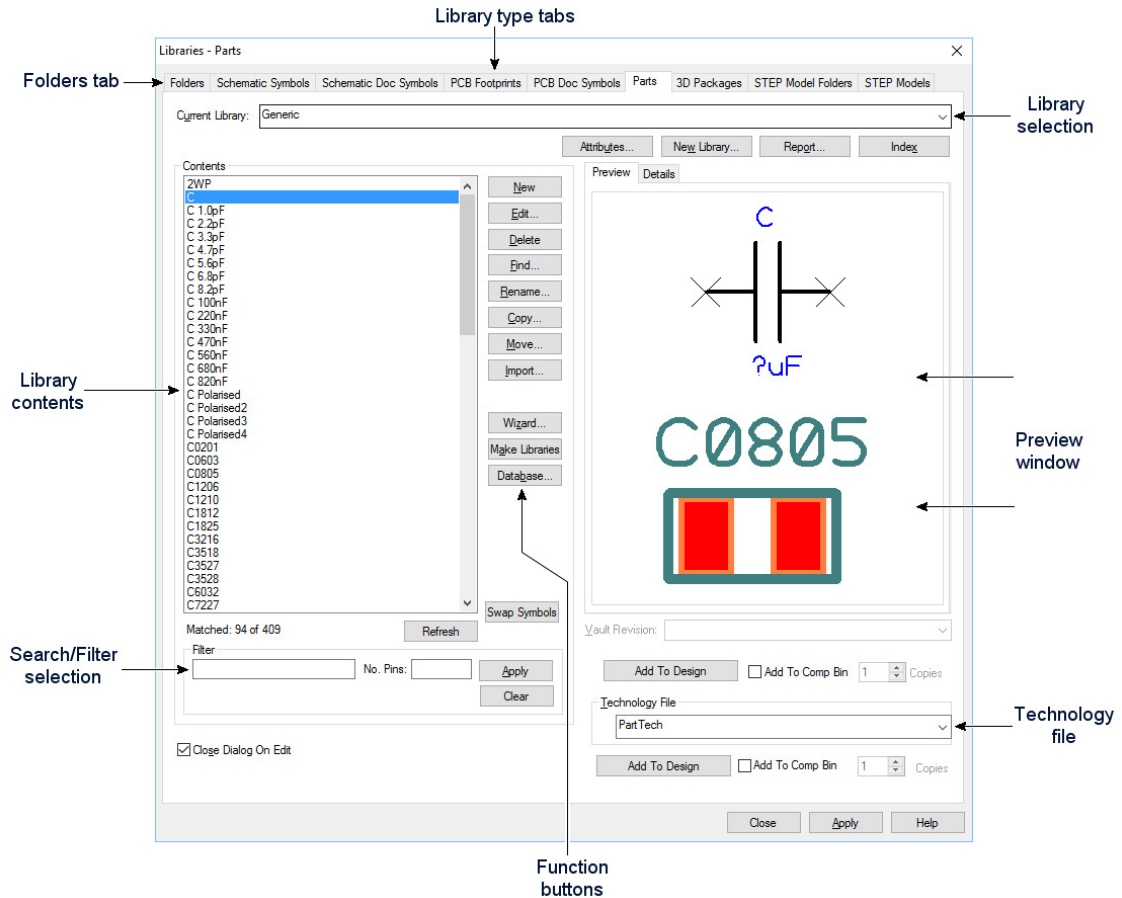

Library folders

The **Folders** tab is split into two main sections:

The upper area of the dialog shows the **folders** in which the application will **search** for the particular type of file. The lower area of the dialog section is for managing the library **files** within the folders. This page is available on both the **Libraries** and the **Folders** dialog from the **Settings** menu.

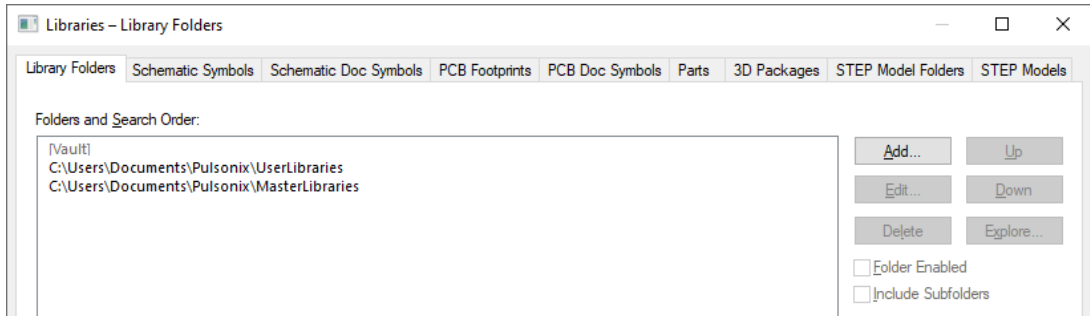

In the example shown, you can see that there are two folders specified for **Libraries**. When looking for files, the folders will be searched in the order shown in the list, you can use the **Up** and **Down** buttons to control the search order if you need to.

To add a new folder to the list, click on the **Add** Button. To edit an existing folder name, click on the name in the list and press **Edit**. Both buttons use the **Library Folder** dialog to set up the folder name.

To delete an entry from the folder list, select the name in the list and click **Delete**. You will be asked to confirm deletion of this name before the name is actually removed from the list.

Note: deleting an entry from the list will not delete any files, it simply removes the reference to that folder so that the application no longer searches the folder when looking for the particular type of files.

The lower part of the dialog shows the actual files found in the folders listed at the top of the dialog.

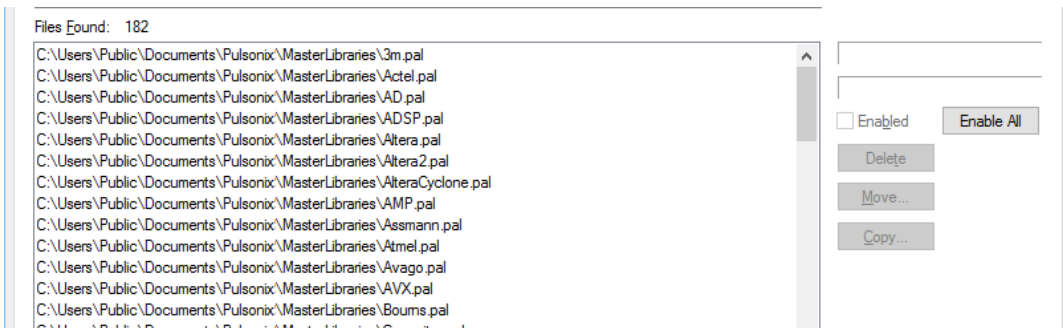

These are listed in the order they are found, so that you are able to see the actual order in which the application will search for information. This can be particularly important for Library files, as this allows you to see for example which libraries will be examined first when inserting new components into a design.

If Parts of the same name exist in the libraries the Library search order also becomes important in that the first instance of the Part found will be used in the design from Insert Component.

By selecting each library you can see which **library type** it is, and a basic **description** of the library contents.

You can set individual files so that the application *ignores* them, by clicking on the name of the file in the list and unchecking the **Enabled** checkbox.

The **Delete** button is for deleting the actual library file from the folder. A warning dialog is displayed when this button is selected which enables you to confirm the deletion first.

Warning: once the library file has been removed it cannot be undone or recovered.

The **Move** and **Copy** buttons are also provided to allow you to move or copy individual files to another folder. These can be used, for example, if you wish to take a backup copy of a file before making major changes to it.

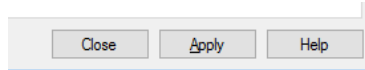

The **Close/Cancel** buttons are used to exit the dialog, these are displayed on all Library Manager pages. If a library change has been made but not saved, the **Cancel** button is displayed. If the change has been saved using the **Apply** button, the **Close** button is displayed.

Using the User libraries

Pulsonix is supplied with a set of libraries; these libraries reside in the **MasterLibraries** folder. In addition to this master set of libraries, there is also a skeleton library supplied named **User**, these are supplied in the **UserLibraries** folder.

*It is highly recommended that when using libraries you make copies of any library items and save them to the **User** libraries. If importing any libraries of your own, you should also create new or use existing libraries in the **UserLibraries** folder.*

Using the Library Manager

Each of the Symbol pages fundamentally work the same way, and to some extent (apart from the symbol preview window) so does the Parts page.

These pages are used for selecting the libraries to search (**Current Libraries**), selecting (**Contents**) and subsequently creating/editing/copying etc. the contents of the libraries. The **Filter** enables you to refine the search criteria that are displayed in the **Contents** window.

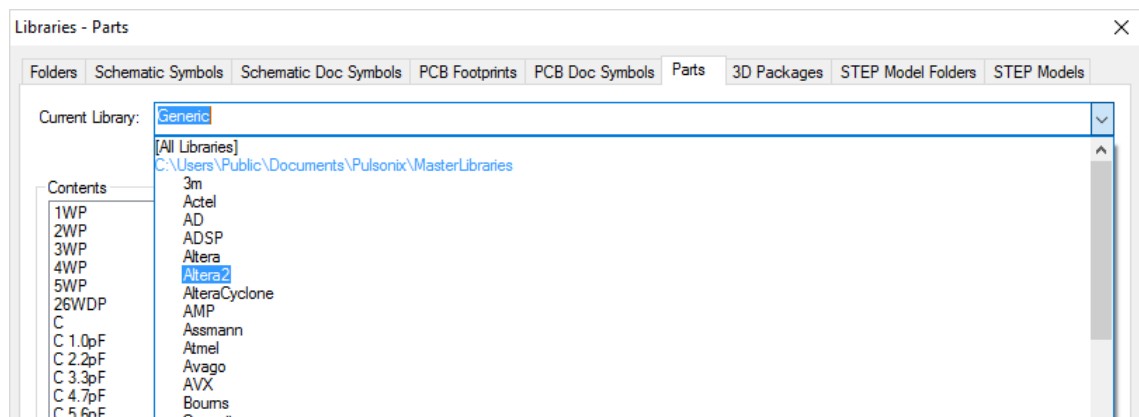

The **Technology File** selection is used when **New** symbols are created or existing symbols **Edited**.

The **Preview** window can be enabled to display symbol selected from the Contents window. When the **Part** page is selected, the **Preview** button is replaced with **Preview** and **Details** tabs. This provides you with either graphical or detail information about each entity of the Part selected.

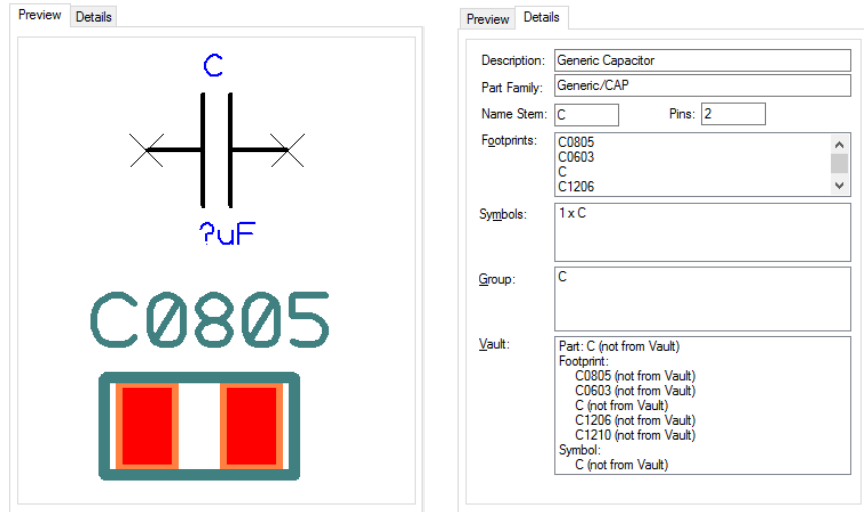

Library Selection

The top part of the dialog allows you to choose which libraries to view. The drop down list for **Current Library** will include all the library files found in the folders you specify on the **Folders** page.

Note: Any library files that are set on the Folders page as 'Disabled' will not appear in the drop down list. The list will only include 'Enabled' libraries, and the special entry <All Libraries> to allow you to view the contents of all the libraries at once.

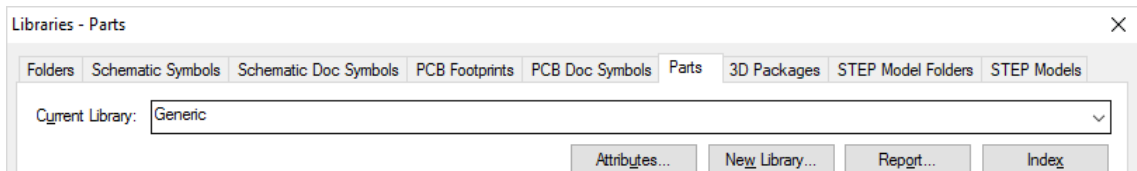

To create a new library, press the **New Library** button. A standard File Browser dialog will be displayed. Enter the name of the new library file and press **OK**. If you have chosen to create your new library file in a folder which is not in the list of folders, an additional dialog is displayed which will ask you to choose whether or not this folder should be added to the folder list.

Note: If you choose not to add a newly chosen folder to the list of folders, your new library will not appear in the list of 'known' libraries, and therefore any items added to that library will not be available either here in the Libraries dialog or when inserting new items into designs.

By selecting **Report** you are provided with a fill report of the names of the library contents for the selected library or if selected, All Libraries.

The **Index** button is used when a library is **Copied** or **Moved**. Libraries are indexed to allow fast searching and extraction of the relevant data.

Selecting Library Items from the list

The **Contents** area of the dialog shows the items contained in the library (or libraries) selected in **Current Library**, sorted into alphanumeric order. To help in finding the items you need, the list can also be 'filtered' to show those with names that match a particular pattern.

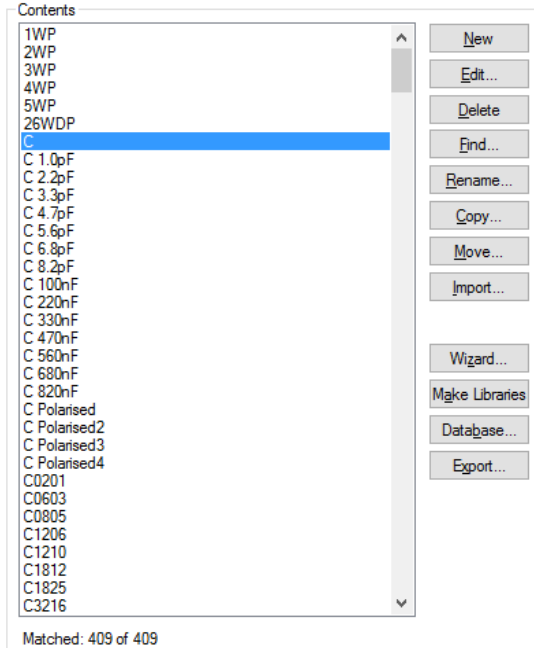

The buttons down the side of the Contents list provide the options needed to modify the library items. You can change the names of items, move or copy items to different libraries, or open items for editing. Most operations can be performed on one or more items. These buttons will be enabled or disabled depending on whether or not any of the items are selected.

Filter Selection

Use the **selection filter** to refine your current Contents selection.

You can combine the Filter **name** and the number of pins (**No Pins**) to filter the contents to be exactly what is required. These two fields can also be used individually to obtain the filter.

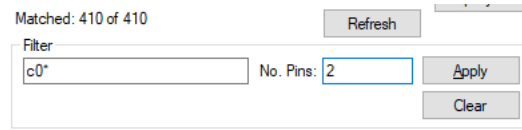

In the example above, the filter has been selected to be all items named **c0*** and with **2** pins. Wildcards can be used in the name selection.

The **Apply** button is used to apply the filter selection once entered.

The **Preview** section of the dialog optionally displays a picture showing the item currently selected in the list. Preview only works on a single selected item from the **Contents** list.

The **Technology File** specified at the bottom of the dialog will be used when the **New** button is pressed. For each Symbol type, the relevant Technology Files will be available, each showing its own file extension.

Merging Libraries

There are a couple of different ways to merge libraries; you can use the **Copy** facility and copy the contents of one library to another. Depending on how much of the library contents are selected this method is very much under your control. This method can, of course, be more error prone if you fail to select a library item. If all of a library is required, it may be easier to use the **Import** method.

By selecting a library file from the **Open** dialog during **Import**, you can import the complete library contents into another existing library.

Changing Symbol Types - To Symbol/To Doc Sym

The **To Symbol** and **To Doc Symbol** options are used in **Schematic Symbols** and **Schematic Doc Symbols** only. They are used to create a Doc Symbol from a Schematic Symbol and vice versa. This is especially useful where libraries have been imported from other systems and you wish to move library items from one type of library to another.

When you select this option, you are requested to choose the library for which to move the item to.

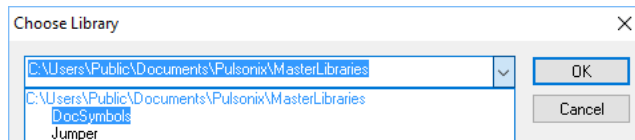

Once the destination library has been chosen, press **OK** and the library item(s) selected will be moved to this library as Symbols or Doc Symbols (depending on which mode was selected).

Creating Schematic Symbols

Schematic symbols can be created using the symbol Editor or the Symbol Wizard. For this exercise, we will use the Symbol Editor. The Symbol Wizard would be used normally for most types of symbols. In practical terms, the basic symbols already exist, so the wizard becomes useful for the creation of more demanding symbols, like 244 pin microprocessors for example.

By using an example, the following text will work through the creation of a common symbol and save it to the library. The example used will be a simple 2-input NAND gate, which will then be used to illustrate the Part creation mode later on.

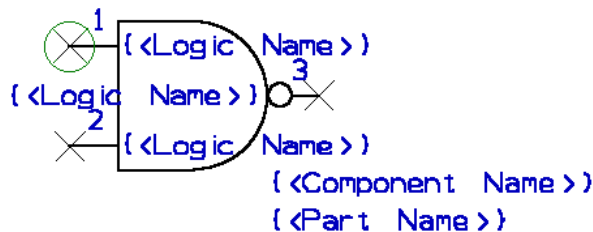

Using the Symbol Editor

Starting the Symbol editor

The **Schematic Symbol editor** can be invoked from the within the **Library Manager** using the **Schematic Symbol tab** and the **New** button. You can also invoke it from outside the Library Manager using the **New** option from the **File** menu.

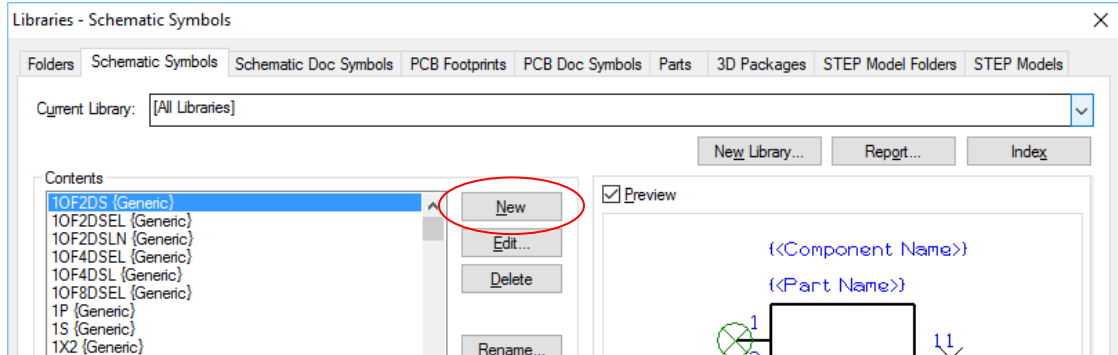

From the **Symbol editor** you can add Pins, Shapes, Attributes and Text to create the symbols. You also have the tools to save and rename the symbol as well renumber and automatically renumber the sequence of pins.

The symbol editor works in the same manner as the other editors within Pulsonix, except that there are some small variations to allow for the specifics of symbol creation.

When creating a new symbol, you can add pins or the symbol shape to make a start, it doesn't matter. For some symbols, it may be better to add the shape first then the terminals.

For our example, we will add the shape first then the pins.

To see the grid dots, we will need to zoom out a little to start with.

► Zoom out to view the grid dots

1. Roll the mouse wheel to zoom in a little or click <Z> so you can see the grid dots displayed.
2. The grid is set to 25 thou by default (as defined in the Technology file).

► To add the shape detail

1. When creating symbols, most of the commonly used commands are available on the **Schematic Symbol** toolbar shown on the left hand side of the design window.

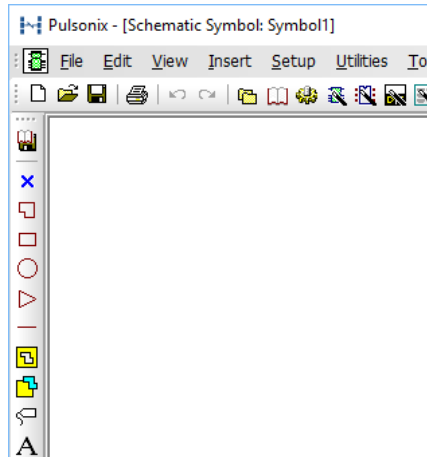

2. From the **Schematic Symbol** toolbar click **Insert Shape Rectangle**.

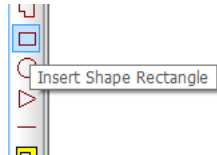

3. Hovering the mouse over the button will reveal the tooltip name.
4. Choose a starting point on a grid dot within the design window.
5. Click the left button to start and draw a rectangle to create a box 200x400 thou. Draw the box downwards. The status bar at the bottom of the design will confirm the size being drawn.

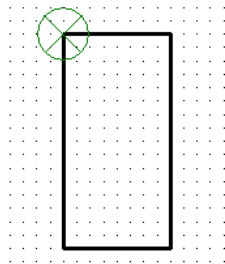

► To add an arc

The sequence below shows how to add an arc to one of the shape segments:

1. The shape must have straight lines with 90 degree corners (you cannot add arcs to non-orthogonal lines).
2. Select the segment, and right click.

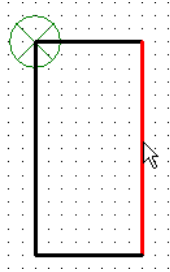

- From the context menu, select **Arc** and **Angle 180**. This will insert a semi-circle. If you wish the arc to have a smaller angle, choose one of the other options or use the **Edit** mode to create the exact size required.

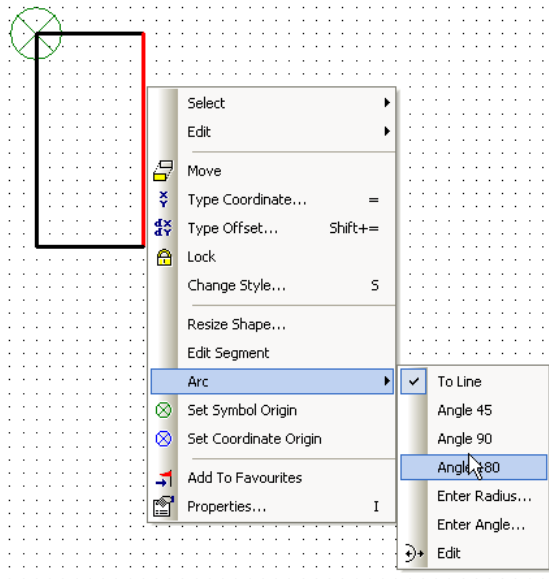

- If **Angle 180** is selected, the shape will look like this:

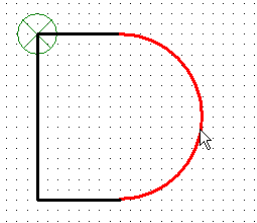

► To add the inverter circle

- The symbol requires a small 'inverter' circle shape for notation.
- From the **Schematic Symbol** toolbar, select **Insert Shape Circle**
- In free space, click and drag the circle to a radius of 25 thou. The radius will be displayed on the status bar.

4. Release the mouse to finish the circle.
5. Click the <Esc> key to exit this mode.
6. Select and drag the circle and position it at the front edge of the arc.

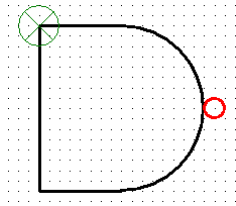

► **To add line segments**

1. We need to add short single line segments to create terminal extensions.
2. From the **Schematic Symbol** toolbar, select **Insert Shape Line**.
3. You need to add three short lines to the symbol.
4. On a start point 100 thou (4 grid dots) above the bottom left hand corner of the shape, drag a line 100 thou long (4 grid dots) to create a horizontal 'leg'.

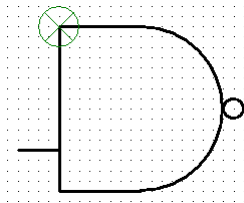

5. Double-click to finish.
6. Add a second line 100 thou from the top left corner of the symbol shape.

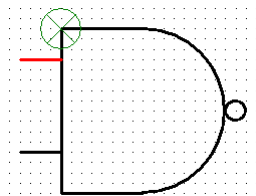

7. Now add the third leg to the right of the symbol.
8. This will only be 50 thou long and will be added to one edge of the inverter circle.

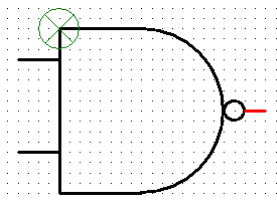

9. At this stage, there are still no electrical connection points. We will add these now.

Adding Pins

In order to make true electrical connections in a Schematics you must have a pin to connect to. When adding Pins (or terminals as they can also be called), the default values for the initial **Pin** added are taken from the **Design Settings** dialog and the **Defaults** page. This value is used if no terminal is already selected in the design.

The **Pad** and **Name Styles** are taken from the **Technology** data. The Pad style is used to define the shape of the terminal to be added and the Name style is used to define the name style of the pin number.

► To add a pin

1. From the **Schematic Symbol** toolbar, select **Insert Pin**
2. A pin will appear on the screen moving at the end of your cursor. If another pin was selected prior to entering the option, then the new pin's style and pin number position will be copied from it.
3. The pin will be allocated the next free pin number not already used in the symbol.
4. Position the first pin at the end of the line shape.

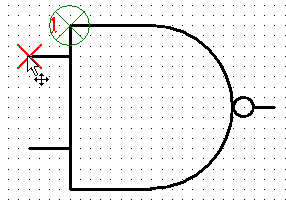

5. Once positioned, another pin using the same style, but with the next pin number will appear for you to place next.
6. Place all three pins.

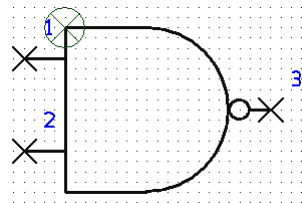

7. When all pins have been added, press the **<Esc>** key to exit the insert pin mode. The pin currently being moved will be deleted.

After adding all the pins the pin numbers may be dragged into more convenient positions. Right clicking on the pin will enable various characteristics of the pin to be changed using the menu items available.

If, when adding pins, you make a mistake or delete a pin you may then wish to change the pin number sequence. This can be done using **Renumber Pins** or the **Auto Renumber Pins** option from the **Utilities** menu.

► To position the symbol origin

1. You will notice that there is a green circle with a cross around it, this indicates the Symbol Origin.
2. The Symbol Origin is automatically added when the first design item was added. It can be moved interactively at any time during the symbol's creation. This will be the point used as reference when placing the symbol when used in the design.
3. By convention in the Pulsonix library, this will always be pin 1.
4. Select and drag the Symbol Origin, position it on pin 1.

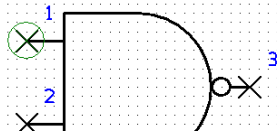

Adding Name Attributes

The Component and Part Name attribute locators are used to position the Component and Part Names when the symbol is used in the design.

The addition of the Component Name is different to that of other name attributes and both are detailed below.

► To add the Component Name attribute

1. From the **Insert** menu, select **Component Name**.

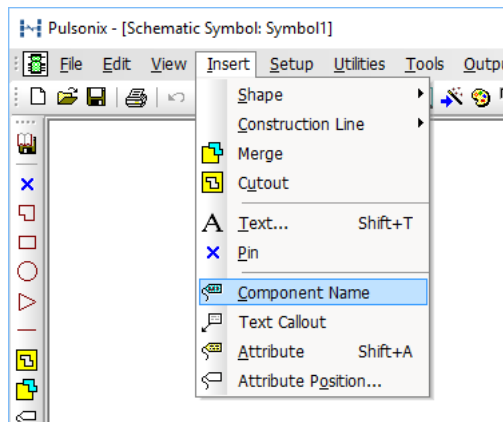

2. The Component Name attribute will be positioned on the end of your cursor ready for releasing on the symbol at the required position.
3. By default, this position is normally at the bottom right hand side of the symbol.

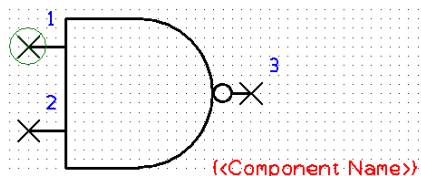

► To add the Part Name attribute

1. We will also add a Part Name attribute to show the process of adding attributes to symbols.
2. The Part Name does not have its own menu option but is instead added as a name attribute. This process would be the same if adding a Part Description or Symbol Name attribute etc.
3. From the **Insert** menu, select **Attribute Position**.

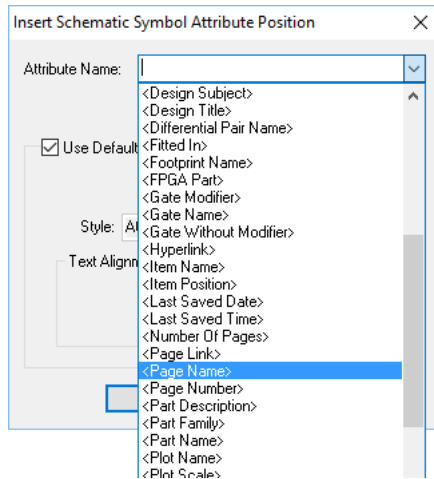

4. From the drop down list, select **<Part Name>**

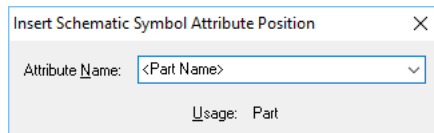

5. Click **OK**.
6. Position the name that is now on the end of your cursor.
7. By convention the Part Name attribute is placed under the Component Name attribute.

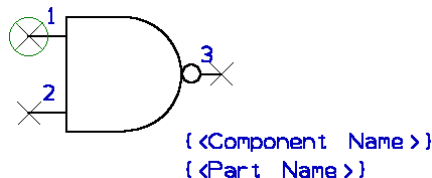

8. Once positioned, click the **<Esc>** key to exit this mode.

Saving the Symbol

Following these processes, the symbol is in a basic state where it can be saved for use within a design as part of a Part definition. This also assumes that when **Save To Library** is used, all pin sequence errors are resolved, although if in error, these will be flagged and the save not completed.

► To save the symbol

1. From the **File** menu or from the **Schematic Symbol** toolbar, select **Save To Library**.

- From the **Library** list, select the library in which to save the symbol.
- In the **Name** box, type in the name of the symbol.

Adding Other Attribute Detail

Other attributes, such as the **Logic Name** may be required on the symbol. These names can be added using the **Insert Attribute** option available from the **Insert** menu.

The **Logic Name** is attached a pin as a Pin attribute. This process is straightforward as if adding any other name attribute such as a Part Name (except that it is an attribute of a pin).

The **Attribute Value** is defined as a **Place Holder Only** because there is no value to satisfy the attribute. This will be satisfied once the value has been added to the Part definition and then subsequently used in the design.

Once the attribute has been added to the symbol you may wish to refine its characteristics. You can change the **Text Alignment** so that when the attribute is satisfied, the text has the correct bias relative to the pin. This would be the case for the Logic Name associated with Pin 3 of the 2NAND gate.

To achieve this, select the <Logic Name> attribute and select **Properties** from the context menu. Change the Text Alignment from the default of bottom left, to bottom right to make it name right to left. The final result will look something like this:

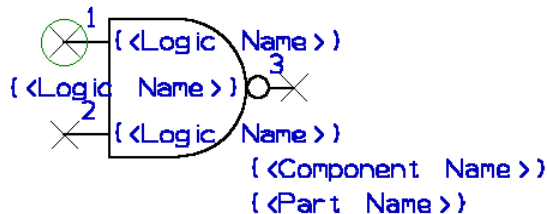

If you have followed this process, use **Save To Library** to save the symbol.

Decoupling Capacitors

There is no action for creating decoupling capacitors in the Symbol editor as they are ‘normal’ capacitor symbols but have special naming conventions when used in the design.

For more detail on how to use and name decoupling capacitors, please refer to the Chapter on the *Schematic Capture Editor* and the Section on *Decoupling Capacitors*.

Library Creation Wizards

Three Library creation wizards are available for the creation of **Parts**, **Schematic Symbols** and **PCB Footprints**.

The wizards break down the process of creating a new Symbol or Part into a series of steps. Each step is presented in turn on a separate wizard page. You would complete each step then move onto the next one until you reach the **Finish** page. At any time as you progress, the preview window will show you what your final Symbol or Part will look like.

The procedure for using this wizard is not fully documented here. Use of the wizards naturally guides you through the process with context sensitive help available for each page in the dialog.

Once the Symbol or Part has been created you can save it to a **Symbol/Part library**, providing its **Library Name** and **Name**. By selecting the **Edit the Symbol/Part now** check box, you can directly load the new library item into the relevant item editor. For each of the Schematic Symbol and PCB Footprints, you can also **create a new Part** and save it to a named library using a name provided. As with the Symbols, you can elect to **Edit the Part now** using the Parts editor.

Creating PCB Footprints

Starting the Footprint editor

The **PCB Footprint editor** is used for creating **PCB Footprints**. It can be invoked from the within the **Library Manager** dialog using the **PCB Footprint tab** and the **New** button. You can also invoke it from outside the **Library Manager** using the **New** option from the **File** menu.

Using PCB Technology Files with the Footprint Editor

If you use the **New** option from the **File** menu you can select the **Technology File** to use when creating the Footprint. Pressing **OK** will start a new Footprint creation session in the Footprint editor.

If you use the **New** button from the **Library Manager** dialog, you are entered directly into the Footprint creation editor using the **Technology File** specified on the dialog.

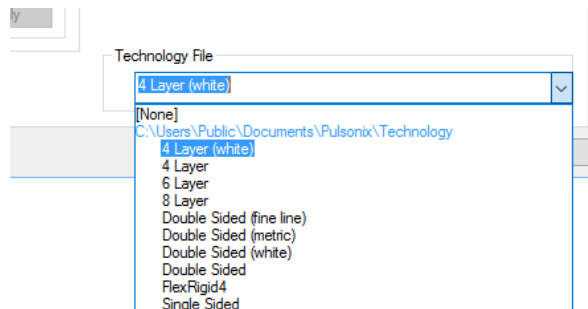

The drop down list enables you to select the **Technology File** to use.

Setting up Technology data

Technology Files within the Footprint editor have exactly the same use as when used in the PCB design editor and as such, should be the same for both. If you create your footprint using a new Technology File or you create or edit one while in the Footprint editor, you should save it for use in the PCB editor.

The diagram below illustrates how each of the style tabs relates to items within the PCB footprint.

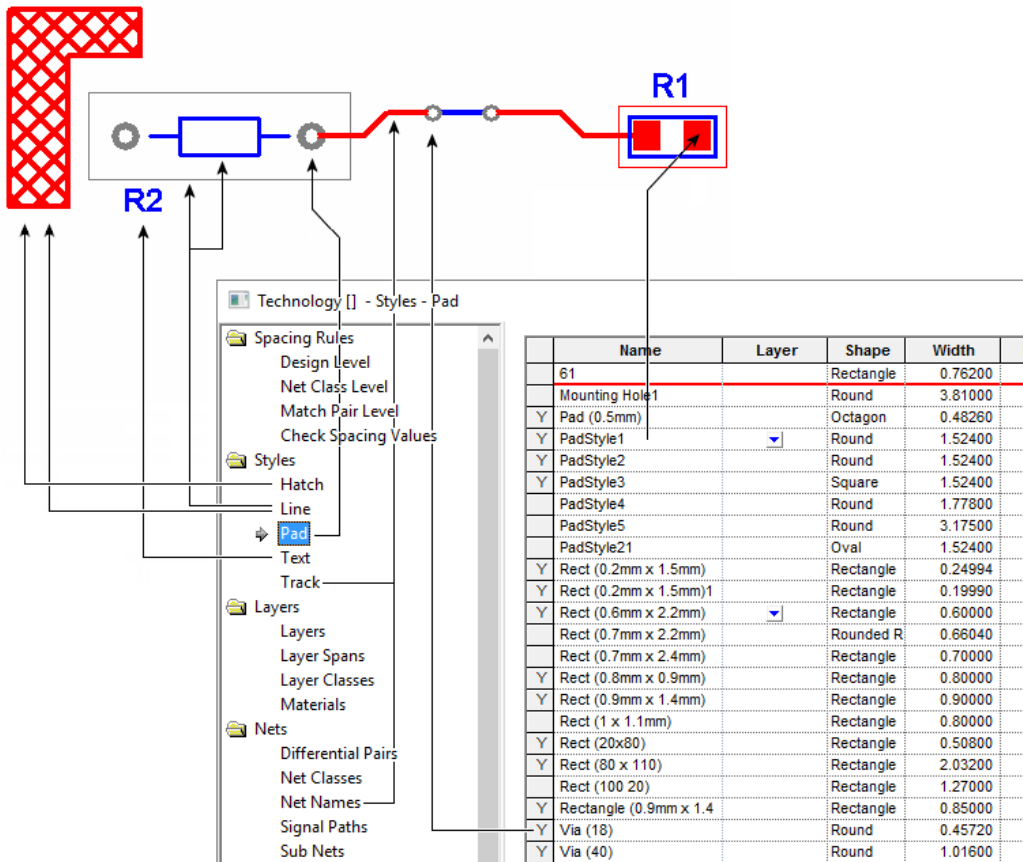

Technology Files for PCB have been discussed in the earlier *Chapter on General Utilities* under *Technology Files* and the *Chapter on PCB Design Editor* under *Setting Up A Technology*.

Using the Footprint Editor

From the Footprint editor you can Insert Pads, Mounting Holes, Copper, Shapes, Attributes and Text to create the footprint. You also have the tools to save and rename the Footprint as well as tools to renumber and automatically renumber the sequence of pads.

The footprint editor works in the same manner as the other editors within Pulsonix, except that there are some small variations to allow for the specifics of footprint creation.

By using an example, the following text will work through the creation of a common footprint and save it to the library. The example used will be a simple DIP14 footprint, which will then be used to illustrate the Part creation mode later on.

Inserting Pads

The first item to add in the creation of the footprint is the electrical connection point or pad. Pads in a PCB design are 3 dimensional. That is, they occupy a layer but also occupy a pad 'stack' through each layer of the design. These pad stacks are catered for inside the Technology itself using Pad styles.

The pads chosen for any footprint should be selected based on the final manufacturing requirement or your company standards.

When using **Insert Pad** option, the default **Pad** size used will be taken from **Design Settings** dialog and the **Defaults** tab.

While adding the pads, you can use the **Change Styles** option from the context menu to change the style of the current pad.

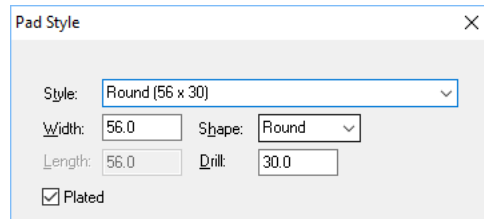

► To add pads

1. From the **Insert** menu, select **Pad**.
2. A pad will appear on the screen moving at the end of your cursor. If another pad was selected prior to entering the option, then the new pad's style and pad number position will be copied from it.
3. The pad will be allocated the next free pad number not already used in the footprint.
4. To change the grid step, or work with no grid, use the **Change Grid** option. It is better to use a grid that will represent the grid used in the design when placing footprints. The grid step should also be chosen which most closely provides you with the pad pitch (the distance between the pads).
5. Move the pad to the correct position and click to release it. Another pad using the same style, but with the next pad number will appear for you to place next.
6. When all pads have been added, press the <Esc> key to exit the Insert Pad mode. The pad currently being moved will be deleted.

After adding all the pads the pad numbers may be dragged into more convenient positions. Right clicking on the pad will enable various characteristics of the pad to be changed using the menu items available.

With the first pad added, the footprint will start off looking like this, notice that the pad has been placed on the grid point:

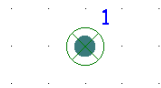

The grid points can be the visible **Screen** grid dots and the **Working Grid** which is what the Insert Pad option will default to.

Once more pads have been added, the footprint will start to take shape:

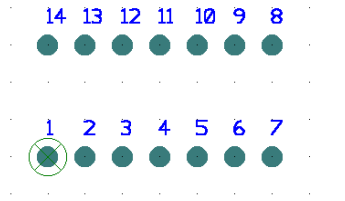

The pad numbers can be moved around for clarity.

Tip: Move the number on the first pad and then select the pad. With the pad selected, click Insert Pad. The next pad will now take on the properties of the selected pad, including the pad number position and style.

Pad Reassignments

Pad stacks that require a different pad style (size or shape) on different layers must be defined in the Technology under Pad Styles using the **By Layers** button. Because pads are created as a ‘stack’ with a single definition of all the layers you must make a different reassignment for any differences required.

The Footprint Symbol Origin

You will notice that Pad 1 has a circle with a cross around it, this indicates the Footprint origin. This origin is automatically added when pad 1 was added but can be moved interactively at any time during the footprint’s creation. This will be the point used as reference when placing the footprint on the design. By convention in the Pulsonix library, this will always be **Pad 1** for through-hole devices or the footprint centre on surface mounted devices. The footprint origin is always added with the first item not just when pad 1 is added.

The **Footprint Origin** default position is taken from the **Design Settings** dialog under **Defaults**.

Renumbering Pads

If, when adding pads, you make a mistake or delete a pad you may then wish to change the pad number sequence. This can be done using **Renumber Pins** or the **Auto Renumber Pins** option from the **Utilities** menu.

If using the **Renumber Pins** option you choose the **Start Pin Number**. You can start at pad one or you can start at any point in the number sequence if renumbering from where there is a gap for example.

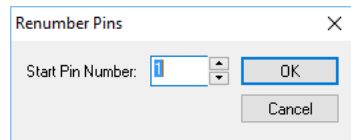

Each time you select a pad, the current pad number in the sequence is assigned to that pad, and the sequence number is incremented. So, for example, if you began the renumber sequence a **3**, the first pad you select will be numbered **3** and the sequence number incremented to **4** ready to select the next pad.

It is possible to get into the situation where more than one pad has the same sequence number. This situation must be rectified before the footprint can be saved to a library. The program will not let you save the footprint with duplicate pad numbers.

You might want to consider using **Auto Renumber Pins** which provides an automatic way to ensure the pads are legally numbered, and can be numbered according to their physical location. This may be a better option if you have many pads to renumber.

Mounting Holes

Although for our example mounting holes are not used they are worth mentioning here.

After adding pads to the footprint you may wish to add mounting holes. Mounting holes differ from normal pads in that they are not sequentially numbered (in fact they are not numbered at all). This means they don't appear in the pad count when using the footprint during the creation of Parts in the Parts Editor. However, because they are pads, they can be connected to, for grounding purposes for example, but they don't appear in any netlist.

When adding mounting holes to footprints in the Footprint editor, they should be added last, after the normal pads.

Mounting holes take their **default** styles from the **Design Settings** dialog and **Mounting Holes**.

► To add mounting holes

1. From the **Insert** menu, select **Mounting Hole**.
2. A pad will appear on the cursor. Position the pad and click to release it.
3. As with normal pads, the mounting-hole pad style can be changed by using the **Change Style** option on the context menu.
4. When the mounting holes have been positioned, press the <Esc> key. The pad currently on your cursor will be removed.

Inserting Shapes

Inserting shapes to a footprint uses the same process and editing options as if adding a shape to a design. You are able to add shapes for Copper, Shapes and Areas. All shape types in the Footprint editor are layer specific and will follow their default values as defined in the **Options** dialog under **Defaults**, (each of the pages for **Area**, **Copper** and **Doc Shape** are the same except that some of the options are only available where appropriate for some shape types).

Using a right click of the mouse will select options that will assist you adding or editing the shape. The context menu will also allow you to make the choice of how the shape is presented, e.g. Open/Closed, Filled/Unfilled and Hatched/Cross Hatched etc.

► To insert a shape

1. From the **Insert** menu click **Shape type**
2. Choose from the three shapes available (**Polygon**, **Rectangle** or **Circle**)
3. Draw the shape required.
4. Change the **Layer** and **Style** if required using the options from the context menu.
5. Double-click to finish the shape.

For most footprints there may well be more than one shape and more than one type of shape used, these will require use of the different shape types.

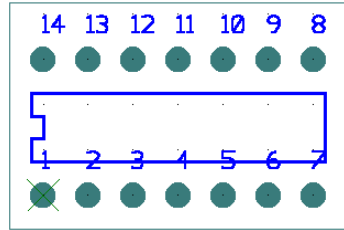

In the example above, the inner shape is a Silkscreen outline placed on the Silkscreen Top layer. The outer shape is a placement outline that is placed on <Through Layers> so that it appears on all layers and is considered on all layers during placement. For SMT devices, you may well have the Placement outlines only defined for a given layer, e.g. Top Electrical.

You may also wish to add an additional shape that appears only on Assembly layers for example.

Placement shapes

Placement outlines are drawn as **areas** and are specifically defined in the **Area Properties** as being **Placement Clearance areas** using a check box.

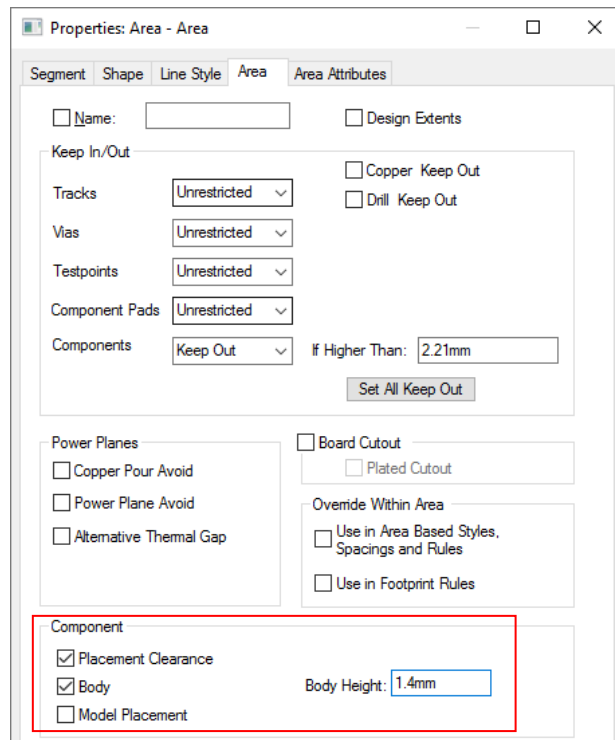

There are three types of component areas:

A **Body** area defines the ‘actual’ shape of the physical Component body and is used for example, to determine if a testpoint is under a Component.

A **Placement Clearance** area defines additional space around a Component. For example, to allow for the full opening of placement machine jaws.

Clearance areas on different Components may overlap, provided that any Body areas are legal but Clearance areas and Body areas may not overlap. When using Component pushing, it is the Component Body area and Clearance area of the other Component that are used. Where Clearance areas are not used on Components, the Body area is used for the pushing boundary and Component to Component spacing. Where a Body area has not been defined for the Component, the component bounding box (calculated by Pulsonix) will be used.

The **Body Height** value is used for **Component Height checking in DRC** and for when the **3D Viewer** feature is used.

If the area is used when a component has a STEP model assigned to it, the **Model Placement** will identify the area for alignment with the STEP model.

Additional Component to Component spacing is applied between Body areas and not to Clearance areas.

If placement outlines have not been defined, the Component bounding box will be used.

A footprint can contain more than one area; you could for example, create an area for each area 'style' (Placement Clearance, Body and Model Placement). These could also be different sizes for the same footprint and on different layers if required. You could have the Placement Clearance with plenty of space around the pins and the Body area representing the physical device body at a smaller size for example.

Defining Pads as being Surface Mounted

Where surface mounted pads are used, by default the layer these occupy will be defined as <Through Board>. For surface mount use where they do not have drill holes, these should be assigned to be layer specific, e.g. Top Side or Bottom Side.

Generally, or unless specifically required, SMD pads are defined for the Top Layer, and because mirroring the Component in the design automatically swaps them to the other side. The Pulsonix library items defined as SMD will be placed, by default, on the <Top Side>.

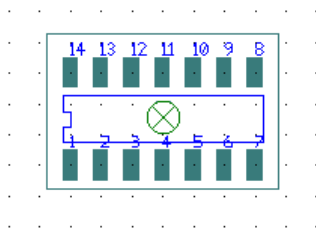

► To change the pad side

1. Add the first pad to the footprint.
2. Assuming that all the pads are the same, you should select the first pad and right click.
3. From the menu select **Change Layer**

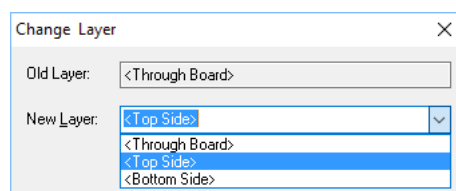

4. From the dialog change <Through Board> to <Top Side> using the **New Layer:** drop down list, and click **OK**.
5. The first pad will now be on the **Top Side**.
6. You may also wish to change the style at this point using the **Change Style** option from the context menu.
7. With the first pad selected, select **Pad** from the **Insert** menu.
8. The style and layer of the first pad will be picked up for pad 2 and any subsequent pad.
9. Insert and place the pads required and then press <Esc> when finished.

Shapes that swap layers when mirrored

Where shapes for layer specific outlines are used, for example a Top layer Silkscreen outline used on a surface mount device, when the Component is mirrored to place it on the opposite side of the board, you will normally also require that as well as the pads swapping sides, the outlines also change sides and are mirrored automatically.

For this you will not need to do anything special to the outlines other than ensure that there is an ‘opposite’ layer available when the Component is read into the design. So, for example, where a Silkscreen Top exists on the Top Side, a Silkscreen Bottom should exist on the Bottom Side.

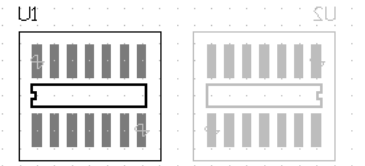

In this example above, U1 is shown on the Top Side and U2 on the Bottom Side but the Pads and Shapes only exist on the ‘outer’ sides having been initially created in the footprint editor on the <Top Side>.

Adding keep-out areas

As well as documentation shapes and electrical copper shapes, you may well wish to add areas that can be used to regulate other Pulsonix processes, processes such as the auto router where it is not allowed to route across the area defined.

For these shapes you should use the **Insert Area** option, any further information is defined through the **Properties** of the area.

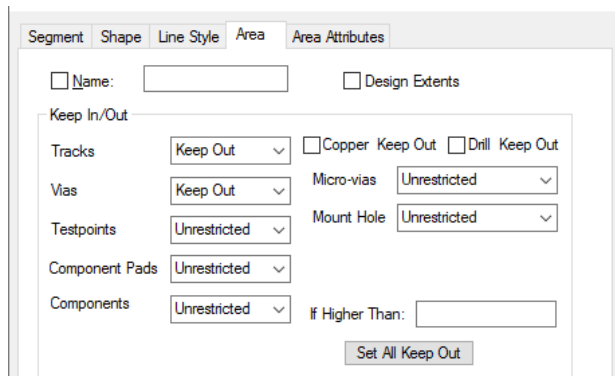

From this dialog you can select that **Tracks**, **Vias** and **Testpoints** are defined as being **Unrestricted** or **Keep-Out** from this footprint area. You cannot assign Keep-In restrictions to areas in the footprint, this only applies in the PCB design itself.

When used in a design, a **Design Rules Check** can be used to verify that where restrictions apply, the rules are observed. This also applies to the **On-line DRC** option.

Copper pour in the Footprint Editor

Copper pour in footprints works slightly differently to that of the main PCB design option. You cannot insert Templates in the footprint but can ‘flood’ areas with copper. To create areas of copper which have cutouts ‘poured’ into them, you must have the **On-line DRC** option switched off otherwise it won’t let you add the Copper over any other electrical items.

Adding the Component Name position

The **Component Name** placeholder is an attribute that has an entry on the **Insert** menu for convenient use. Within the Footprint editor, the Component Name attribute is unsatisfied, this means that until the footprint is used a part of the Part definition in a PCB design, there is no value for the Component Name. The value would be the Component Name itself, e.g. U1, IC1, C2 etc.

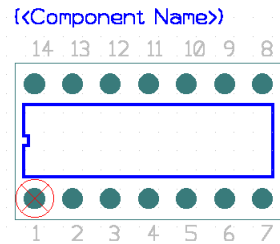

The Component Name placeholder can be placed anywhere on the footprint but it makes sense to put it somewhere representative of its final position. By default the Layer that the name occupies will be a Silkscreen layer.

*Note: The **Component Name** placeholder attribute can also be added to the footprint using the **Insert Attribute Position** option.*

► To add the component name

1. From the **Insert** menu, select **Component Name**.
2. The Component Name placeholder will be dynamic at the end of your cursor ready for placing. Place it on the footprint and click to release.
3. The **Style** and **Layer** can be changed during placement or by selecting it after and using a right click to display the context menu.

Adding Attributes

Multiple instances of the Component Name can be added. This may well be a requirement if you wish to have the Component Name on a copper electrical layer.

This can be simply achieved by adding an additional Component Name attribute and changing its Layer.

Likewise, other system or user defined attribute placeholders or names can be placed on the footprint. You can add the attribute placeholders as a locator for unsatisfied attributes, attributes which have values assigned when used in the PCB design. You can also add attributes with Values into the

footprint. These might be attributes which values are relevant to a specific footprint, the Manufacturer perhaps.

► To add attribute placeholders (position)

1. From the **Insert** menu, select **Attribute Position**.

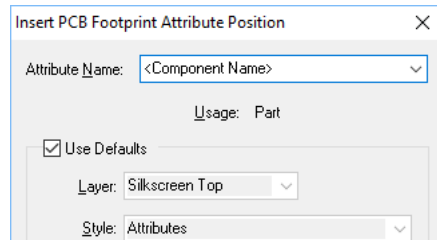

2. Select one of the system attributes (shown in braces i.e. <Date>), or one of the user defined attribute names shown at the bottom of the drop down list.
3. While dynamic on the end of your cursor, right click and select an option from the menu. You can change the **Layer** and **Style** from this menu.

► To add an attribute with values

1. From the **Insert** menu, select **Attribute**

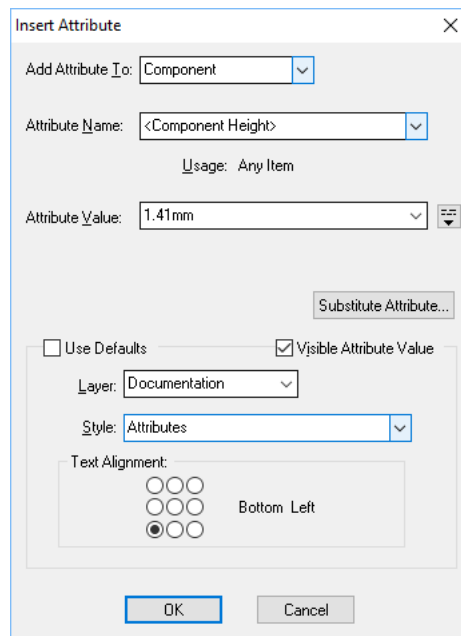

2. From the drop down list select the item to **Add Attribute To**
3. From the drop down list select the **Attribute Name**. If a user-defined name is required it must first exist in the **Technology Attribute Names** list.
4. If a user defined attribute name has been selected, you will now be able to type an **Attribute Value**, if not, only <Placeholder> will be available for an unsatisfied system attribute.

5. Click **OK** to exit the dialog.
6. Place the attribute value that now appears on the end of your cursor. Single Click to release the value.

Associate pads to copper

You can associate pads to copper (or other pads) in the Footprint editor so that DRC errors don't occur.

The pad and copper association is done in the Footprint editor using the **Add To Net** dialog on both the pad and the copper.

► To associate pads to copper

1. Select the pad, this must be done first.
2. Using the context menu option, **Add To Net**, the pad number will be displayed by default, this is the most logical choice for the name but is user defined, click **OK** to add it.

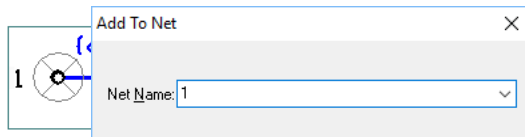

3. Select the copper to be associated and right click.
4. Again, select **Add To Net** from the menu. From the drop down list select the pad number or the relevant name to make the association. If using breakouts on any other pads these will also have net names or pad numbers so you must choose carefully.

Plot/Print footprints

For verification or documentation purposes, you can output the Footprint to a printing or plotting device using the **CAM/Plot** output option from the **Output** menu. This works in the same manner as the CAM/Plot option from within the PCB design editor. Please refer to the previous *Chapter, Outputting For PCB Manufacturing* for more details on using this option.

Footprint Alternatives

The Footprint Editor is only used to create individual footprints that are used by the **Part** definition. If you wish to have a Part with multiple or alternative footprints, you should add these in the Part definition within the **Parts Editor**. See later in this section *Creating Parts*.

Breakouts in the Footprint

The Footprint editor has the ability to create breakout patterns, with or without breakout vias. The method for creating breakouts is the same as if adding a track to the Footprint in the design.

The advantage of creating the breakout with the Footprint is that it only has to be done once. Whenever the Footprint is used it then automatically has these properties. Each Footprint instance for a Component can have the breakouts switched on or off, and they can automatically be converted to tracks.

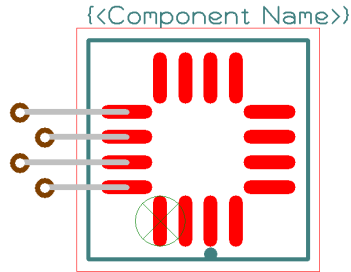

You have some specific design features for creating breakouts: **Insert Breakout**, and once the breakout has been added, **End On Breakout Via**.

In the **Technology** file, breakouts use the **Track Width** and **Via Pad Style** but are in fact breakouts when added to the Footprint.

The breakouts are created on the normal electrical layers but once the Footprint is added to the design these layers act as the 'default' layer for the track once converted.

On the **Options** dialog there is an **Edit Breakout** tab, this is only available in the Footprint editor and is replaced with the equivalent dialog **Edit Track** in the PCB design editor.

Default values for breakouts are taken from the **Design Settings** option, **Defaults** and **Breakout**. The default values define the **Minimum** and **Nominal** breakout widths and the default **Via Style**.

Layer defaults for breakouts are taken from the **Track** defaults.

► To add breakouts to a Footprint

1. Start to create a new Footprint or edit an existing Footprint from the library.
2. Select the **Insert** menu and click on the **Insert Breakout** option, or select the Insert Breakout option from the PCB Footprint toolbar.
3. Draw in the breakout as if add a new track. Use the options from the context menu to change the style and layer etc.
4. Use the options on the context menu to finish the breakout. This can be with no via, with a via or with a Testpoint via.
5. Save the Footprint to the library and include in a Part definition as normal.

Once a Footprint contains a breakout it is saved in the normal way using **Save to Library**. If a breakout pattern needs to be changed, the Footprint can be edited and saved, then reloaded in the design. You cannot edit breakouts directly in the PCB design.

Using **Properties** on a breakout in a Footprint there is a switch you can use to stop it from being automatically converted to a track (**Automatically convert to Track (when pad is on a net)**). The only way to convert a breakout that has this flag cleared to a track is to select it directly in a PCB design and use the context menu **Convert Breakouts to Tracks** option. Selecting the whole component or net and using the same option will not convert it to a track unless its flag is set.

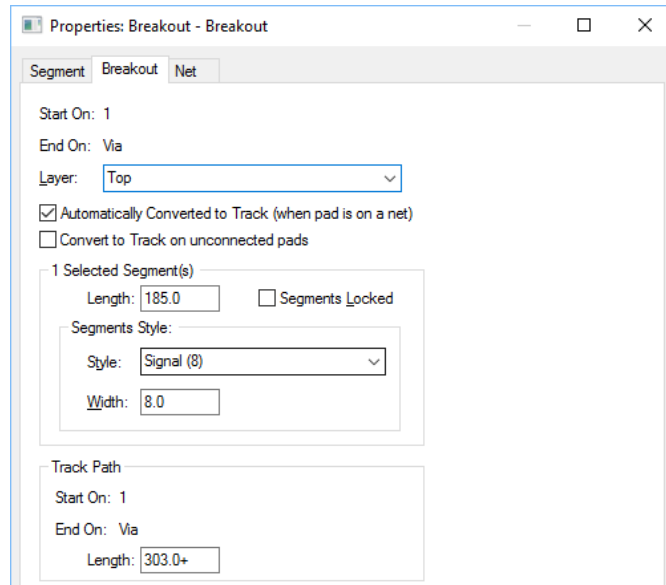

With nothing selected, you must use the context menu option **Convert Breakouts to Tracks**. This is the only way to convert breakouts with the switch mentioned above set on.

Creating Parts

Parts are created using the Parts Editor or the Parts Wizard. The Parts Wizard is an automated and guided process to enable you to create Parts quickly. This is discussed later on in this section.

What are Parts?

Parts or Part definitions are used by both the Schematic and PCB design editors. This definition ties the designs together and provides a common name when transferring from one to another. The basic Part definition itself contains references to a Schematic Symbol and a PCB Footprint or multiple Footprints. The Part can also contain name mappings, Gate & Pin swapping information and attributes to build up a more comprehensive Part definition.

Terminology of a Part Definition

A Part definition contains various items that are used in the creation process. Below is a quick overview of the terminology used:

Gate – One gate or a number of gates make up the internal definition of a Part. A gate references a symbol. A gate and symbol have a 1:1 correspondence. Multiple gates can reference the same symbol. Many Parts will be single gates where there will be one gate and the one symbol.

Symbol – Name reference to the Schematic Symbol to be used in the Part definition. A graphical picture of the Symbol is also shown in the Part editor.

Symbol Pin – This is pin sequence number that you will see when creating or editing the Schematic Symbol.

Pin Name – This is the actual name which appears in the design on the pin/pad and which appears in the netlist. This name can also be alphanumeric, e.g. A43, B43, C43 etc.

Logic Name – A descriptive functional name of the pin, e.g. CLK, RESET etc.

Pin Swap – This defines pin swapping information for use with the manual and automatic pin swapping options.

Gate Swap – This defines gate swapping information for use with the manual and automatic pin swapping options.

Net Name – Defines the name of the net to which this pin is connected in the design automatically when the Part is used. Usually used for power and ground pins.

Pin Type – This defines the electrical function of the pin.

Pin Network – A Pin Network defines one or more components which must be connected to the pin when the part is used in a design.

Footprint Pin – This is pin sequence number that you will see when creating or editing the PCB Footprint.

Part entity correlation

There are two sets of data, that of the Schematic Symbol and the PCB Footprint. These are tied together using the Part definition. This definition pulls together the pins and numbers of the Schematic Symbol to the pads and numbers of the PCB Footprint. The Part definition allows you to map these pins/pad numbers and to rename or renumber them as well. The Pin Names used will tie both sets of pin data together from the Schematic Symbols and the PCB Footprints.

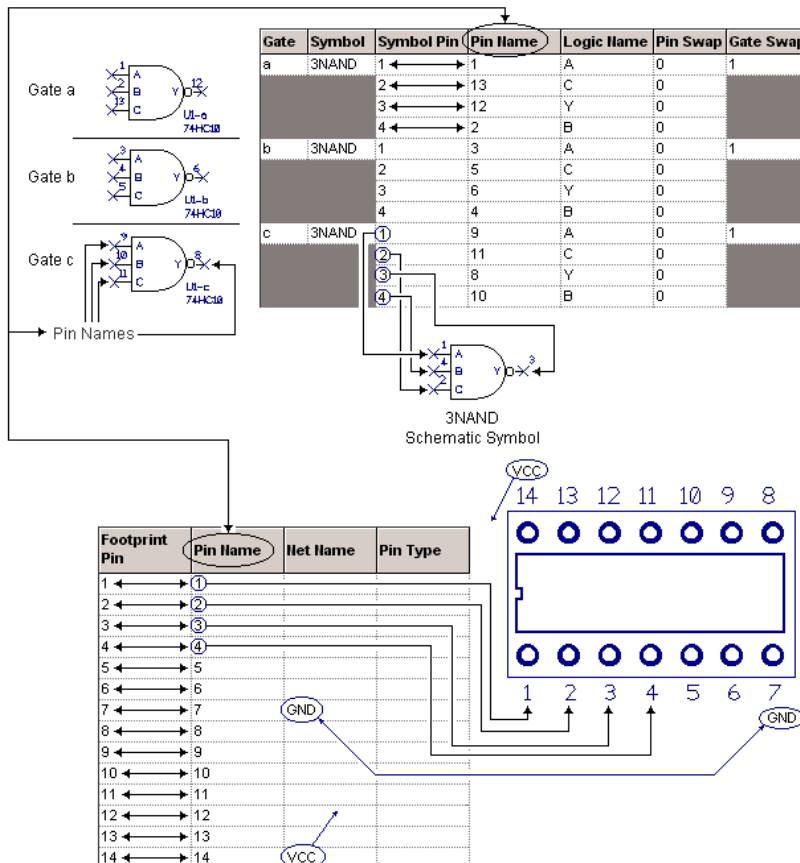

Using Part Technology Files

Part technology files are used in much the same way as other technology files except that because Parts are really only definitions as such, they do not have the depth of use. These files contain predefined Net Names and predefined Attribute Names.

As with other technology files, using a Part technology files allows you to predefine Net and Attribute names which provides consistency across all new or edited Parts. This also enables a quick mechanism of adding these names to the current Part without having to type the name in, you can select the names from a drop down list.

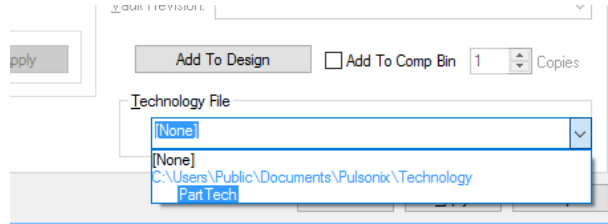

Creating Basic Parts

From the Part editor, you can create Part definitions or editing existing definitions. This is done by selecting a Part library, and clicking the **New** button on the Contents page, or by selecting an existing Part to edit and clicking the **Edit** button. Once the Part editor has opened the functionality is the same.

In our example below, we will use an old-school 7400 device from Ti (SN74x00D). The datasheet would show the Part pin assignments like this:



www.ti.com

5 Pin Configuration and Functions

**SN5400 J, SN54xx00 J and W, SN74x00 D, N, and NS, or
SN74LS00 D, DB, N, and NS Packages
14-Pin CDIP, CFP, SOIC, PDIP, SO, or SSOP
Top View**

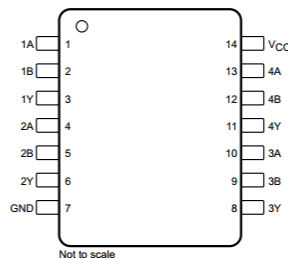

► To create new Parts

1. From the **Parts** tab of the **Library Manager**, click **New** (the button next to the **Contents** window).
2. This will display the **New Part** dialog.

3. This dialog will be blank initially and will require completing.
4. Enter a **Part Name**, this is mandatory.
5. Select the **Part Type** that you wish to create.
6. If you understand how to create Parts, this will be all that it is required to get started.
7. However if you need more help, select the **Provide Part Details Now** check box and fill in the detail. You could also use the **Part Wizard** to guide you through this process.

8. The additional drop down part of this dialog is broken down into 4 separate areas:
9. The **Description**, **Part Family**, **Name Stem** and **Pin Count** selection:

10. The **PCB Footprint** selection:



11. The **Schematic Symbol** selection:

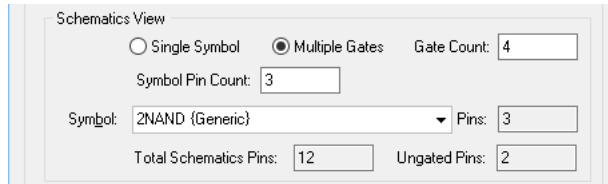

12. The **Power Pins** selection.

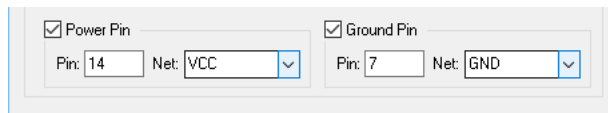

13. With all the additional sections, any of the information can be omitted until later on. You can edit the Part definition in the editor and provide the information as you require.

14. By completing as much of this detail as possible, the program will create as much of the Part as it can. You will also note that on some of the entries, by putting in some of the detail required, Pulsonix will try and assist you by completing the rest based on the initial entry.

15. Click the **OK** button to proceed.

The Parts Editor

The Parts editor allows you to create the Part definition using a series of tab driven dialogs.

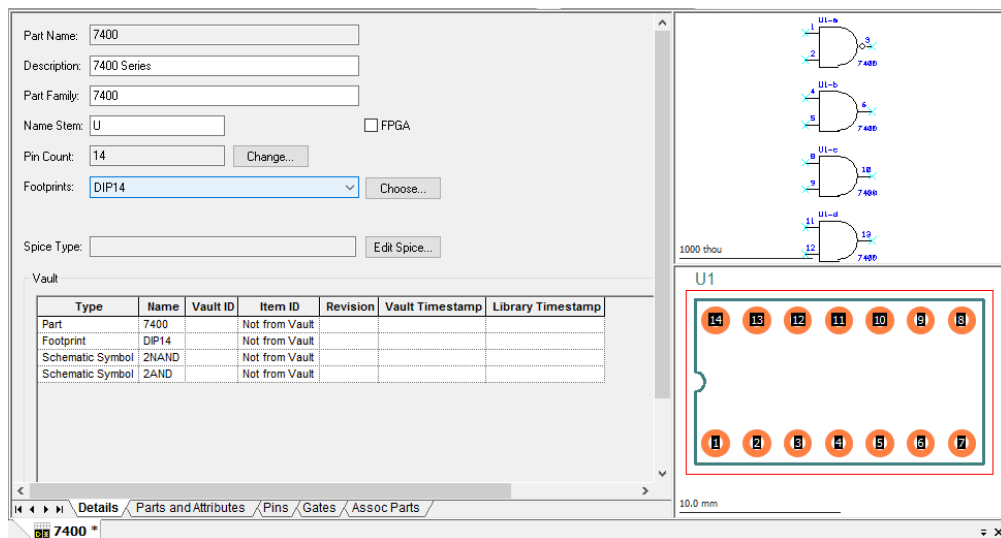

Details Page

The Details page is used to define the high level definition of the Part. This displays information previously entered when creating the Part from new or by editing an existing Part. You can edit and change information here if you wish but it will have an effect on the other pages.

The **Spice Type** entry is for mapping the name of your Part to a Spice device type if the Part is to be used for Spice simulation through the Pulsonix Spice product. For more information about using the Spice Type field, please refer to the reference manual supplied with Pulsonix Spice.

Footprints and alternative Footprints

The footprint order can be changed so that the item displayed in the drop down list is also the default item to be selected when using **Insert Component** in the PCB design editor or when translating from Schematics to PCB.

You also use this entry to define alternative footprints for this Part definition. You may have a Part definition which uses multiple footprints which are selected based on your manufacturing technologies. For example, you may have alternatives for through-hole technology, or surface mount, or SMT but vapour phase or reflow soldered. These can all be accommodated.

► To change or add a Footprint

1. To change the Footprint displayed in the Footprints drop down list box, click on the small box containing the 3 dots next to it. This will display the Footprints dialog:

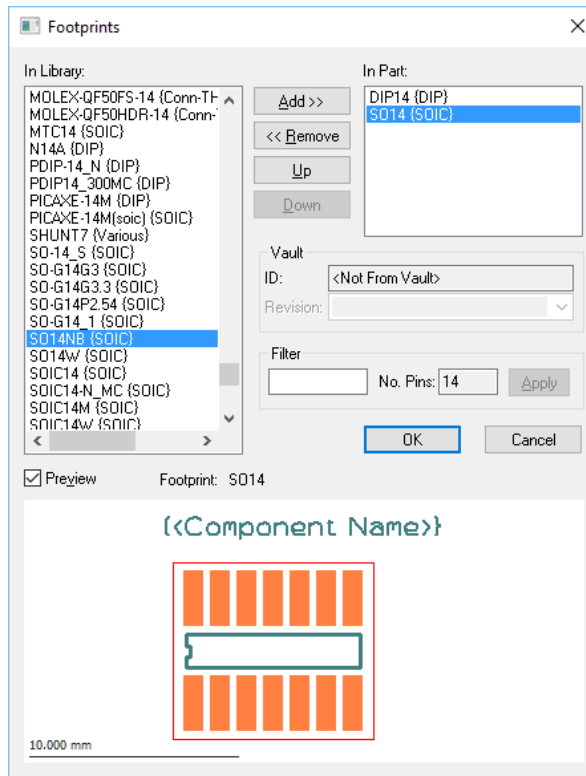

- The Footprints on the right hand side of the dialog are the ones which are available for the Part definition. They all match the number of pins for the Part and are read from the PCB Footprint libraries under your Libraries search path.
- To add a Footprint to the Part definition, you must select it in the left hand list first and click the **Add>>** button. This will promote it to the right hand window.
- Likewise, to remove a Footprint from the list, select it and click the **<<Remove** button. You can also double-click the item to **Add** and **Remove** it from the current list.
- The order is important, the top most Footprint in the **In Parts:** list on the top right hand of the dialog is the one used as the default when using **Insert Component**. To change the default Footprint use the **Up** and **Down** buttons to move the one required to the top of the list. This order is also used when viewing a **Component** in the **Properties** dialog in your design. Each of the Footprints defined in this list will appear as available for this Part definition in the design.

Parts and Attributes Page

The Parts and Attributes page is used to define Part groups and to add individual Part based attributes. Part Attributes are always available on components in the Schematic and PCB designs. Alternatively, you should use the **Part Attribute** editor from the **Library Manager** Parts dialog.

Attributes		
Part Name	Manually Name Parts	1008CS-120XJLC
Attributes	Mfr	Coilcraft
	L	10nH
	Freq	50MHz
	TOL	5%
	Qmin	50@500MHz
	SRFmin	3300MHz
	DCRmax	0.09
	Irms	1000mA
	<Hyperlink>	www.coilcraft.com
	<Component Height>	2.03mm
	Category	Inductor/Coilcraft 1008

► To add or edit Part attributes

- To add or edit **Part Attributes**, select the Part row or cell.
- If the attribute field already exists, with data to change or because it exists in another Part name, click on the field and right click. The following context menu is displayed:

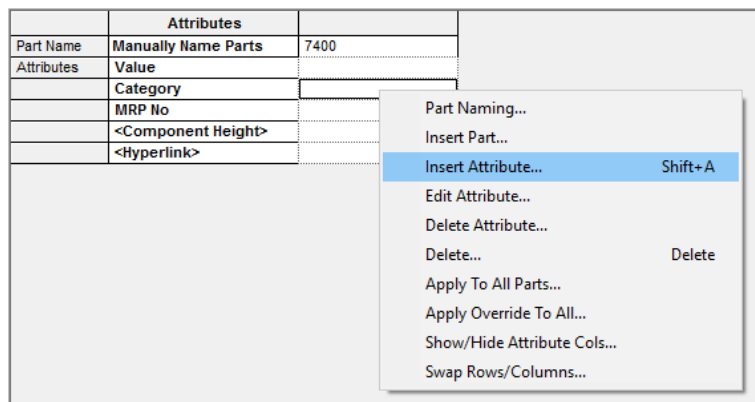

- From the menu, select **Insert Attribute** if you wish to add a new attribute, or **Edit Attribute** if you wish to edit an existing one. All the options on this menu are available from the main menu under **Edit** and **Insert**.

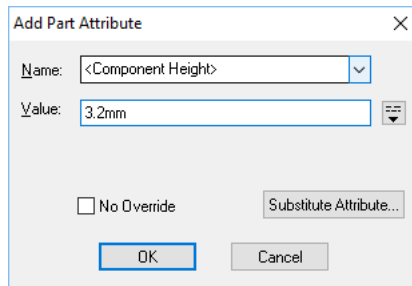

- Click **OK** to accept the new attribute value.

Part Attribute Editor

Within the Parts library there is a facility for editing **Attributes** using the attribute editor. This is available using the Attributes button on the Parts dialog.

By clicking the **Attributes** button you can select all of the library items in the list or the current selection (from the **Contents** list). The **All Library Items In List** radio button will select everything in the contents list, be it the whole library (<All Libraries>), or just a selected library. Care should be taken when <All Libraries> is being used as this may take some time to load into the Attribute Editor.

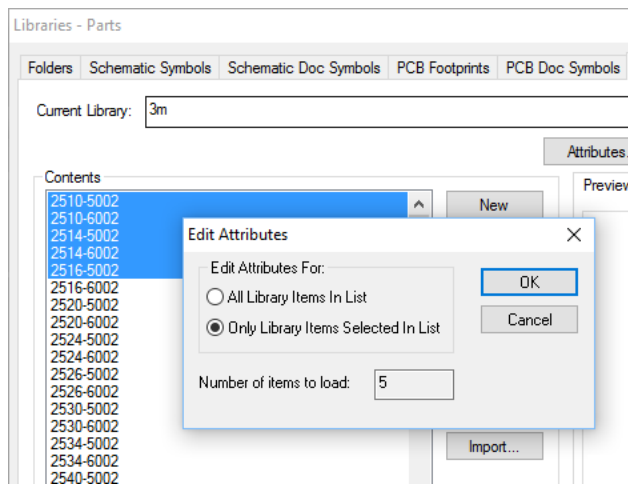

Clicking **OK** will display the Attribute Editor with the Parts Libraries loaded. For Parts you can edit attributes for both Parts and Pins.

Pins Page

The Pins page is used to reference and map PCB **Footprint Pins** to the **Pin Names** displayed in both the Schematic Symbols and PCB Footprints in the relevant design editors.

The **Footprint Pin** name is the actual pad sequence number assigned when the Footprint was created. This list will not include mounting holes added to the Footprint using Insert Mounting Hole. When defined for a Part, this would normally be a 1:1 mapping with the **Pin Name** but can be different if

required. For example, if using alpha-numeric pin names A43, B43 etc. or if creating a Part, such as a Relay, where the pad numbers are specifically renumbered to obtain the correct sequence.

Footprint Pin	Pin Name	Net Name	Pin Type	Pin Network
1	1		Input	<None>
2	2		Input	<None>
3	3		Output	<None>
4	4		Input	<None>
5	5		Input	<None>
6	6		Output	<None>
7	7	GND	Ground	<None>
8	8		Input	<None>
9	9		Input	<None>
10	10		Output	<None>
11	11		Input	<None>
12	12		Input	<None>
13	13		Output	<None>
14	14	VCC	Power	<None>

The **Pin Type** field can be used to define the pin type for each pin. This field is used by the Electrical Rules Checker (ERC) in the Schematic editor.

The page can also contain **Pin Attributes**. These can be added by right mouse clicking on any cell on this page. Use the **Insert Attribute** option from the menu. To display Pin Attributes in the design you must add an attribute name placeholder on the Symbol or Footprint.

Footprint Pin	Pin Name	Net Name	Pin Type	Pin Network	Attributes
					<Pin Package Length>
1	1		Input	<None>	0.50
2	2		Input	<None>	0.50
3	3		Output	<None>	
4	4		Input	<None>	0.50
5	5		Input	<None>	0.50
6	6		Output	<None>	

Predefined Net Names

Net Names are the signal pins used for pre-defined net names such as VCC and GND as used on power pins. These are used mainly for assigning 'implied' signals to components used in the Schematic design editor. This means you can create a Part which has Net Names pre-assigned, and when used in the Schematic or PCB designs, the net with the same name are automatically connected together even though they don't physically show on the design (in PCB they do show as connections if more than one component is added). This is particularly useful for de-cluttering the design of multiple power and ground connections.

► To edit Pin fields

1. To edit any of the pin fields to add or change the values, double-click on the cell and type the value in.
2. You can click the right mouse button to reveal the context menu.

Gates Page

The Gates page is used to add Schematic Symbols to the Part definition and to define the Pin Name order or mapping between the Schematic symbol and the PCB footprint pad numbers. It is using this column that you can also define pins as alphanumeric.

Gate	Symbol	Symbol Pin	Pin Name	Logic Name	Pin Swap	Gate Swap
a	2NAND	1	1	A	1	1
		2	2	B	1	
		3	3	Y	0	
b	2AND	1	4	A	1	1
		2	5	B	1	
		3	6	Y	0	
c	2AND	1	9	A	1	1
		2	10	B	1	
		3	8	Y	0	
d	2AND	1	12	A	1	1
		2	13	B	1	
		3	11	Y	0	

You also use this page to add **Logic Names** and **Gate & Pin** swapping information to the Part definition.

When you first enter this page when creating a new Part definition, the page will be empty, ready for you to add the gates. You would have already defined the number of pads that the Part has by entering a PCB Footprint name. You must now add the corresponding number of gates to the Part for use in the Schematic design.

The empty **Gates** page will start off looking like this:

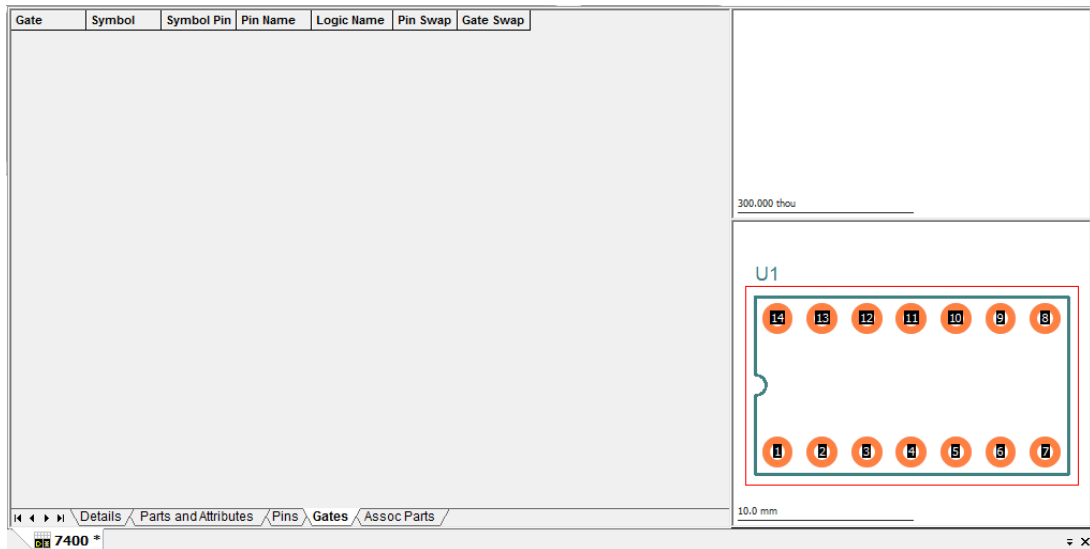

► To add Gates

1. Gates can be added by selecting any one of the cell names, e.g. **Gate** or **Symbol** etc. and right mouse clicking. From the context menu, select **Insert Gate**. This option can also be selected from the main menu under **Insert** or from the **Part** toolbar.
2. You are presented with the following dialog:

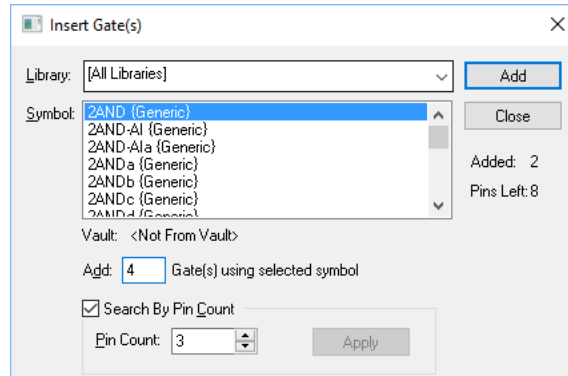

3. From this you can add Schematic Symbols that already exist in the library. The (Schematic Symbol) **Library** list enables you to search the library selected or all the libraries available.
4. Select a Symbol to use from the list. The list can be searched using the **Search By Pin Count** at the bottom of the dialog. You type in the number of pins on the gate and click **Apply** to make the refinement. Only Symbols with a matching number of pins will be displayed in the list.
5. You can also choose the number of Gates to **Add**. If you know there are a number of the same gates to add, use this feature.
6. In the **Add** box, type the number of gates required.
7. Click the **Add** button to add the gates to the Part definition.
8. If more than one Symbol type is required, select the next gate and click Add. Do this until you have defined the number of gates required. Once finished, click the **Close** button. If you make a mistake along the way, click **Cancel** and remove the unwanted gate from the definition and continue. Use the **Delete** option from the context menu to do this or use **Undo**.

Gate	Symbol	Symbol Pin	Pin Name	Logic Name	Pin Swap	Gate Swap
a	2AND	1	1		0	0
		2	2		0	
		3	3		0	
b	2AND	1	4		0	0
		2	5		0	
		3	6		0	
c	2AND	1	8		0	0
		2	9		0	
		3	10		0	
d	2AND	1	11		0	0
		2	12		0	
		3	13		0	

- In its most basic form, the Gates page can now be used with the Part definition.

► **To change or swap Gates**

- Gates can be changed once added. They can be swapped for a different gate Symbol or moved in the Gate order list.
- Select any one of the cells on the Gate you wish to change or move.
- Right click and from the menu select **Change Gate Order** or **Change Symbol**.

Gate	Symbol	Symbol Pin	Pin Name	Logic Name	Pin Swap	Gate Swap
a	2AND	1	1		0	0
b	2AND					0
c	2AND					0

- Change Symbol will display the **Insert Gates** dialog as before. Selecting the **Change Gate Order** option will display a dialog:

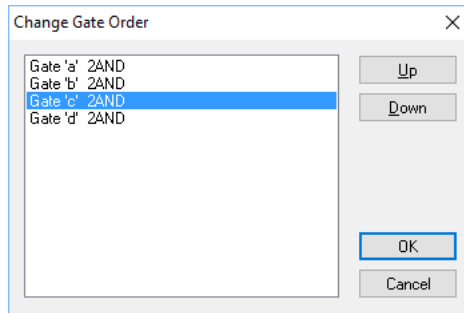

- From this dialog you can select any gate and move its order using the **Up** and **Down** buttons. When you are satisfied with the new order, click **OK**.

Adding Alternative Symbols

Like PCB footprints, you can add alternative Schematic Gates to the Part as well to represent different symbols, for example, box or ‘Z’ shaped resistors or DeMorgan equivalents.

► **To add symbol alternatives**

- Using the **Gates** page, right click and select **Change Symbol** from the context menu.

Gate	Symbol	Symbol Pin	Pin Name	Logic Name	Pin Swap	Gate Swap
a	2AND	1	1		0	0
b	2AND					0
c	2AND					0

- Alternatively, in the **Symbol** cell, select in the cell and off the drop down menu, select **Change Symbol**.

Gate	Symbol	Sym
a	2AND	1
	2AND	2
	Change Symbol	3
b	2AND	1
		2

- From the dialog, select the alternative symbol required from the **In Library:** list.
- Click the **Add>>** button to promote it to the **In Gate:** list.

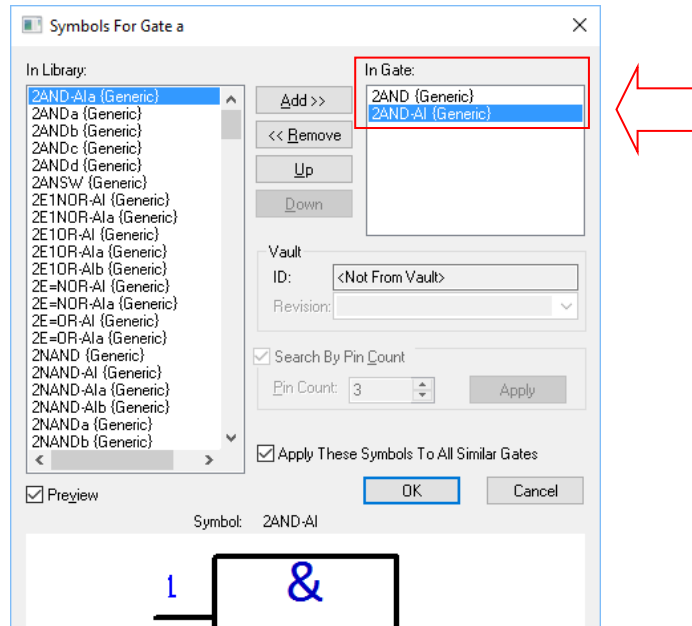

- Click the **OK** button.
- When the **Symbol** list is now dropped down, it will reveal the alternative symbol selected.

Gate	Symbol	Syr
a	2AND	1
	2AND	2
	2AND-AI	3
b	Change Symbol	1
		2

- Save the Part as normal using the **File** menu and **Save To Library**.
- When using this Part in a Schematic design, use the **Next Symbol** option from the context menu to swap to the alternative symbol.
- The **Properties** dialog and **Gates** page will also allow you to change the gate to the alternative using the **Symbol** drop down list.

► To add Logic Names and Gate & Pin swapping information

- You can add Logic Names and Gate & Pin swapping information to this page by editing the relevant cell.
- Double-click on the cell to edit it.

Note: Logic Names, if used, will require the Logic Name attribute placeholder to be added to the Symbol Pin if you wish to display this name when the Component (the Part instance) is used in the design.

Adding Gate & Pin swapping information

The Gate & Pin swapping information is used by both the manual and automatic Gate & Pin swapping options within Pulsonix.

The general rules are: Pins within the same gate with the same Swap Group are considered to be swappable, as are gates with the same Swap Group. A pin or gate with Swap Group set to zero is not swappable.

The Swapping rules

The following rules restrict the swapping of Component gates:

- A gate can only be swapped if all pins have no routes attached.
- The two gates must be on components of the same Part.
- The two gates must be in the same swap group in the Part data.

The following rules restrict the swapping of a Component pin:

- A pin can only be swapped if it does not have any routes attached.

The following rules apply when using the normal swap mode:

- The two pins must be on the same Component.
- The two pins must be on the same gate within the Part data.
- The two pins must be in the same swap group in the Part data.

Numbers used for swapping

When defining Gate and Pin swapping information, the following applies:

- A '0' (zero) means that the pin or gate is not swappable with items of that same group or gate (the numbers used for pins and gates are different). A blank entry also has the same effect.
- A '1' means that the pins or gates in that group are swappable with anything of the same number.
- A '2' means that the pins or gates in that group are swappable with anything of the same number. The same would apply for any number used which matches another number of the same swap group.

In the example Gates page shown below, the input pins have been set to pin swap group 1 to allow swapping between them in each gate. Also, the gates have been set to gate swap group 1 to allow each gate to be swapped both internally within a component and externally between different components using this part.

Symbol	Symbol Pin	Pin Name	Logic Name	Pin Swap	Gate Swap
2AND	1	1	A	1	1
	2	2	B	1	
	3	3	Y	0	
2AND	1	4	A	1	1
	2	5	B	1	
	3	6	Y	0	
2AND	1	9	A	1	1
	2	10	B	1	
	3	8	Y	0	
2AND	1	12	A	1	1
	2	13	B	1	
	3	11	Y	0	

The diagram below shows how these swap groups would apply to the actual pins on the symbols.

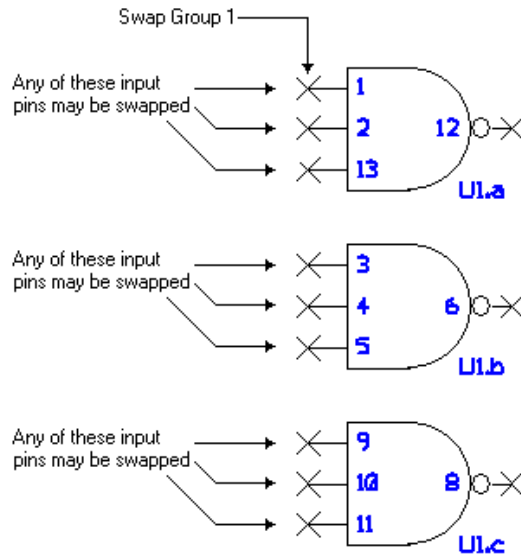

Pin Names

The Pin Names can be changed in the Pin Names column to map the sequence of pin names used on the schematic to that of the actual PCB footprint. These names can also be alphanumeric as you would require for BGA devices for example (although the naming is carried out on the **Pins** page not the **Gates** page).

Pulsonix - [Part: C:\Users\Public\Documents\Pulsonix\MasterLibraries\PowerPC.pal: MPC603E]

File Edit View Insert Setup Tools Window Help

Gate	Symbol	Symbol Pin	Pin Name	Logic Name	Pin Swap	Gate Swap
a	MPLIB_PPC1	1	D08	__CKSTP_IN	0	0
		2	D11	L1_TSTCLK	0	
		3	D12	L2_TSTCLK	0	
		4	B10	LSSD_MODE	0	
		5	A08	PLL_CFG0	0	
		6	B09	PLL_CFG1	0	
		7	A09	PLL_CFG2	0	
		8	D09	PLL_CFG3	0	
		9	C09	SYSCCLK	0	
		10	C02	TBEN	0	
		11	L02	__AACK	0	
		12	L01	__BG	0	
		13	G16	__DRTRY	0	
		14	A07	__HRESET	0	
		15	B15	__INT	0	
		16	C13	__MCP	0	
		17	D03	__QACK	0	
		18	A16	__SMI	0	
		19	B14	__SRESET	0	
		20	H14	__TA	0	
		21	H13	__TEA	0	
		22	C04	__TLBISYNC	0	
		23	C10	__TRST	0	
		24	C11	TCK	0	
		25	A11	TDI	0	
		26	A12	TDO	0	
		27	B11	TMS	0	
		28	H15	__DBDIS	0	
		29	N01	__DBG	0	
		30	G04	__DBWO	0	
		31	D07	CLK OUT	0	

► **To Change the Pin Names order**

1. To use a different number to the default sequence, you must select the cell which is to be different. You may do this on the **Gates** page of the Parts Editor.
2. Selecting it once will reveal the small ‘down’ arrow to the right side of the cell.
3. Selecting the arrow will display the drop down list of all the pin names for that gate.
4. Select the pin name required.

Symbol	Symbol Pin	Pin Name	Logic Name	Pin Swap	Gate Swap
2AND	1	1	A	1	1
	2	1	B	1	
	3	2	Y	0	
2AND	1	3	A	1	1
	2	4	B	1	
	3	5	Y	0	
2AND	1	6	A	1	1
	2	7	B	1	
	3	8	Y	0	
2AND	1	9	A	1	1
	2	10	B	1	
	3	11	Y	0	
2AND	1	12	A	1	1
	2	13	B	1	
	3	14	Y	0	

5. The cell will update with the new name.

► **To make the Pin Names alphanumeric**

1. If you wish to make Pin Names alphanumeric, you must do this on the **Pins** page of the Parts Editor.
2. Select the cell which is to be the first name in the sequence. For example A1 or B1 if the sequence is to be A1, A2, A3 etc. or B1, B2, B3 etc.
3. type the name required, i.e. A1
4. Select the range of cells on which the Pin Names are to be renamed.
5. Right click and from the context menu, select the **Apply Increment to Selected Cells** option.

Footprint Pin	Pin Name	Net Name	Pin Type	Pin Network	Attributes <Pin Packa
1	A1		Input	<None>	0.50
2	2		Input	<None>	0.50
3	3		Output	<None>	
4					
5	5				
6	6				
7	7				
8	8				
9	9				
10	10				
11	11		Input	<None>	0.50

Insert Attribute... Shift+A

Copy... Ctrl+C

Paste... Ctrl+V

Name Pins by Row/Col...

Apply Increment to Selected Cells...

6. The selected cells will now be numbered sequentially based on the name of the first cell.

Footprint Pin	Pin Name	Net Name	Pin Type
1	A1		Input
2	A2		Input
3	A3		Output
4	A4		Input
5	A5		Input
6	A6		Output
7	7	GND	Ground
8	8		Input

Mapping Multiple PCB Pads to same Schematic pin

You can map one Schematic pin to many PCB pins using the Part Editor.

This feature allows you to model certain types of Component that have 'internal' connections within the Component itself, or those that have multiple pins that need to be assigned to the same net. This is an alternative method to connecting pads together in the footprint by adding to the same net or using wires. The advantage of this method is that it means the footprint definition can remain neutral and generic, where the Part definition is made specific to a device.

These mappings are made in the **Part Editor**. You will need to edit the Part that requires this mapping. On the **Gates** page, right click on the appropriate **Pin Name** cell and then select **Map Multiple Pcb Pins** from the context menu. This will turn the cell into an edit box instead of a drop down list to enable you to enter a list of PCB pin numbers. Type the Pin Numbers required into the list.

Gate	Symbol	Symbol Pin	Pin Name	Logic Name	Pin Swap	Gate Swap
a	TR5	1	1	D	0	0
		2	4	S	0	
		3	3	G	0	

When edited, the Pin Name cell may look something like this for example:

Gate	Symbol	Symbol Pin	Pin Name	Logic Name	Pin Swap	Gate Swap
a	TR5	1	1,2,5,6	D	0	0
		2	4	S	0	
		3	3	G	0	

Pin Name format

The list can be separated in two ways depending on how you want them to behave in the PCB:

- Use of a comma ,
- Use of a plus + sign
- Separated with commas (to assign all the PCB pads to the same net, with connections in the PCB that should be routed). When this Component is used in the PCB design, all the pads are shown connected with visible connections and should be routed to ensure completion:

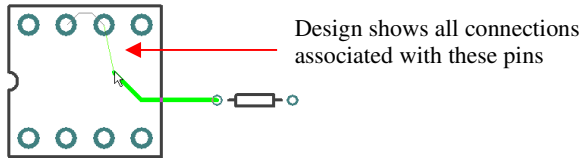

- Separated with plus signs (to assign them to the same net, but indicating the pins are connected internally within the component and do not all need to be routed). When used in the PCB design, routing close to an 'associated' pin will optimise to that net indicating a legal routing target.

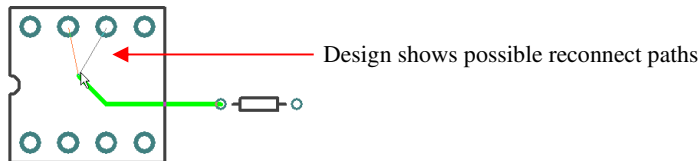

Associated Parts

Where Parts are defined in the Parts libraries, you may also include additional Parts that although are added to the manufactured PCB, do not appear on the Schematic or PCB design as electrical items. For example, a transistor which when built must have a heatsink, a thermal washer, a nut and bolt and a plastic washer. The design may also contain Associated Parts which must be ordered as part of the Bill of Materials but which aren't electrical items, for example mounting columns and plastic insulation washers and nuts.

These Parts are called Associated Parts and can be of Schematic or PCB or both usages. All Associated Parts can then be extracted using the Report Maker facility.

Where Associated Parts are 'Footprint' specific, for example in the case of some transistors where there may be up to four different mountings, and hence four different associated Part variants, these Associated Parts can be defined with the Footprint itself. This uses exactly the same mechanism as the Design level Associated Parts using the **Design Properties** dialog.

Associated Parts

From within the Parts Editor dialog you can associate Parts using the Associate Parts dialog. This will provide you with a list of all the additional Parts which will be called whenever the main Part is used in the design.

By right clicking in this dialog you are presented with the **Add Associated Parts** option on:

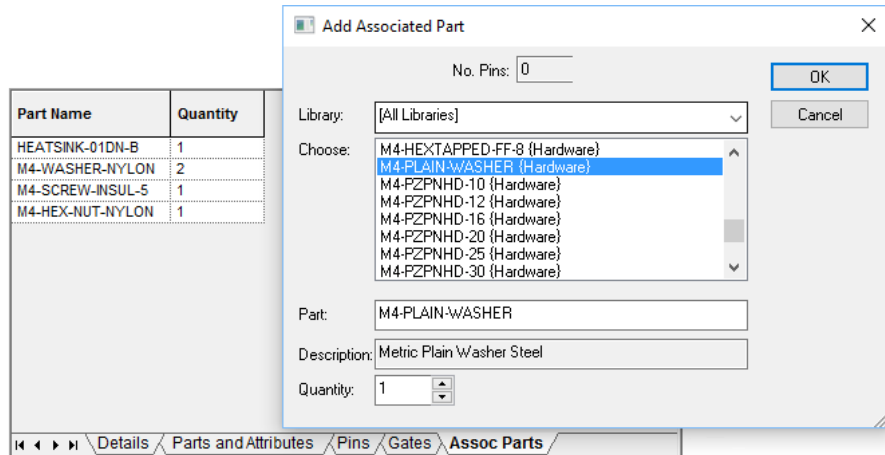

You can use the **Add Associated Part** dialog by either typing in the **Part Name** into the **Part** entry box or by selecting from the list presented in the **Choose** box. The Choose box will list all Parts in the Parts library that have been defined with no pins. If the Part has pins then you must type in its name to use it.

The **Quantity** of each associated Part can also be defined so more than one Part can be used for each main Part.

The associate Parts for a Part definition might then look like this:

Part Name	Quantity
HEATSINK-01DN-B	1
M2.5-SPRING-WASHER	1
M2.5-HEX-FULLNUT	1
M2-HEX-NUT-NYLON	2

The Part is then saved.

Each time this Part is used in the design it will also include an instance(s) of all the associated Parts. The full list of Associated Parts for the design can be viewed at any time by using the **Design Properties** option from the **Edit** menu.

Design Level Associated Parts

Quantities can be changed on a design basis using the **Design Properties** dialog. This dialog displays a list of all the Part based Parts Associated, and design based Associated Parts which have been added to the design.

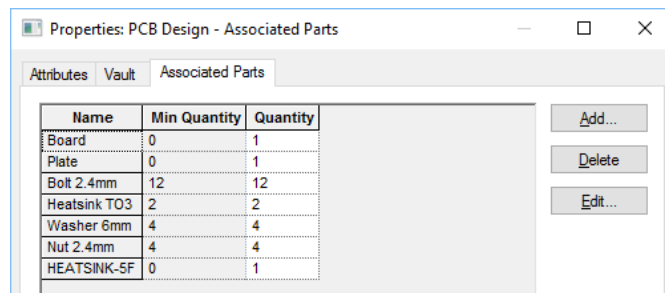

In the above example, all items except the *Bolt 4mm* Part have been added as Part based Associated Parts. The *Bolt 4mm* has been added through this dialog as a board (or design) Associated Part.

The Associated Parts list shows the name of the Part, the minimum number of instances (which are associated with components in the design), and the total number that includes any additional instances that have been defined through this dialog. You cannot have less than the minimum number.

The **Add** button allows you to add an associated part to the design. This displays the **Edit Associated Part** dialog.

To edit an existing Associated Part, select the appropriate row in the grid and press **Edit**. This displays the **Edit Associated Part** dialog, with the data from the current row pre-selected. You can also change the quantity directly in the grid.

Use the **Delete** button to delete the selected row. You can only delete Associated Parts that have a minimum quantity of 0.

Creating Unusual Parts

All Parts are created using the New Part dialog connectors use the special Connector check box as discussed previously. There are some Parts that need a mention because they use a slightly unusual configuration.

Creating Relay Parts

Relays typically require a limited number of pads but then for the numbers to be to artificially sequenced as though the additional pads exist.

As the picture below shows, a 4 pin relay would have 4 pads placed, and sequenced 1 – 4 as expected.

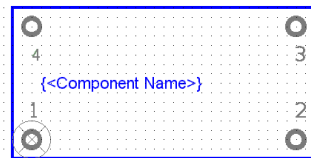

However, the relay fits into a socket that has 14 pins, so the pin numbers displayed need to show a new sequence. This is achieved using the **Pins** page and by editing the **Pin Numbers** to show the required pin sequence. This is shown below and includes the new pin numbers on the displayed Footprint and Symbol.

Gate	Symbol	Symbol Pin	Pin Name	Logic Name	Pin Swap	Gate Swap
a	Relay Switch b	1	1		0	0
		2	14		0	
		3	7		0	
		4	8		0	

⏪ ⏩ Details / Parts and Attributes / Pins / Gates / Assoc Parts

Documentation Symbols

Documentation Symbols are created in much the same way as Schematic Symbols and PCB Footprints using their own respective Symbol editors.

Doc Symbols differ from normal symbols in that they do not appear in any Parts list, and in the case of Schematic Symbols, are not translated to the PCB design.

Creation of specific Documentation Symbols has been covered previously in the Schematic and PCB design editors.

Pulsonix Database Connection (PDC)

Pulsonix supports an advanced ODBC connection structure to external databases through the optional PDC product. This product is fully described in the *Pulsonix Database Connection Users Guide* available as a PDF file and installed with Pulsonix., it is available under the Help menu and Online Manuals> and also in the Online help.

Pulsonix Vault

As well as the standard library mechanism, Pulsonix also has a Vault system. This provides you with a controlled system for saving libraries (as well as designs and technology files). Any editing, saving etc. is booked through the Vault so that a full audit is available as to when and who made changes. The physical changes are also recorded. This option is fully described in the *Vault Users Guide* available as a PDF file and installed with Pulsonix, it is available under the Help menu and Online Manuals> and also in the Online help.

Index

.

.plx format files, 424

3

3DConnexion spaceMouse, 43

4

45 angled routing mode, 266

45 fillet routing mode, 266

A

Absolute coordinates, 19, 87

Active PDF files, 201

Adjust text to readable orientation, 60

Adjust to readable orientation, 70

Admin tools

 vault, 114

Advanced format scripts, 407

Allowed drill sizes, 367

Alphanumeric pins, 459, 466

Apply via, 301

Arc mode, 289

Areas, 285, 295, 444

 area height, 296

 board cutout, 299

 body, 296, 444

 keep in/out, 446

 keep in/out checks, 324

 placement, 444

 placement clearance, 444

Associated parts, 468

Assembly variants, 332

Attached callouts, 318

Attached dimensions, 314

Attributes

 attribute editor, 41

 component name, 103

 design, 106

 drag & drop, 53

 dynamic, 108

 editing, 109

 footprint attributes, 107

 names, 102

 overview, 102

 part attributes, 106

 part editor, 458

 PCB, 321

 position, 103

 printing, 110

 properties, 106

 schematics, 189

 spice type, 456

 user defined, 103

 validation, 110

 values, 102

 variants, 339

Auto Dim, 283

Auto generate plots, 354

Auto select mode, 48

Autorouter, 13

Autorouting, 351

Avoid same net, 220, 304

B

Backup copies, 79

Backups, 76

Barred text, 71

Bilateral dimensions, 316

Bill of material (BOM), 399

Block ports, 151, 153, 177

Block symbol, 151, 154

Blocks, 153, 168

Board

 cutout areas, 298

 outline, 233

 plotting outline, 370

 profiles, 233

Body area, 444

Body height, 296, 445

Branch point, 151, 154

Break silkscreen, 369, 372, 384

Break silkscreen text, 369, 372, 384

Breakouts, 281

 creating, 449

 hide, 281

 plotting, 283

 show, 281

 using, 281

Bus

 bus pins, 170

 bus reference, 151, 155, 163

 closed, 162

 insert, 163

 names in PCB, 167

 nets, 163

 open, 162

 overview, 161

 terminals, 162

C

- Calibrate actual screen width, 44
- Callouts, 317
- CAM Plot, 354
 - auto generate, 354
 - CAM plots dialog, 357
 - check plots, 393
 - combining plots, 390
 - exclude items, 364
 - folder, 76
 - overview, 355
 - plot groups, 360
 - plot preview, 356
 - plot settings, 365
 - schematics, 195
 - slotted pads, 210
 - step and repeat, 358
 - variants, 342
- Can have associated layers, 346
- Case sensitive pin names, 70
- Change grid, 85
- Check plots, 393
- Checking validation strings, 110
- Checks
 - design rules checking, 245
 - Netlist (synchronise designs), 326
- Class to class rules, 218
- Colour files bar, 41
- Colours, 97
 - dimensions, 315
 - load colours, 98
 - schematics, 120
 - selection flags, 49
- Combining schematic pages/designs, 185
- Combining SCM and PCB PDF plots, 203
- Complete as track, 271
- Component bin, 25
 - PCB, 240
 - schematics, 122
 - using, 26
- Components
 - areas, 444
 - body, 296
 - component to component spacing, 218
 - creating, 451
 - definition, 423
 - embedded, 346
 - grid, 85
 - lock/unlock, 253
 - name position, 447
 - next in sequence, 126
 - positioning PCB, 237
 - positioning schematics, 126
 - pushing, 251
 - replacing, 238
 - spans, 346
 - using, 123
 - variant editor, 345
 - variants, 339
- Composite layer spans, 348
- Composite micro-vias, 348
- Composite plots, 380
- Configuring parts browser, 28
- Connections
 - adding danglers, 135
 - bus, 138
 - changing grid, 139
 - changing style schematics, 133
 - inserting, 132
 - PCB, 255
 - power & ground symbols, 160
 - schematic, 131
 - schematics options, 132
 - splitting nets PCB, 259
 - splitting schematics, 140
 - styles, 211
- Connectors
 - using in PCB, 128
 - using in schematics, 128
- Context menus, 49
- Convert breakouts to tracks, 281
- Coordinates
 - absolute, 19, 87
 - display, 18
 - relative, 19, 87
 - system origin, 86
- Copper, 299
- Copper healing, 308
- Copper pour rules, 302
- Copy, 62
- Copying shapes, 293
- Corners
 - 45 degree, 72
 - curved, 72
- Create PCB Group from SCM block, 65
- Creating
 - board outlines, 230
 - doc symbols, 471
 - parts, 451
 - PCB footprints, 439
 - schematic symbols, 430
- Cross hatch, 214
- Cross probing designs, 329
- Cross sheet signal references, 158, 160
- Ctrl-delete, 66
- Current grid, 84
- Customising Pulsonix, 20
- Cut, 62

Cut block, 179
Cutouts, 284, 297
Cyclic backups, 79
Cyclic picking, 48

D

Dark mode, 20
Dashed line styles, 288
Database connection, 471
 variants, 341
Decoupling capacitors, 127
Defaults
 PCB, 208
 schematic, 117
Define pad shape, 212
Defining track sizes in Schematics, 144
Delete, 65
 extended, 66
 pages, 184
 remove from net, 66
 tracks, 66
 unextended, 66
 unrouting tracks, 66
Design area size, 86
Design backups, 76
Design browser, 29, 184
 hierarchy, 169
Design origin, 86, 235
Design properties, 86, 470
 variants, 340
Design rules
 checking, 245, 322
 setup, 217
Design security copies, 76
DFM/DFT rules, 220
Differential pair chains, 92
Differential pairs, 91
Dimensions, 311, 313
 attached, 314
 bilateral, 316
 colours, 315
 tolerances, 315
 unattached, 315
 unilateral, 316
Disconnect end track, 277
Doc shape variants, 341
Doc symbols, 152, 471
 libraries, 423
 schematics, 151
 types, 151
Dockable windows, 25
Documentation symbols, 155
Dongle, 14
Dotted line style, 288

Drag & drop attributes, 53
Drawing profiles, 100
DRC, 245, 322
 error markers, 324
 errors browser, 30, 325
 in footprint editor, 325
 report, 324
Drill drawings, 385
 layer, 389
Drill ids, 367
Drill sizes, 387
Drill symbols, 367, 387
Drill table, 387
Drilling micro-vias, 351
Duplicate, 62
DXF export, 396
DXF import PCB/schematics, 416
Dynamic copper pour, 308
Dynamic optimise, 250
Dynamic properties, 37

E

ECO back to the Schematic, 327
Edit segment, 291
Editing tracks, 263
Electrical rules checking, 147, 459
ERC, 146, 459
 errors browser, 30, 150
Essential for manufacture, 225
Excellon, 384
Export DXF, 396
Export IDF, 396
Export STEP, 396
Exporting netlists, 191
Exporting separate SCM PDF files, 203
Exporting Spice netlists, 192
Exporting SVG format, 396
Exporting ZIP format, 397

F

Facing side, 346
Fanout patterns, 281
Fiducial markers, 393
Files, 78
Filletts, 72
Find, 33
 filter, 35
Finish markers, 269
Fit design, 86
Flip, 57
Flip dynamic, 273
Folders, 75
 libraries, 425
 search order, 77
Fonts, 67

Footprint areas, 296
Footprint attributes, 107
Footprint editor, 440
Footprint libraries, 423
Footprint variants, 338
Force vector, 250
Format scripts, 401
Frame in, 44
Frame select, 46
Free angle adjoining segs, 251
Free angled routing mode, 265
Full back annotation, 327

G

Gate
 name, 123
 parts gates page, 459
 separator character, 123
Gate & pin swapping, 260, 464
Generate reports, 399
Gerber
 import, 416
 intelligent import, 416
 plots, 370
Global Nets, 143
Grid, 82
 component, 85
 component PCB, 253
 crosses, 85
 displayed, 85
 dots, 85
 lines, 85
 no grid, 85
 setting up, 84
 snapping, 84
 steps, 84
 testpoint, 85
 track, 85, 275
 via, 85
 working, 85
 Xcrosses, 85

Groups, 64
Growing shapes, 63, 293

H

Hardware requirements, 13
HASP key, 14
Hatch style
 naming, 214
 style, 214
Hide breakouts, 281
Hierarchy, 168
 block pin types, 176
 block shapes, 181
 blocks, 168

 bus pins, 170
 cut block, 179
 folders, 173
 instances, 171
 overview, 168
 pin types, 177
 pop, 169
 push, 169
 top down design, 173
 updating block instances, 184

Hot fixes, 15

I

IDF export, 396
Impedance rules, 226
Implied junctions on pins, 139
Importing
 CAE netlists, 414
 designs, 413
 DXF files, 231, 416
 ECOs, 327
 gerber files, 416
 IDF, 417
 overview, 413
 spacing rules using csv file, 219
 STEP files, 231, 417

Insert

 area, 295
 attribute, 104
 attribute position, 105, 448
 block ports, 174
 board, 230
 bus, 163
 component from vault, 114
 component name, 447
 component PCB, 235
 component schematics, 123
 connection PCB, 256
 connection schematics, 132
 connector pins, 128
 copper, 299, 300
 cross page links, 157
 cutout, 298
 dimensions, 313
 mounting holes, 233
 mounting holes, 443
 pad, 441
 page, 184
 pin, 435
 profile PCB, 234
 shape, 287
 shapes schematics, 188
 Teardrops, 310
 template, 305

- terminal, 435
- testpoint schematics, 187
- text, 67
- via, 301, 349
- Inspector bar, 37
- Installation, 14
- Intelligent gerber import, 416
- Interaction overview, 55
- Interactive high speed design, 351
- Interface, 18
- IPC naming set, 215
- IPC-2581 Export, 353
- IPC-2581 layer stackup, 226
- IPC-356 Export, 353
- Isolate from plane, 378
- Isolated pads, 307
- Isolation gap, 222
- J**
- JTAG File Export, 353
- K**
- Keep in/out areas, 446
- Keep in/out checks, 324
- Keyboard commands, 23
- Keys Report, 24
- L**
- Latch mode, 49
- Layer class, 368
- Layer class variants, 336
- Layer spans, 347
 - composite, 349
- Layers, 222
 - browser, 31
 - drill drawing, 389
 - layer classes, 224
 - materials, 225
 - spans, 346
- Library
 - .plx format files, 424
 - additional library content, 424
 - conventions used, 424
 - default supplied, 423
 - library management
 - overview, 422
 - manager, 427
 - master library, 423
 - user library, 423
- Light interface mode, 20
- Line select, 47
- Line styles, 211, 288
 - PCB, 292
 - schematics, 119
- Load profile, 100

- Load technology, 98
- Local nets, 143
- Lock, 61
 - components, 253
 - locking errors, 325
 - tracks, 62, 276
 - vias, 62
- Logic names, 463
- M**
- Managing PCB nets, 257
- Manual routing, 263
- Manufacturing
 - checks, 324
 - outputs, 353
- Match net class level rules, 218
- Materials, 225
- Measure tool, 319
- Menu options, 17
- Merge shapes, 297
- Message window, 18
- Micro-vias, 346
 - drilling, 351
 - facing side, 346
 - normal, 347
- Minimum island size, 303
- Mirror, 57
 - components, 58
 - shape, 58
 - shapes, 290
 - tracks, 58
- Mitres, 72
 - default size, 73
 - orthogonal, 73
- Model placement, 296
 - area, 445
- Mounting holes, 152, 155, 232, 443
- Mouse
 - buttons, 43
 - dragging, 45
 - operation, 43
- Move to bin, 241
- Moving items, 55
- Multiple instances, 172
- Multiple PCB pad mapping, 467
- N**
- Name
 - component, 124
 - logic, 459
 - nets, 143, 257
 - pad, 459
 - part, 124
- Naming
 - basic set, 215

- IPC set, 215
 - styles, 215
- NC drill output, 384
- Negative plots, 363
- Net classes, 91
- Net labels, 152, 156
- Net styles, 92, 145
 - composite vias, 349
 - micro-vias, 349
- Nets, 91
 - checks, 324
 - global, 143
 - local, 143
 - names, 211
 - naming/renaming, 143
 - net styles, 91
 - net type, 92
 - optimising PCB, 260
 - rename, 143
- Network licensing, 15
- New
 - PCB design, 205
 - PCB footprint, 439
 - schematic design, 115
- No Grid, 85
- O**
- ODB++ output, 395
- On grid checks, 324
- On-line DRC, 273
 - display clearances, 274
 - Electrical rules checks (ERC), 146
 - options, 245
- Only plot items, 363
- Optimal
 - position, 250
 - rotation, 250
- Optimise
 - connections, 250
 - nets, 260
- Options
 - defaults PCB, 208
 - design PCB, 208
 - track defaults PCB, 270
- Origins
 - absolute, 87
 - relative, 87
 - system, 86
- Orthogonal routing
 - curved, 266
 - fillet, 265
 - mitre, 265
 - orthogonal mode, 265
- Outputting netlists
 - from schematics, 191
- Outputting separate SCM PDF files, 203
- P**
- Pad style naming settings, 216
- Pads
 - defaults, 441
 - layers, 445
 - mounting holes, 443
 - name, 459
 - numbers, 441
 - pad style naming rules, 209
 - reassignments, 442
 - renumbering, 442
 - slotted, 210
 - styles, 209
- Page border
 - schematics, 121
- Page links, 152, 156
- Pan, 43, 44
- Part attribute editor, 458
- Part attributes, 106, 457
- Part variants, 332, 338
- Parts
 - associated, 468
 - browser, 27
 - creation, 451
 - libraries, 423
 - reloading, 130
- Paste, 62
- Pasting in schematics, 185
- PCB footprint libraries, 423
- PDC, 471
 - variants, 341
- PDF format output, 201, 354
- Perform operation on locked items, 61
- Photo plots, 353
- Pin
 - alphanumeric pins, 459
 - part editor page, 459
 - pin name order, 466
 - pin type rules, 148
 - swapping, 260
 - type rules, 149
 - types, 148, 459
- Pin networks, 128
- Placement
 - area, 296, 444
 - clearance, 296
 - clearance area, 444
- Placing components
 - PCB, 248
 - place around board, 244
- Plotting

- board outline, 370
- combining plots, 390
- composite plots, 380
- creating plots, 368
- drill drawings, 385
- electrical layers, 370
- full power planes, 374
- multiple plots, 391
- NC drill files, 384
- negative plots, 363
- only plot items, 363
- outputs, 353
- overview, 354
- PDF format, 354
- plot groups, 360
- plot isolation, 363
- plot transformations, 391
- positioning plots, 391
- positive plots, 363
- schematics, 195
- settings, 365
- silkscreen layers, 372
- solder paste masks, 373
- solder resist masks, 373
- step and repeat, 358
- step offset, 359
- to file, 354
- variants, 342
- wizard, 360
- Polygon select, 46
- Pouring copper, 302
- Power and ground symbols, 159
- Power planes, 374
 - composite plots, 380
 - connection, 307
 - split, 381
- Preview bar, 25
- Printing
 - active PDF files, 201
 - PCB, 331
 - schematics, 194
- Profile files, 100
 - loading, 100
 - PCB, 233
 - saving, 101
 - schematic, 121
- Prompt window, 18
- Properties
 - attributes, 53
 - component PCB, 254
 - design, 86
 - dynamic inspector bar, 37
 - multi-item, 52
- Pull tight routing mode, 266

- Pulsonix Database Connection (PDC), 471
- Pulsonix vault, 111, 471
- Pushing
 - components, 251
 - direction, 252
 - push mode, 251
- R**
- Reading gerber files, 416
- Redo, 55
- Relative coordinates, 19, 87
- Relays, 470
- Reload from library
 - parts, 130
 - PCB, 238
- Remove isolated islands, 303
- Remove redundant breakout tracks, 282
- Rename
 - nets, 143
 - pages, 184
- Replacing
 - components, 130
 - parts, 130
- Report affected templates, 308
- Report maker, 400
 - variables, 410
- Reports, 399
 - folder, 77
- Resizing shapes, 294
- Resolve net names
 - schematics, 185
- Restore backups, 81
- Restore points, 76, 79
- Restricted movement routing mode, 267
- Reverse editing direction, 277
- Reverse engineer option, 193
- Revision control, 471
- Right mouse menus, 49
- Rotate, 58
 - adjust to readable orientation, 60
 - bus items, 59
 - CAM Plots, 61
 - grouped items, 60
 - one step, 59
 - units, 59
- Routing
 - modes, 263
 - options, 265
 - restricted movement, 267
- Rules, 120
 - technology, 93
- S**
- Save, 78
- Save restore point, 80

- Saving libraries, 79
- Schematic
 - documentation symbols, 155
 - mounting holes, 155
 - symbol editor, 430
 - symbol libraries, 423
- Screen grid, 85
- Security copies, 76, 79
- Segment modes
 - schematics, 136
- Select
 - all, 46
 - all visible, 46
 - Ctrl select, 45
 - cyclic picking, 48
 - double-clicking, 47
 - frame, 46
 - from list, 48
 - line select, 47
 - mode, 44
 - next, 48
 - polygon, 46
 - previous, 48
 - selection methods, 44
 - Shift select, 45
- Selection flags, 48
- Selection mask, 36
- Setting undo levels, 55
- Setting up grids, 84
- Setting up layer spans, 226
- Setup, 14
- Shape information bar, 40, 232
- Shapes
 - areas, 295
 - closed, 286
 - copying, 293
 - cutouts, 297
 - filled/unfilled, 286
 - growing, 293
 - hatched, 286
 - merging, 297
 - open, 286
 - selecting, 289
 - styles, 285, 290
 - types, 285
 - using, 284
- Shift-delete, 66
- Shortcuts
 - keys report, 24
 - shortcut keys, 23
- Show breakouts, 281
- Show design rule clearance, 247
- Shrinking shapes, 293
- Signal paths, 91, 151
- Signal reference, 152
- Signal References, 159
- Silkscreen layers, 372
- Slotted pads, 210
- Snap cursor to grid, 85
- Snapping to grid, 84
- Solder resist masks, 373
- SpaceMouse, 43
- Spacing rules
 - checks, 323
 - setup, 217
- Spice
 - exporting spice netlists, 192
 - spice type attribute, 456
- Split power planes, 381
- Spokes, 222
- Spring back, 253
- Standard reports, 399
- Star point, 152, 161
- Status bar, 18
- STEP
 - model library, 423
- Step and repeat plots, 358
- STEP export, 396
- Straight line shapes, 290
- Stub routes, 277
 - how to insert, 278
- Styles
 - naming, 215
 - net styles, 92
 - overview, 90
- Sub nets, 91, 151
- Surface mounted pads, 445
- SVG export, 396
- Swap
 - gates, 260
 - pins, 261
- Synchronising designs, 326
- T**
- Teardrops, 220, 309
 - inserting, 310
 - removing, 310
- Technology files, 88
 - essential for manufacture, 225
 - hatch styles PCB, 214
 - import spacing rules using csv file, 219
 - layers, 222
 - loading, 98
 - materials, 225
 - PCB, 208
 - rules, 93
 - saving, 89
 - schematic, 118

- spacing rules, 217
- teardrops, 310
- Templates, 302
 - act poured, 306
 - pour on add, 306
 - split power planes, 383
- Testpoints, 152, 161
 - checks, 324
 - grid, 85
 - schematics, 187
- Text, 67
 - 'NOT' function, 71
 - barred text, 71
 - force to upper case, 69
 - variants, 339
 - vertical alignment, 69
- Text callouts, 317
 - variants, 340
- Thermal spokes, 222
- Toggle cursor grid command, 85
- Toggle layers bar, 40
- Toolbars, 21
 - customising, 22
 - docking, 21
 - floating, 21
- Top down design (hierarchy), 173
- Track
 - changing layers, 271
 - changing net names, 272
 - editing, 263
 - grid, 85
 - styles, 271
 - unrouting, 284
- Track & Via Size Limit, 144
- Translate to PCB, 189, 229
- Truetype fonts, 67

U

- Unattach dimensions, 315
- Undo, 55
- Unilateral dimensions, 316
- Uninstall, 16
- Units, 82
- Unlock, 61
 - components, 253
- Unroute track, 284
 - path, 277
- Update PCB, 326
- Use no grid, 85
- User defined grid, 85
- User defined origin, 86
- User defined pads, 209, 212
- User libraries, 427
- Using composite layer spans, 349

- Using shapes, 284
- Using the vault, 471

V

- Variables for report maker, 410

Variants

- assembly variants, 332
- attributes, 338, 339
- cam plot, 342
- components, 339
- database connection, 341
- design properties, 340
- doc shapes, 341
- fitted, 337
- footprints, 338
- layer class, 336
- not-fitted, 337
- part variants, 332
- parts, 338
- plotting, 342
- spreadsheet, 345
- text, 339
- text callouts, 340

- Vault, 111, 471

- admin tools, 114
- insert component, 114

- Verifying power planes, 376

- Vertical text alignment, 69

Vias

- allow automatic changes switch, 280
- changing spans, 279
- grid, 85
- micro-vias, 346

View

- actual size, 44
- all, 44
- board, 44
- power plane, 376
- selection, 44

W

- Web updates, 15

Wildcard

- examples, 95
- wizard, 95

- Working grid, 82, 85

- World view, 29

Z

- ZIP export, 397

- Zoom extents, 44

- Zoom in, 43, 44

- Zoom out, 43, 44

